

JAN-7201S/9201S

Simple ECDIS

Instruction Manual <Function>

| | |
|---|-------|
| Overview | 1 |
| Name and Function of Each Unit | 2 |
| Common Basic Operations | 3 |
| Range and Bearing Measurement Methods | 4 |
| Target Tracking and AIS | 5 |
| Functions of the ECDIS | 6 |
| Route Planning | 7 |
| Route Monitoring | 8 |
| Monitoring a Dragging Anchor | 9 |
| Automatic Sailing (Unsupported) | 10 |
| Operating a Chart | 11 |
| Creating a User Map/ Updating a Chart Manually | 12 |
| Logbook | 13 |
| Setting Up Screen View | 14 |
| Setting Up Alerts | 15 |
| Setting Up the Operation Mode | 16 |
| Adjusting and Setting Up Equipment (for Services) | 17 |
| Playing Back Data Recorded During Navigation [Playback] | 18 |
| Maintenance & Inspection | 19 |
| Failures and After-Sale Services | 20 |
| About Disposal | 21 |
| Specifications | 22 |
| Alert List | APP A |
| Menu List and Materials | APP B |

Contents

Function

| | | |
|------------------|--|------------|
| Section 5 | Target Tracking and TT/AIS | 5-1 |
| 5.1 | Displaying Symbols | 5-1 |
| 5.1.1 | Displaying/hiding target tracking symbols/AIS target symbols | 5-1 |
| 5.1.2 | Types and Definitions of Target Tracking Symbols | 5-2 |
| 5.1.3 | Types and Definitions of AIS Target Symbols | 5-3 |
| 5.1.4 | About AIS AtoN (Aids to Navigation) | 5-7 |
| 5.1.5 | About AIS-SART Information | 5-8 |
| 5.1.6 | About Display Priority of AIS Targets | 5-8 |
| 5.1.7 | Association Target Symbols | 5-10 |
| 5.2 | Preparation | 5-11 |
| 5.2.1 | Setting the Cursor Mode to AUTO Mode | 5-11 |
| 5.2.2 | Setting Vector Length | 5-12 |
| 5.2.3 | Setting up the automatic activation zone (AZ) | 5-13 |
| 5.2.3.1 | Using [New Target Warning] dialog in the [Alert] menu | 5-13 |
| 5.2.3.2 | Using the cursor | 5-14 |
| 5.2.3.3 | Using the EBL/VRM dial for the setting | 5-16 |
| 5.2.4 | Tracked target information display | 5-17 |
| 5.2.5 | Displaying Target ID No. | 5-18 |
| 5.2.6 | Editing tracked target properties | 5-20 |
| 5.2.6.1 | Setting track color of tracked target | 5-20 |
| 5.3 | Setting and Operating AIS | 5-21 |
| 5.3.1 | Enabling AIS Function | 5-21 |
| 5.3.2 | Activating AIS targets (Activate AIS) | 5-21 |
| 5.3.2.1 | Manual activation | 5-21 |
| 5.3.2.2 | Automatic activation | 5-22 |
| 5.3.3 | Deactivating AIS targets | 5-22 |
| 5.3.4 | Displaying AIS information | 5-23 |
| 5.3.5 | Displaying Target ID No. | 5-31 |
| 5.3.6 | Checking and Setting AIS Target Property | 5-32 |
| 5.3.6.1 | Setting track color of AIS target | 5-32 |
| 5.3.7 | Conditions for deciding AIS target to be lost | 5-33 |
| 5.4 | Alert Display | 5-35 |
| 5.4.1 | Gyro set notification (Set Gyro) | 5-36 |
| 5.5 | Setting the Display of Other Ship's Track | 5-37 |
| 5.5.1.1 | Setting track color | 5-37 |
| 5.5.1.2 | Turning on/off other ship's track function | 5-37 |
| 5.5.1.3 | Setting other ship's track colors | 5-37 |

| | | |
|------------------|--|------------|
| 5.5.1.4 | Turning on/off other ship's track display | 5-37 |
| 5.5.1.5 | Setting up a display interval of other ship's track | 5-38 |
| 5.5.1.6 | Clearing other ship's track | 5-38 |
| 5.5.1.7 | Saving and loading other ship's track data..... | 5-38 |
| 5.6 | Entering Own Ship's AIS Voyage Data | 5-39 |
| 5.7 | Editing and Sending AIS Messages..... | 5-40 |
| 5.8 | AIS Message Tray..... | 5-43 |
| 5.8.1 | Displaying the AIS message tray | 5-43 |
| 5.8.2 | Switching message display..... | 5-45 |
| 5.8.3 | Sending a message in the message tray after editing..... | 5-47 |
| 5.9 | Highlighting TT/AIS Symbols | 5-48 |
| 5.10 | Displaying the TT/AIS Target List..... | 5-50 |
| 5.10.1 | Displaying TT/AIS List..... | 5-50 |
| 5.10.1.1 | Switching between a standard window and an extended window | 5-51 |
| 5.10.2 | TT List | 5-53 |
| 5.10.3 | AIS List..... | 5-54 |
| 5.11 | Confirming Own Ship's AIS Information | 5-56 |
| 5.12 | Display of AIS-SART | 5-57 |
| 5.12.1 | Radar screen display example | 5-57 |
| 5.12.2 | Numeric data display example..... | 5-58 |
| Section 6 | Functions of the ECDIS | 6-1 |
| 6.1 | General Flowchart..... | 6-1 |
| 6.1.1 | Work Flowchart While Sailing | 6-2 |
| 6.2 | Starting and Preparing the ECDIS | 6-3 |
| 6.2.1 | Powering on and starting | 6-3 |
| 6.2.2 | Starting the ECDIS..... | 6-4 |
| 6.2.2.1 | Starting the ECDIS from the Task Menu | 6-4 |
| 6.2.2.2 | Starting ECDIS from a non-ECDIS task screen | 6-5 |
| 6.2.3 | Entering an ARCS PIN Number (ARCS Only)..... | 6-6 |
| 6.3 | Moving the Chart..... | 6-7 |
| 6.3.1 | Moving the chart with the [HOME] button | 6-7 |
| 6.3.2 | Moving the chart with the cross-hair cursor | 6-8 |
| 6.3.3 | Moving the chart with the hand cursor..... | 6-9 |
| 6.3.4 | Switching a chart to be displayed by "My Port List" | 6-10 |
| 6.3.5 | Displaying the chart by entering the position | 6-11 |
| 6.4 | Zooming In/Out the Chart..... | 6-12 |
| 6.4.1 | Enlarging a Selected Area (S-57/C-MAP Only) | 6-12 |
| 6.4.2 | Enlarging/reducing a chart with the Zoom function | 6-14 |
| 6.4.2.1 | Enlarging/reducing with the [ZOOM IN]/[ZOOM OUT] key on the trackball operation unit (S-57/C-MAP only)..... | 6-14 |
| 6.4.2.2 | Enlarging/reducing with the zoom slider (S-57/C-MAP only) | 6-14 |

| | | |
|------------------|---|------------|
| 6.4.2.3 | Enlarging/reducing with the [Large]/[Small] buttons (RNC only) | 6-16 |
| 6.4.3 | Switching between scale and range (S-57/C-MAP only) | 6-17 |
| 6.5 | Changing the Object Category (S-57/C-MAP Only) | 6-18 |
| 6.5.1 | Switching object display | 6-19 |
| 6.5.2 | Customizing object display | 6-20 |
| 6.6 | Selecting Motion/Bearing Mode | 6-22 |
| 6.6.1 | Setting motion mode | 6-23 |
| 6.6.2 | Setting Bearing mode (S-57/C-MAP only) | 6-25 |
| 6.7 | Registering and Displaying My Port List | 6-27 |
| 6.7.1 | Registering to My Port List | 6-27 |
| 6.7.2 | Deleting a port | 6-28 |
| 6.8 | Selecting a S-57 chart | 6-29 |
| 6.9 | Selecting an ARCS chart | 6-30 |
| 6.9.1 | Selecting charts from all | 6-30 |
| 6.9.2 | Changing active panels (ARCS only) | 6-31 |
| 6.9.3 | Changing a low resolution chart (ARCS only) | 6-32 |
| 6.9.4 | Changing a high resolution chart (ARCS only) | 6-33 |
| 6.9.5 | Displaying the note and diagram (ARCS only) | 6-34 |
| 6.10 | Multi View Display and Wide Range View Window Display of Charts | 6-35 |
| 6.10.1 | Display of multi view | 6-36 |
| 6.10.1.1 | Displaying multi view | 6-36 |
| 6.10.1.2 | Multi view operation procedure | 6-38 |
| 6.11 | Verifying Object Information (Pick Report Function) | 6-43 |
| 6.11.1 | Pick Report of the S-57 chart | 6-43 |
| 6.11.1.1 | Displaying a Pick Report of the S-57 chart | 6-43 |
| 6.11.1.2 | Verifying Object Information | 6-45 |
| 6.11.1.3 | Verifying Chart Information | 6-50 |
| 6.11.1.4 | Verifying Chart Update History | 6-51 |
| 6.11.2 | Pick report of the C-MAP chart | 6-52 |
| 6.11.3 | Pick report of the ARCS chart | 6-53 |
| 6.12 | Marking the Position of Own Ship with an Event Mark | 6-54 |
| 6.13 | Displaying Radar Images on a Chart by Overlaying (Option) | 6-55 |
| 6.13.1 | Turning On/Off overlay display | 6-56 |
| 6.13.2 | Turning On/Off range ring display | 6-58 |
| 6.13.3 | Turning On/Off bearing scale | 6-59 |
| 6.13.4 | Radar image adjustment | 6-60 |
| 6.14 | Setting a true bearing | 6-61 |
| 6.15 | Setting an own ship's speed | 6-62 |
| 6.15.1 | Switching an own ship's speed sensor | 6-62 |
| 6.15.2 | Entering the ship's heading/own ship's speed manually | 6-63 |
| Section 7 | Route Planning | 7-1 |

| | | |
|---------|---|------|
| 7.1 | Overview of the Route Planning Function..... | 7-2 |
| 7.2 | Setting Route Display..... | 7-3 |
| 7.2.1 | Setting [Route] after selecting [View] - [Options] on the menu..... | 7-3 |
| 7.2.2 | Setting [Settings] - [Route] on the menu..... | 7-5 |
| 7.3 | Starting and Ending the [Route Planning] Dialog Box | 7-9 |
| 7.3.1 | Starting the [Route Planning] dialog box | 7-9 |
| 7.3.2 | Ending the [Route Planning] dialog box..... | 7-9 |
| 7.4 | Name and Function of Each Section of the [Route Planning] dialog Box..... | 7-10 |
| 7.4.1 | Route Planning bar | 7-10 |
| 7.4.2 | Route planning tab..... | 7-15 |
| 7.5 | Saving a Route..... | 7-17 |
| 7.6 | Planning a Route by Using Table Editing..... | 7-21 |
| 7.6.1 | Table editing operation flow | 7-21 |
| 7.6.1.1 | Creating a new route file..... | 7-21 |
| 7.6.1.2 | Editing a route | 7-22 |
| 7.6.2 | Creating a new route file by table editing | 7-23 |
| 7.6.3 | Deleting WPT data..... | 7-25 |
| 7.6.4 | Editing a route by table editing | 7-25 |
| 7.6.4.1 | Inserting WPT | 7-28 |
| 7.6.4.2 | Deleting WPT | 7-28 |
| 7.6.4.3 | Dividing a leg..... | 7-29 |
| 7.6.4.4 | Copying the entire route | 7-29 |
| 7.6.4.5 | Pasting the copied route..... | 7-30 |
| 7.6.4.6 | Inserting the other route | 7-30 |
| 7.6.4.7 | Insert the same WPT as the last WPT | 7-30 |
| 7.7 | Planning a New Route by Graphic Editing..... | 7-31 |
| 7.7.1 | Graphic editing operation flow | 7-31 |
| 7.7.1.1 | Creating a new route file..... | 7-31 |
| 7.7.1.2 | Editing a route file..... | 7-32 |
| 7.7.2 | Creating a new route file by graphic editing | 7-33 |
| 7.7.2.1 | Creating a route by using EBL/VRM | 7-35 |
| 7.7.2.2 | Creating a route by using the assistant circle function..... | 7-37 |
| 7.7.3 | Editing a route by graphic editing | 7-39 |
| 7.7.3.1 | Inserting a WPT between WPTs..... | 7-41 |
| 7.7.3.2 | Moving a WPT | 7-42 |
| 7.7.3.3 | Changing XTD (cross track limit)..... | 7-44 |
| 7.7.3.4 | Adding WPT on the context menu..... | 7-45 |
| 7.7.3.5 | Moving WPT on the context menu | 7-46 |
| 7.7.3.6 | Deleting WPT on the context menu..... | 7-47 |
| 7.7.3.7 | Copying and pasting a route on the context menu..... | 7-48 |
| 7.7.3.8 | Rotating a route on the context menu | 7-49 |
| 7.7.3.9 | Moving a route on the context menu | 7-50 |

| | | |
|------------------|--|------------|
| 7.7.3.10 | Inserting other route on the context menu..... | 7-52 |
| 7.7.3.11 | Inserting WPT between WPTs on the context menu..... | 7-53 |
| 7.7.3.12 | Dividing a leg on the context menu..... | 7-54 |
| 7.7.3.13 | Changing XTD (cross track limit) on the context menu..... | 7-55 |
| 7.8 | Creating an Alternate Route..... | 7-57 |
| 7.8.1 | Creating an alternate route..... | 7-59 |
| 7.8.2 | Saving an alternate route..... | 7-60 |
| 7.8.2.1 | Overwriting without changing a file name..... | 7-60 |
| 7.8.2.2 | Saving by assigning a name..... | 7-61 |
| 7.9 | Checking Route Data..... | 7-62 |
| 7.9.1 | Checking a route based on the safety standards..... | 7-62 |
| 7.9.2 | Checking a route based on the limits..... | 7-66 |
| 7.10 | Navigation Calculation Function..... | 7-68 |
| 7.10.1 | ROT (Rate of Turn)..... | 7-68 |
| 7.10.2 | ETA (Estimated Time of Arrival)..... | 7-68 |
| 7.10.3 | TWOL (Time to Go)..... | 7-69 |
| 7.11 | Importing/Exporting a Route File..... | 7-70 |
| 7.11.1 | Importing a route file..... | 7-70 |
| 7.11.2 | Exporting a route file..... | 7-71 |
| 7.12 | Error Messages that are Displayed when a Route is Created..... | 7-72 |
| Section 8 | Route Monitoring..... | 8-1 |
| 8.1 | Route Monitoring..... | 8-1 |
| 8.1.1 | Starting route monitoring..... | 8-1 |
| 8.1.2 | Ending route monitoring..... | 8-2 |
| 8.2 | Selecting and Deleting Route Files..... | 8-3 |
| 8.2.1 | Selecting a route to be displayed..... | 8-3 |
| 8.2.2 | Deleting a route file..... | 8-4 |
| 8.3 | [Voyage Information] (Voyage Monitoring Information) Dialog Box..... | 8-5 |
| 8.4 | [Voyage Calculation] Dialog Box..... | 8-11 |
| 8.4.1 | Calculating a schedule..... | 8-13 |
| 8.4.2 | Calculating a distance..... | 8-14 |
| 8.4.3 | Example of distance calculation..... | 8-16 |
| 8.5 | Comparing the Data between the Planned Route and the Actual Route..... | 8-18 |
| 8.6 | Verifying Detail Information of WPT..... | 8-20 |
| Section 9 | Monitoring a Dragging Anchor..... | 9-1 |
| 9.1 | Setting a Dragging Anchor Monitoring Area..... | 9-2 |
| 9.1.1 | Setting a dragging anchor monitoring circle..... | 9-2 |
| 9.1.2 | Setting a dragging anchor monitoring polygon..... | 9-4 |
| 9.2 | Starting and Ending Dragging Anchor Monitoring..... | 9-5 |
| 9.2.1 | Starting dragging anchor monitoring..... | 9-5 |
| 9.2.2 | Ending dragging anchor monitoring..... | 9-6 |

| | | |
|-------------------|--|-------------|
| 9.3 | Moving/Editing/Deleting a Dragging Anchor Monitoring Area on the Chart..... | 9-7 |
| 9.3.1 | Changing a size of a dragging anchor monitoring circle on the chart | 9-7 |
| 9.3.2 | Changing a size of a dragging anchor monitoring circle on the context menu..... | 9-8 |
| 9.3.3 | Changing a shape of a dragging anchor monitoring polygon on the chart..... | 9-8 |
| 9.3.4 | Changing a shape of a dragging anchor monitoring polygon on the context menu | 9-9 |
| Section 10 | Automatic Sailing (Option)..... | 10-1 |
| 10.1 | Flow of Starting Automatic Sailing | 10-2 |
| 10.2 | Selecting a Route..... | 10-6 |
| 10.2.1 | Using the existing planned route | 10-6 |
| 10.2.2 | Creating a new route | 10-8 |
| 10.3 | Selecting a Waypoint at which Automatic Sailing Starts..... | 10-10 |
| 10.4 | Starting Automatic Sailing | 10-12 |
| 10.5 | Stopping Automatic Sailing | 10-14 |
| 10.6 | Alerts at Automatic Sailing | 10-15 |
| Section 11 | Operating a Chart..... | 11-1 |
| 11.1 | Updating a Chart Manually..... | 11-3 |
| 11.2 | Displaying/Searching an S-57 Chart [Select S-57 Chart] | 11-4 |
| 11.2.1 | Displaying a chart | 11-4 |
| 11.2.2 | Search a chart..... | 11-5 |
| 11.2.2.1 | Searching the position that is clicked on by the cursor | 11-5 |
| 11.2.2.2 | Searching by using a chart name..... | 11-6 |
| 11.3 | Displaying a Chart by Inputting a Position | 11-7 |
| 11.4 | Confirming/Accepting/Rejecting an S-57 Updated Chart..... | 11-8 |
| 11.5 | Displaying a Date-dependent Object | 11-10 |
| 11.6 | Displaying a Chart Boundary | 11-12 |
| 11.6.1 | Setting a boundary to be displayed on the chart | 11-12 |
| 11.6.2 | Displaying chart information | 11-13 |
| 11.7 | Confirming Temporary/Preliminary Information of an ARCS Chart (ARCS Only)..... | 11-14 |
| 11.8 | Adjusting an ARCS Chart Position (ARCS Only)..... | 11-15 |
| 11.8.1 | Offsetting an ARCS chart..... | 11-15 |
| 11.8.2 | Transforming a geodetic datum of an ARCS chart to WGS-84 | 11-17 |
| 11.9 | Displaying a Chart Abbreviation List | 11-21 |
| 11.10 | Displaying an ENC Update Status Report..... | 11-22 |
| 11.11 | Displaying update data of the C-MAP chart..... | 11-27 |
| 11.12 | Displaying license information of C-MAP..... | 11-29 |
| 11.12.1 | Setting license information display to ON..... | 11-29 |
| 11.12.2 | C-MAP license information | 11-30 |
| 11.12.2.1 | License information display timing | 11-30 |
| 11.12.2.2 | License information | 11-32 |
| 11.13 | Displaying ECDIS Chart 1..... | 11-33 |

| | | |
|-------------------|--|-------------|
| 11.13.1 | Displaying ECDIS Chart 1 | 11-33 |
| 11.13.2 | Confirm display of ECDIS Chart 1 | 11-34 |
| 11.14 | Displaying differences at chart update | 11-36 |
| 11.14.1 | Displaying differences at S-57 chart update | 11-36 |
| 11.14.2 | Displaying differences at C-MAP chart update | 11-37 |
| 11.15 | Chart pick report..... | 11-37 |
| 11.16 | Maintaining a Chart..... | 11-38 |
| Section 12 | Creating a User Chart/ Updating a Chart Manually | 12-1 |
| 12.1 | Creating/Editing a User Map | 12-3 |
| 12.1.1 | Display the "User Chart " menu | 12-4 |
| 12.1.2 | Display the File Operation submenu..... | 12-5 |
| 12.1.2.1 | [File Operation] dialog box..... | 12-5 |
| 12.1.3 | Creating a new user chart..... | 12-7 |
| 12.1.4 | Editing the existing user chart..... | 12-8 |
| 12.1.4.1 | Editing the user chart that is currently displayed..... | 12-8 |
| 12.1.5 | Displaying a user chart | 12-9 |
| 12.1.6 | Operating a user chart file | 12-10 |
| 12.1.6.1 | Deleting a user chart file..... | 12-10 |
| 12.1.6.2 | Copying a user chart file..... | 12-10 |
| 12.1.6.3 | Importing a user chart file | 12-11 |
| 12.1.6.4 | Exporting a user chart file..... | 12-11 |
| 12.1.6.5 | Merging multiple user chart files..... | 12-12 |
| 12.1.6.6 | Performing geodetic datum conversion..... | 12-13 |
| 12.2 | Using Map Creation Tools (User Chart Creation/Editing) | 12-14 |
| 12.2.1 | User chart information bar | 12-14 |
| 12.2.1.1 | Displaying a user chart information bar..... | 12-14 |
| 12.2.2 | Drawing toolbar..... | 12-15 |
| 12.2.3 | Selecting an object type..... | 12-16 |
| 12.2.3.1 | Using a user chart object..... | 12-17 |
| 12.2.4 | Selecting a color of an object..... | 12-18 |
| 12.2.5 | Creating an object in the EBL/VRM mode | 12-18 |
| 12.2.6 | Creating an object by specifying latitude and longitude | 12-19 |
| 12.2.6.1 | Creating an object of symbol/circle/ellipse/arc/arrow/text | 12-19 |
| 12.2.6.2 | Creating an object of simple line/polygon/highlight | 12-20 |
| 12.2.7 | Deleting an object..... | 12-20 |
| 12.2.8 | Object property dialog box..... | 12-21 |
| 12.2.8.1 | Selecting an object | 12-21 |
| 12.2.8.2 | Setting a comment..... | 12-22 |
| 12.2.9 | Changing an object display scale range | 12-23 |
| 12.2.10 | Moving an object..... | 12-23 |
| 12.3 | Updating a Chart Manually (ARCS/C-MAP) | 12-25 |
| 12.3.1 | Displaying the Manual Update submenu | 12-26 |

| | | |
|----------|--|-------|
| 12.3.2 | Selecting a chart to be updated | 12-27 |
| 12.3.2.1 | Displaying a chart list for the C-MAP chart..... | 12-28 |
| 12.3.2.2 | Searching the position that is clicked on with the cursor..... | 12-28 |
| 12.3.2.3 | Searching a chart with the chart name..... | 12-29 |
| 12.3.2.4 | Displaying the chart screen that is selected from the list (ARCS only)..... | 12-29 |
| 12.3.2.5 | Absence/expiration of the C-MAP chart license..... | 12-29 |
| 12.3.3 | Updating a chart manually..... | 12-30 |
| 12.3.4 | Displaying selected chart only | 12-31 |
| 12.3.5 | Displaying the object/redisplaying the hidden object..... | 12-31 |
| 12.4 | How to Use the Map Creation Tools (At Manual Update of ARCS/C-MAP) | 12-32 |
| 12.4.1 | Deleting or hiding an object | 12-32 |
| 12.4.2 | Selecting an object type..... | 12-33 |
| 12.5 | Creating an Object (At Manual Update of ARCS/C-MAP) | 12-34 |
| 12.5.1 | Creating a symbol object (Symbol)..... | 12-35 |
| 12.5.1.1 | Creating an object by specifying the latitude and longitude..... | 12-35 |
| 12.5.1.2 | Creating an object with EBL/VRM operation..... | 12-36 |
| 12.5.2 | Creating a simple line and a Alerts line (Line object)..... | 12-37 |
| 12.5.2.1 | Creating a vertex by entering the position..... | 12-40 |
| 12.5.2.2 | Creating an object with EBL/VRM operation..... | 12-40 |
| 12.5.3 | Creating a circle, ellipse, and an arc (Line object)..... | 12-41 |
| 12.5.3.1 | Creating an object by specifying a position for the center and size of the object..... | 12-43 |
| 12.5.4 | Creating a polygon and Alerts area (Area object)..... | 12-44 |
| 12.5.4.1 | Creating a vertex by entering the position..... | 12-46 |
| 12.5.4.2 | Creating an object with EBL/VRM operation..... | 12-46 |
| 12.5.5 | Creating circle, ellipse, and fan areas (Area object)..... | 12-48 |
| 12.5.5.1 | Creating an object by specifying the center position and the object size..... | 12-50 |
| 12.5.6 | Creating a text (Text object)..... | 12-51 |
| 12.5.6.1 | Creating a text by specifying the latitude and longitude..... | 12-52 |
| 12.5.6.2 | Creating a text with EBL/VRM operation..... | 12-52 |
| 12.5.6.3 | Editing a text..... | 12-53 |
| 12.5.6.4 | Editing a template..... | 12-53 |
| 12.5.6.5 | Changing a text angle..... | 12-55 |
| 12.5.7 | Creating an arrow (Line object) | 12-56 |
| 12.5.7.1 | Creating an object by specifying the starting point/ending point position coordinates | 12-57 |
| 12.5.7.2 | Drawing an object with EBL/VRM operation | 12-58 |
| 12.5.8 | Creating Mariner's Mark/Line drawing objects..... | 12-59 |
| 12.5.8.1 | Information mark..... | 12-59 |
| 12.5.8.2 | Clearing line..... | 12-61 |
| 12.5.8.3 | Tidal Stream mark | 12-64 |
| 12.5.8.4 | Highlighted display | 12-66 |
| 12.6 | Collective Deletion of Objects [Delete by Type/Color] | 12-72 |

| | | |
|-----------|--|--------|
| 12.7 | Managing/Editing Objects [Mark Line/List]..... | 12-73 |
| 12.7.1 | Displaying the [Mark/Line List] dialog box | 12-73 |
| 12.7.2 | Displaying a user chart list..... | 12-74 |
| 12.7.2.1 | Displaying an object on a chart | 12-74 |
| 12.7.2.2 | Deleting an object..... | 12-74 |
| 12.7.3 | Displaying a Mariner's Mark/Line List | 12-74 |
| 12.7.3.1 | Displaying an object on a chart | 12-75 |
| 12.7.3.2 | Deleting an object..... | 12-75 |
| 12.7.3.3 | Deleting objects collectively from an object list | 12-75 |
| 12.8 | Updating a Chart Manually (S-57/S-63)..... | 12-76 |
| 12.8.1 | Displaying the Manual Update submenu | 12-77 |
| 12.8.2 | Selecting a chart to be updated | 12-79 |
| 12.8.2.1 | Searching the position that is clicked on with the cursor..... | 12-80 |
| 12.8.2.2 | Searching a chart with the chart name | 12-81 |
| 12.8.3 | Updating a chart manually | 12-81 |
| 12.8.4 | Displaying selected chart only | 12-82 |
| 12.8.5 | Entering an editor of the manual update | 12-82 |
| 12.9 | How to Use the Map Creation Tools (at Manual Update of S-57/S-63) | 12-83 |
| 12.9.1 | Deleting or hiding an object | 12-83 |
| 12.9.2 | Selecting an object type..... | 12-84 |
| 12.10 | Creating an Object (S-57/S-63) | 12-85 |
| 12.10.1 | Creating a symbol object (Symbol)..... | 12-86 |
| 12.10.1.1 | Creating an object by specifying the latitude and longitude..... | 12-87 |
| 12.10.1.2 | Creating an object with EBL/VRM operation..... | 12-87 |
| 12.10.2 | Creating a simple line and Alerts line (Line object)..... | 12-89 |
| 12.10.2.1 | Creating a vertex by entering the position | 12-92 |
| 12.10.2.2 | Creating an object with EBL/VRM operation..... | 12-92 |
| 12.10.3 | Creating a circle, ellipse, and an arc (Line object)..... | 12-93 |
| 12.10.3.1 | Creating an object by specifying a position for the center and size of the object | 12-95 |
| 12.10.4 | Creating a polygon and Alerts area (Area object)..... | 12-96 |
| 12.10.4.1 | Creating a vertex by entering the position | 12-98 |
| 12.10.4.2 | Creating an object with EBL/VRM operation..... | 12-99 |
| 12.10.5 | Creating circle, ellipse, and fan areas (Area object)..... | 12-100 |
| 12.10.5.1 | Creating an object by specifying the center position and the object size | 12-102 |
| 12.10.6 | Creating a text (Text object)..... | 12-103 |
| 12.10.6.1 | Creating a text by specifying the latitude and longitude..... | 12-104 |
| 12.10.6.2 | Creating a text with EBL/VRM operation..... | 12-104 |
| 12.10.6.3 | Editing a text..... | 12-105 |
| 12.10.6.4 | Editing a template..... | 12-105 |
| 12.10.6.5 | Changing a text angle | 12-107 |
| 12.10.7 | Creating an arrow (Line object) | 12-108 |
| 12.10.7.1 | Creating an object by specifying the starting point/ending point position | |

| | |
|--|-------------|
| coordinates | 12-109 |
| 12.10.7.2 Drawing an object with EBL/VRM operation | 12-110 |
| 12.10.8 Property of a Sounding object | 12-111 |
| 12.10.9 Editing attributes of an object | 12-112 |
| 12.10.9.1 Type E | 12-112 |
| 12.10.9.2 Type L..... | 12-113 |
| 12.10.9.3 Type F | 12-113 |
| 12.10.9.4 Type I..... | 12-114 |
| 12.10.9.5 Type A/S..... | 12-114 |
| 12.10.10 Highlighted display of an object..... | 12-115 |
| 12.10.11 Reviewing manual update | 12-118 |
| 12.10.12 Object Delete function | 12-122 |
| 12.10.13 Object Remove function | 12-123 |
| 12.11 Displaying a Pick Report of Manual Update Objects | 12-124 |
| Section 13 Logbook..... | 13-1 |
| 13.1 Browsing a Logbook..... | 13-1 |
| 13.1.1 Event detail information | 13-3 |
| 13.2 Editing a Logbook | 13-5 |
| 13.2.1 Adding an event..... | 13-5 |
| 13.2.2 Editing event detail information..... | 13-6 |
| 13.3 Outputting Event Data..... | 13-7 |
| 13.3.1 Outputting a logbook as a file | 13-7 |
| Section 14 Setting up Screen View | 14-1 |
| 14.1 Setting Chart Display Mode (Multi View Mode) | 14-2 |
| 14.1.1 Setting Multi-Screen..... | 14-2 |
| 14.2 Setting Screen Display Options | 14-3 |
| 14.2.1 Setting up the display of Own Ship symbol | 14-5 |
| 14.2.2 Setting up the display own ship's track..... | 14-8 |
| 14.2.3 Setting up the display of Route Monitoring..... | 14-10 |
| 14.2.4 Changing the color of the alternative route..... | 14-12 |
| 14.2.5 Setting up the display of User Map..... | 14-13 |
| 14.2.6 Setting up the display of Mariner's Mark Line..... | 14-15 |
| 14.2.7 Setting up Radar Overlay and Transparency of Echo/Trails | 14-16 |
| 14.2.8 Setting up the display of TT/AIS Target | 14-17 |
| 14.2.9 Setting up the display of other ship's track | 14-20 |
| 14.2.10 Setting up the display of Chart Common..... | 14-25 |
| 14.2.11 Setting up the display of Chart..... | 14-34 |
| 14.2.12 Setting up AIO display | 14-45 |
| 14.2.13 Set display of danger detection highlight..... | 14-46 |
| 14.2.14 Setting up the display of Range/Bearing Measurement Function | 14-48 |
| 14.2.15 Setting up the display of unit of setting value | 14-50 |

| | | |
|-------------------|---|-------------|
| 14.2.16 | Setting up display of Own Ship Track Control, display format of Own Ship/Cursor Position and display of Sub-Information dialog | 14-52 |
| 14.2.17 | Setting up the Water Depth display | 14-53 |
| 14.2.18 | Setting up the Rudder graph..... | 14-54 |
| 14.2.19 | Setting up the Gyro/Rudder graph..... | 14-55 |
| 14.2.20 | Setting up the Engine Graph | 14-56 |
| 14.2.21 | Setting up the graph range of the ROT slide bar | 14-57 |
| Section 15 | Setting up Alerts | 15-1 |
| 15.1 | Selecting Setting Items | 15-1 |
| 15.1.1 | Displaying the [Alert] dialog box | 15-1 |
| 15.1.2 | Selecting a setting item..... | 15-2 |
| 15.2 | Target Automatic Activation Conditions..... | 15-3 |
| 15.2.1 | Switching AZ1/AZ2 to enable/disable | 15-4 |
| 15.2.1.1 | Enabling AZ1 or AZ2..... | 15-4 |
| 15.2.1.2 | Disabling AZ1 or AZ2..... | 15-4 |
| 15.3 | Depth/Safety Contour Alert Generation Conditions | 15-5 |
| 15.4 | Setting up Look Ahead | 15-7 |
| 15.4.1 | Switching to enable/disable a danger detection vector/sector | 15-8 |
| 15.4.2 | Setting up the size of a danger detection vector | 15-8 |
| 15.4.3 | Setting up the size of a danger detection sector | 15-8 |
| 15.5 | Area Alert Generation Conditions | 15-9 |
| 15.6 | Track Control Alert Generation Conditions | 15-11 |
| 15.7 | Position Integrity Alert Generation Conditions | 15-12 |
| 15.7.1 | Setting up the generation condition of the POSN(Deviation) warning..... | 15-12 |
| 15.7.2 | Setting up the generation condition of the POSN(Jump) caution..... | 15-13 |
| 15.7.3 | Setting up the generation condition of the HDOP exceeded Maintenance Information | 15-13 |
| 15.8 | Setting up Alert Processing | 15-14 |
| Section 16 | Setting up the Operation Mode..... | 16-1 |
| 16.1 | Basic Operation of the [Settings] Dialog Box..... | 16-1 |
| 16.2 | Basic Settings for Radar Signal Processing | 16-4 |
| 16.3 | Settings of radar signal processing..... | 16-6 |
| 16.4 | Setting up Association..... | 16-7 |
| 16.5 | Setting up Own Ship's Dynamic Trait..... | 16-8 |
| 16.6 | Setting up an AIS/TT Filter | 16-9 |
| 16.7 | Setting up Other Ship's Track Function to ON/OFF..... | 16-11 |
| 16.8 | Setting up Parameter Values at Route Planning Creation..... | 16-12 |
| 16.9 | Setting up Parameter Values for Automatic Sailing | 16-14 |
| 16.10 | Setting up Parameter Values for Predicted Route | 16-17 |
| 16.11 | Setting Chart Operation | 16-19 |

| | | |
|-------|---------------------------------------|-------|
| 16.12 | Setting up Logbook | 16-21 |
| 16.13 | Setting NAVTEX | 16-24 |
| 16.14 | Setting up Navigation Equipment..... | 16-29 |
| 16.15 | Setting up Color and Brightness | 16-30 |
| 16.16 | Setting Sounds..... | 16-34 |
| 16.17 | Setting up Key Assignment | 16-36 |
| 16.18 | Setting Preferences Information | 16-39 |
| 16.19 | Setting up Screen Capture..... | 16-48 |

Section 5 Target Tracking and TT/AIS

This section explains Target Tracking (hereinafter, referred to as target tracking or TT) and Automatic Identification System (hereinafter referred to as AIS).

5

CAUTION



Use the target tracking function as your navigation aid. Final decision on the ship operation must be made by the ship operator himself.

If you depend entirely on the information of the target tracking function for the final decision on ship operation, an accident may occur.

An error may be contained in the vector, target value data and alarm indicated by the target tracking function. Further, the target not detected by radar cannot be captured or tracked.

If you depend entirely on the information of the radar for the final decision on ship operation, such an accident as collision or stranding may result.

5.1 Displaying Symbols





This section describes the symbols that are used for target tracking and AIS.

5.1.1 Displaying/hiding target tracking symbols/AIS target symbols

In the display setting at the time of shipment from the factory, the display of target tracking symbols and of the AIS target symbols is enabled. However, choosing [Options] – [Target] from the View menu can switch between display and hide.

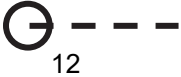
For the details, refer to "14.2.7 Setting up the display of TT/AIS target".

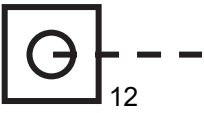

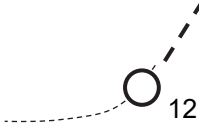







5.1.2 Types and Definitions of Target Tracking Symbols







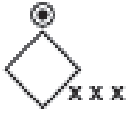
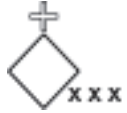





| Symbol | Definition | Remarks |
|---|----------------------------|---|
|  | Initial acquisition target | This symbol is displayed until the vector is displayed after target acquisition. |
|  | Tracked target | This means a tracked target. |
|  | Dangerous target | The alarm sounds. The alarm message (CPA/TCPA) turns red and blinks. The symbol is enlarged and displayed in red. |
|  | Numeric displayed target | When the numeric data is displayed, the target symbol is enclosed in a square. |
|  | Lost target | The alarm sounds. The alarm message (Lost) turns orange and blinks. The symbol turns red. |
|  | Past position | The past positions of an AIS target are displayed as well as the target tracking symbol. |
|  | Target track | The track of another ship as an AIS target is displayed as well as the target tracking symbol. |













Memo











When a target acquired from RADAR is displayed on the ECDIS screen, the ID is prefixed by "T1-" or "T2-" (such as "T1-12" and "T2-12"). On the RADAR screen, only the ID is displayed, not the symbol.



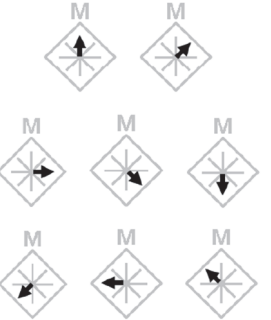

5.1.3 Types and Definitions of AIS Target Symbols

| Symbol | Definition | Remarks |
|---|---|--|
|  | Sleeping target | This symbol is displayed when received data is valid. The direction of the triangle's vertex indicates the target's heading or course. |
|  | Target in pause state | When CTW/STW of the target cannot be received, the symbol is displayed in a broken line. |
|  | Activated target | The heading direction is displayed with a solid line, and the course vector is displayed with a dotted line. The line perpendicular to the heading direction indicates the direction to which the course is to be changed. This line may not be displayed. |
|  | Activated target | When CTW/STW of the target cannot be received, the symbol is displayed in a broken line. |
|  | Outline display | The outlines of ships are displayed scaled down. |
|  | Numeric displayed target | When the numeric data is displayed, the target symbol is enclosed in a square. |
|  | Activated AIS-SART target | Displayed by the same color as AIS symbol. |
|  | Numerical display AIS-SART target | When the numeric data is displayed, the target symbol is enclosed in a square. |
|  | Physical AIS AtoN target (Racon) | The target No./AtoN name (xxx) is displayed next to the symbol. |
|  | Physical AIS AtoN target (Emergency wreck mark) | The target No./AtoN name (xxx) is displayed next to the symbol. |
|  | Physical AIS AtoN target (North cardinal mark) | The target No./AtoN name (xxx) is displayed next to the symbol. |

| Symbol | Definition | Remarks |
|---|--|---|
|  | Physical AIS AtoN target (East cardinal mark) | The target No./AtoN name (xxx) is displayed next to the symbol. |
|  | Physical AIS AtoN target (South cardinal mark) | The target No./AtoN name (xxx) is displayed next to the symbol. |
|  | Physical AIS AtoN target (West cardinal mark) | The target No./AtoN name (xxx) is displayed next to the symbol. |
|  | Physical AIS AtoN target (Port hand mark) | The target No./AtoN name (xxx) is displayed next to the symbol. |
|  | Physical AIS AtoN target (Starboard hand mark) | The target No./AtoN name (xxx) is displayed next to the symbol. |
|  | Physical AIS AtoN target (Isolated danger) | The target No./AtoN name (xxx) is displayed next to the symbol. |
|  | Physical AIS AtoN target (Safe water) | The target No./AtoN name (xxx) is displayed next to the symbol. |
|  | Physical AIS AtoN target (Special mark) | The target No./AtoN name (xxx) is displayed next to the symbol. |
|  | Physical AIS AtoN target (Off position) | The symbol and target No./AtoN name (xxx) nearby the symbol are indicated in yellow. |
|  | Physical AIS AtoN target (On position) | The target No./AtoN name (xxx) is displayed next to the symbol. |
|  | Physical AIS AtoN target (Numerical display) | When the numeric data is displayed, the target symbol is enclosed in a square. |
|  | Physical AIS AtoN target (Flood light abnormality) | "Unlit" is displayed in yellow at the top of the symbol. The target No./AtoN name (xxx) is displayed nearby the symbol. |

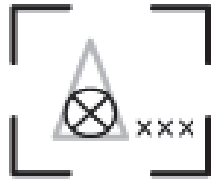
| Symbol | Definition | Remarks |
|---|---|---|
|  | Physical AIS AtoN target (radar beacon abnormality) | "Racon err" is displayed in yellow at the top of the symbol. The target No./AtoN name (xxx) is displayed nearby the symbol. |
|  | Virtual AIS AtoN target (Emergency wreck mark) | The target No./AtoN name (xxx) is displayed next to the symbol. |
|  | Virtual AIS AtoN target (North cardinal mark) | The target No./AtoN name (xxx) is displayed next to the symbol. |
|  | Virtual AIS AtoN target (East cardinal mark) | The target No./AtoN name (xxx) is displayed next to the symbol. |
|  | Virtual AIS AtoN target (South cardinal mark) | The target No./AtoN name (xxx) is displayed next to the symbol. |
|  | Virtual AIS AtoN target (West cardinal mark) | The target No./AtoN name (xxx) is displayed next to the symbol. |
|  | Virtual AIS AtoN target (Port hand mark) | The target No./AtoN name (xxx) is displayed next to the symbol. |
|  | Virtual AIS AtoN target (Starboard hand mark) | The target No./AtoN name (xxx) is displayed next to the symbol. |
|  | Virtual AIS AtoN target (Isolated danger) | The target No./AtoN name (xxx) is displayed next to the symbol. |
|  | Virtual AIS AtoN target (Safe water) | The target No./AtoN name (xxx) is displayed next to the symbol. |
|  | Virtual AIS AtoN target (Special mark) | The target No./AtoN name (xxx) is displayed next to the symbol. |
|  | Virtual AIS AtoN target (Numerical display) | When the numeric data is displayed, the target symbol is enclosed in a square. |
|  | Virtual AIS AtoN target (Intended location of missing AtoN) | "Missing" is displayed in yellow at the top of the symbol. The target No./AtoN name (xxx) is displayed nearby the symbol. |

| Symbol | Definition | Remarks |
|---|--|--|
|  | Physical mobile AIS AtoN target | The target No./AtoN name (xxx) is displayed next to the symbol. |
|  | Virtual mobile AIS AtoN target | The target No./AtoN name (xxx) is displayed next to the symbol. |
|  | Virtual AtoN Error | It is an icon when RACON err/off is combined. |
|  | Mobile AIS AtoN target (AtoNStatus = 0xae) | Self-propelled, but direction not reported or unavailable (AtoN Status bits 1010111x): |
|  | Mobile AIS AtoN target (AtoNStatus = 0xaa) | Tethered (AtoN Status bits 1010101x): |
|  | Mobile AIS AtoN target (COG information is provided) | If COG information is provided, it shall be presented with an arrow pointed in coarse direction of COG within $\pm 22,5^\circ$ sectors as defined by AtoN Status bits. |
|  | AIS SAR aircraft (fixed wing) | Displayed by the same color as AIS symbol. |
|  | Numerical display AIS SAR aircraft (fixed wing) | When the numeric data is displayed, the target symbol is enclosed in a square. |
|  | AIS SAR aircraft (helicopter) | Displayed by the same color as AIS symbol. |
|  | Numerical display AIS SAR aircraft (helicopter) | When the numeric data is displayed, the target symbol is enclosed in a square. |
|  | AIS SAR ship | Displayed by the same color as AIS symbol. |

| Symbol | Definition | Remarks |
|---|---|---|
|  | Numerical display AIS SAR ship | When the numeric data is displayed, the target symbol is enclosed in a square. |
|  | AIS coastal base station | Displayed by the same color as AIS symbol. |
|  | Numerical display AIS coastal base station | When the numeric data is displayed, the target symbol is enclosed in a square. |
|  | Call or unread message symbol (Example: Call or unread message symbol with AIS Target) | Received call or unread message shall be presented by having two increasing centered 1/8 arcs drawn using a thin solid line at upper right-hand side of the AIS target symbol, AIS AtoN physical symbol, Base station symbol etc. Displayed by the same color as AIS symbol. |

5.1.4 About AIS AtoN (Aids to Navigation)

AIS AtoN is a system that displaying aid to navigation like a lighthouse, light buoy or unreal aid to navigation on the display unit on ships using AIS receiver.

There are following two kinds of AIS AtoN.

| AIS AtoN type | Function | Operation example |
|----------------------|--|--|
| Physical AIS AtoN | Installs the AIS on real aid to navigation, and displays its location on the display unit on ships. | In low visibility, receiving the Physical AIS AtoN symbols facilitates identification of the light location and light buoy. |
| Virtual AIS AtoN | Displays virtual aid to navigation on the display unit on ships according to the signals transmitted from the AIS station on the land. | In the sea area where installation of the light buoy is difficult, the Virtual AIS AtoN symbols are displayed as virtual light buoys that are used as targets for getting to the destination. This system can also be used as the aid substituted for the aid to navigation damaged by natural disasters. |
| Physical Mobile AtoN | A mobile AtoN is defined as a non-fixed or un-moored AtoN; it does not include a fixed or moored buoy that is adrift from its station, temporarily or otherwise. | For hazards with a low profile or partly submerged and where visual observations are primarily undertaken from the air, an additional mark, such as a circular symbol, can be added. |
| Virtual Mobile AtoN | A virtual mobile AtoN electronically marks a hazard using an AIS Virtual AtoN message. | A virtual mobile AtoN only be used when there is capability to automatically update the position of the hazard in, or near, real time. |

5.1.5 About AIS-SART Information

The AIS-SART function enables information about the location of wrecked ship to be displayed on the screen.

For the details, refer to "5.12 Display of AIS-SART".

5.1.6 About Display Priority of AIS Targets

Up to 460*1 targets can be displayed in total of activated and sleeping AIS targets. Up to 460 activated AIS targets can be displayed in the total.

When 95% of the maximum display count is exceeded, "AIS 95% Capacity" alert occurs. When the maximum display count is exceeded, "AIS maximum capacity" alert occurs.

When there is an AIS target of 460*1 or more, the display is made according to the following priority order.

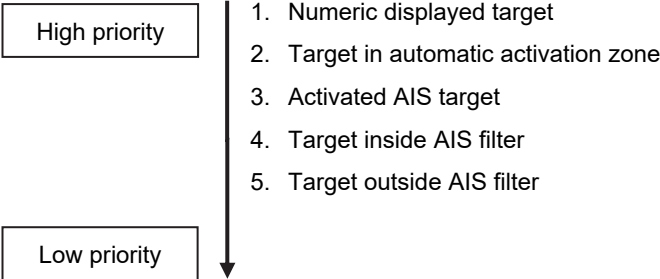

*1: The maximum number of AIS targets displayed can be changed to the option of 1000 targets.

If the number of targets at the same priority level exceeds the allowable maximum, they are displayed in the following priority order:

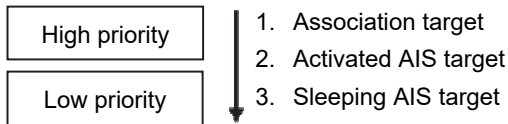

Memo

Maximum display number is sum of Class A AIS and Class B AIS.

Class A: The AIS that must be installed in the large ships specified in the SOLAS Convention.

Class B: The AIS for which medium and small sized vessels and fishing vessels are targeted.

<AIS Capacity>

AIS target= display:460 or 960, processing = 460 or 960

95%,Full: Caution (See 5.4 for alerts.)

AIS data report=20

Full: Information (See 5.13.2 for alerts.)

AIS locating device=20

Full: Information (See 5.14.2 for alerts.)

The AIS target number depends on the MAX AIS Number of installed licenses. Check the installed license in Menu - Maintenance - System information - Functionality.

- AIS target = 460 (MAX AIS Number = 500)

- AIS target = 960 (MAX AIS Number = 1000)

5.1.7 Association Target Symbols

When the tracked target and AIS target are determined to be the same targets, the association symbols are displayed as follows.

Symbol display for high-priority tracked targets



12 — Association targets

Symbol display for high-priority AIS targets



AIS12 — Association targets

When the tracked target and AIS target are determined to be the same targets, the tracked target or AIS target that are displayed on a higher priority basis can be set.

- 1 Right-click on the tracked target with association displayed.**
The context menu appears.
- 2 Click on [Property] in the context menu.**
The [TT Target INFO] or [AIS Target INFO] dialog appears.
- 3 Select [AIS] or [TT] from the [Priority] combo box.**

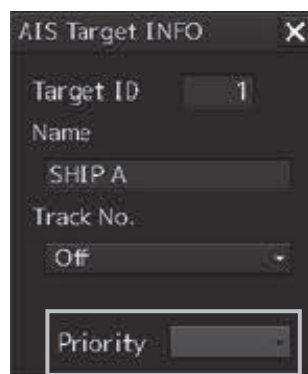
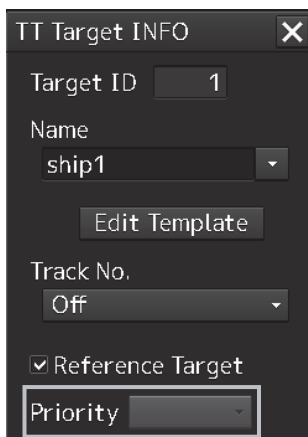

[AIS]: The AIS target is displayed on a higher priority basis.

[TT]: The tracked target is displayed on a higher priority basis.

5.2 Preparation

5.2.1 Setting the Cursor Mode to AUTO Mode

If the cursor mode is set to the AUTO mode, various TT/AIS functions can be executed quickly.

- 1 Click on the [AUTO] (cursor mode selection) button on the left toolbar.



The cursor mode changes to the AUTO mode.

The [AUTO] mode performs operation in accordance with the object at the cursor position when clicked.

For the details, refer to "3.14 Cursor AUTO Mode".

5.2.2 Setting Vector Length

The Vector Length of a target is proportional to its speed, and the vector time can be switched in a range of 1 to 120 minutes.

The following figure shows an example in which the Vector Length is set to 6 min, and the tip of the vector represents the target's position expected to reach 6 minutes later.

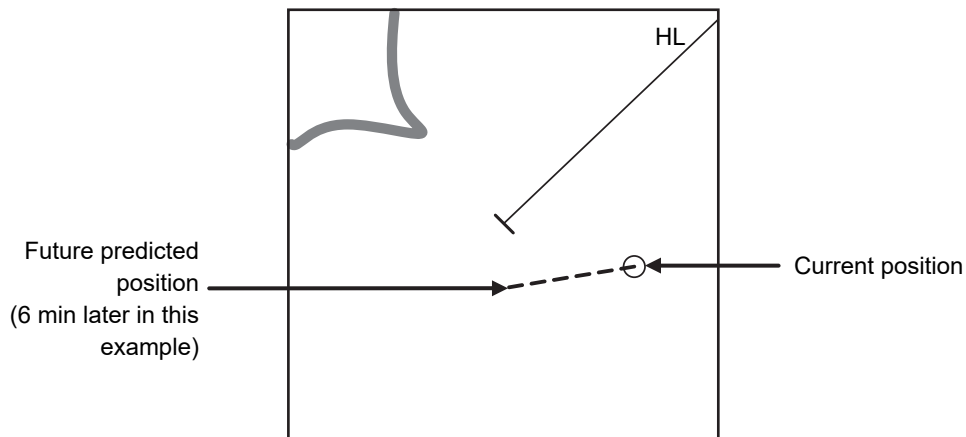

The Vector Length is set in min in the range from 1 min to 120 min.

- 1 Click on the Vector Length input box on the bottom left of the screen.



Vector Length input box

- 2 Enter the Vector Length.

5.2.3 Setting up the automatic activation zone (AZ)

Auto activation zone has the shape of sector set up according to the angle and distance as shown in the following figure.

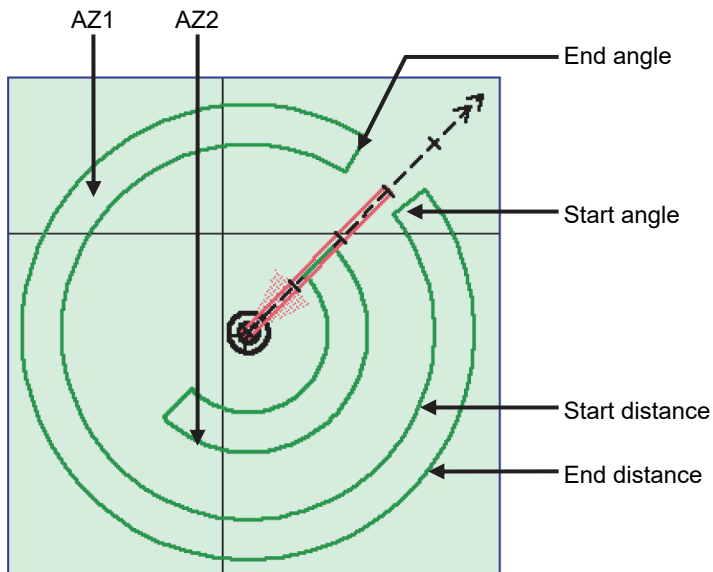

Example of automatic/activation zone (AZ)

Automatic activation zone (AZ) is set up using the following three methods.

- (1) Use the [New Target Warning] dialog in the [Alert] menu.
- (2) Use the cursor.
- (3) Use the EBL/VRM dial.

5.2.3.1 Using [New Target Warning] dialog in the [Alert] menu

- 1** Click on the [Menu] button on the left toolbar.
The menu is displayed.
- 2** Click [Alert] - [New Target Alarm] on the menu.
The [New Target Alarm] dialog is displayed.
- 3** To set up AZ1, select the [Use AZ1] check box. To set up AZ2, select the [Use AZ2] check box.

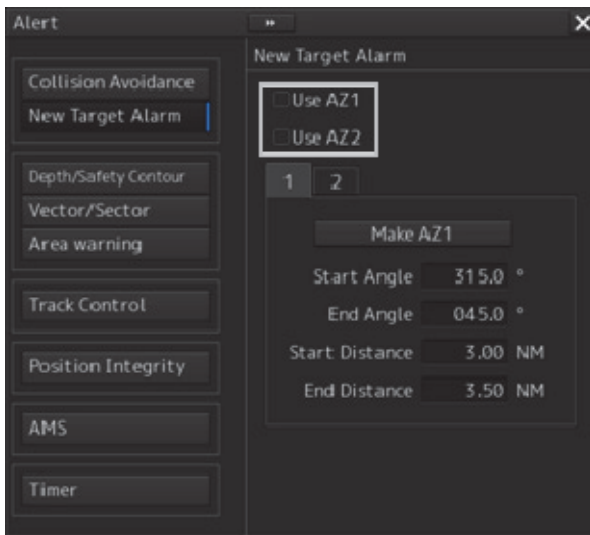

- 4** To set up [Use AZ1], click on the [1] tab. To set up [Use AZ2], click on the [2] tab. Their respective setting items are displayed.
- 5** Enter the start angle, end angle, start distance and end distance of AZ.

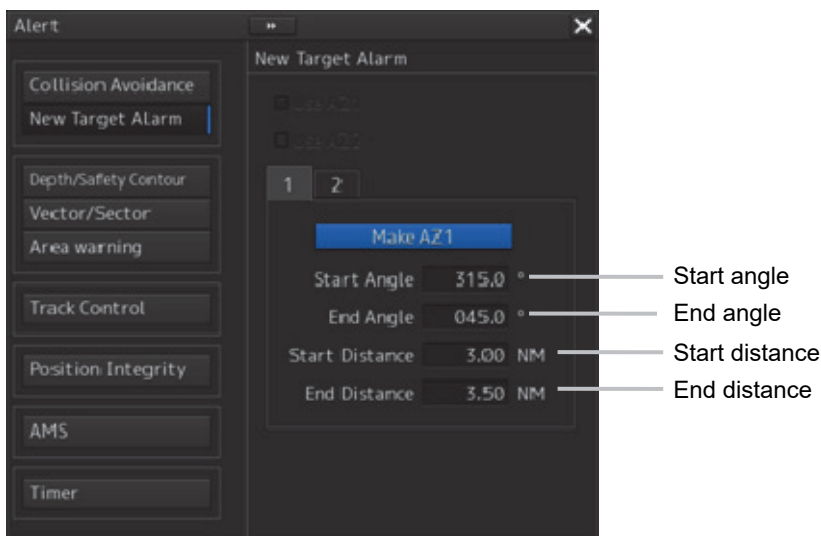

5.2.3.2 Using the cursor

- 1** Click on the [Menu] button on the left toolbar. The menu is displayed.
- 2** Click [Alert] - [New Target Alarm] on the menu. The [New Target Alarm] dialog is displayed.
- 3** Select AZ ([Use AZ1] or [Use AZ2]) to be set.

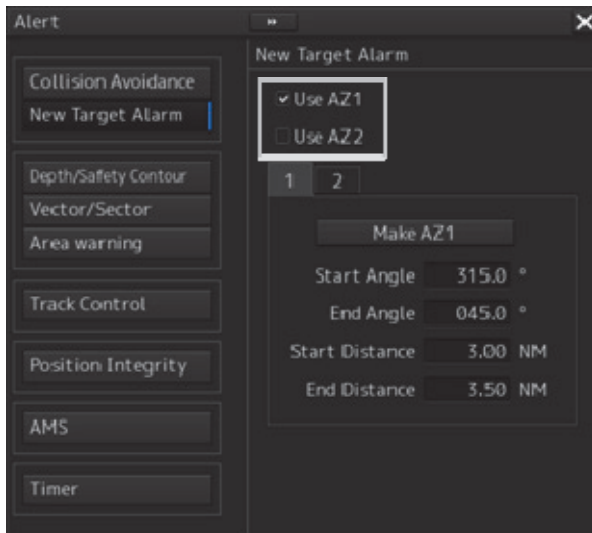

4 Click at the start angle position.

The start angle is set.

5 Move the cursor and click at the end angle position.

The line connecting the start angle and end angle appears.

6 Move the cursor and click at the start distance position.

An arc appears at the start distance position.

7 Move the cursor and click at the end distance position.

Auto acquisition/activation zone (AZ) with the shape of sector enclosed by start angle, end angle, start distance and end distance is created.

5.2.3.3 Using the EBL/VRM dial for the setting

- 1 Click on the [Menu] button on the left toolbar.
The menu is displayed.
- 2 Click [Alert] - [New Target Alarm] on the menu.
The [New Target Alarm] dialog is displayed.
- 3 Select AZ ([Use AZ1] or [Use AZ2]) to be set.

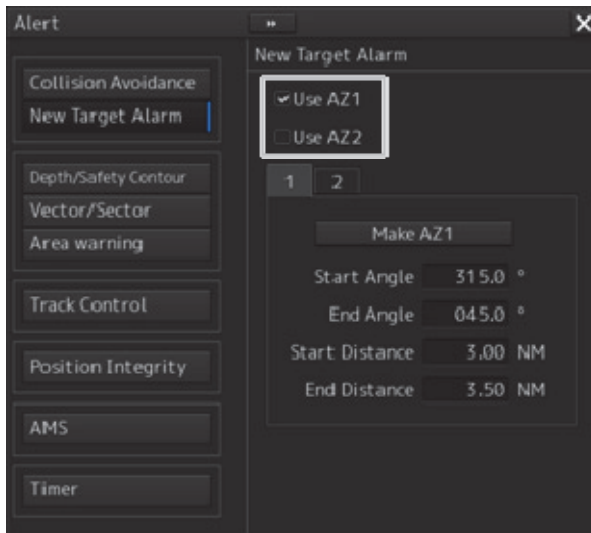

- 4 Click on the [Make AZ1] button or [Make AZ2] button.
The cursor enters the AZ creation mode.

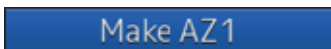

- 5 Turn the EBL dial to set [Start Angle].
- 6 Turn the VRM dial to set [Start Distance]

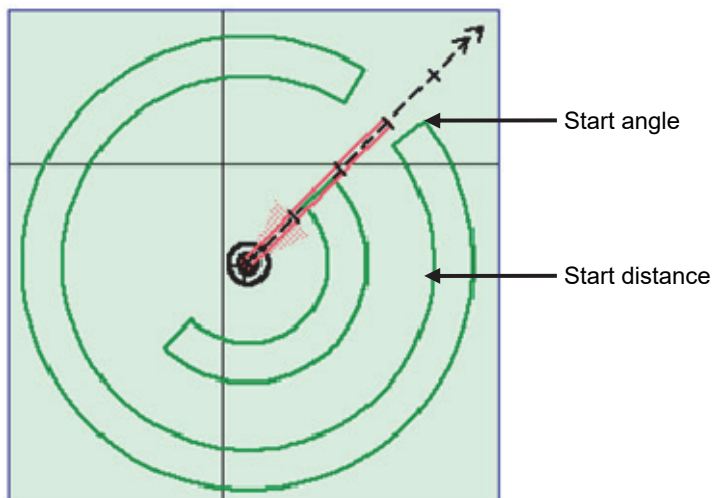

- 7 Press the EBL dial and the VRM dial.
- 8 Turn the EBL dial to set [End Angle].

9 Turn the VRM dial to set [End Distance].

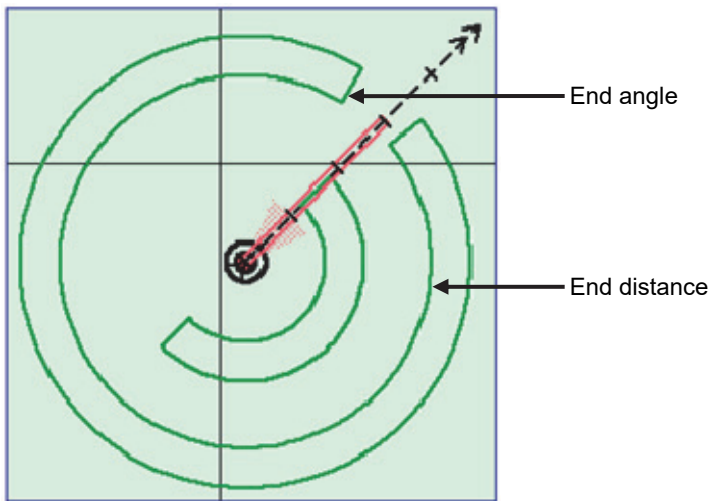

10 Press the EBL dial.

5.2.4 Tracked target information display

- 1 Set the cursor mode to the AUTO mode.
- 2 Click on the target of tracking whose numerical value is to be displayed.
 Numeric data for the specified target is displayed in the information monitoring window.

| | | | |
|-------|-------|-------|-----|
| TT ID | T1-4 | T1-36 | |
| BRG | 124.7 | 090.9 | ° |
| Range | 2.59 | 4.92 | NM |
| COG | 065.2 | 017.1 | ° |
| SOG | 57.0 | 62.9 | kn |
| CPA | 2.51 | 4.80 | NM |
| TCPA | -0.71 | -1.04 | min |
| BCR | | | NM |
| BCT | | | min |

The symbol display is changed to "⊙". The target data will remain on the radar display until the target is lost and its vector disappears, or until another target is designated.

If a target with the mark "⊙" is designated, only its true bearing and range appear until its vector appears.

Cancellation of numeric data display

- 1 Set the cursor mode to the AUTO mode.**
- 2 Place the cursor on the tracked target to cancel numeric value display and then click on.**

The numeric value disappears.

Details on tracked target information

| Item | Explanation |
|---|--|
| TT ID | ID No. of tracked target being displayed |
| BRG | True bearing |
| Range | Distance |
| CTW (Course Through the Water stabilization mode)/ COG (Course Over the Ground stabilization mode) | Course |
| STW (Speed Through the Water stabilization mode) / SOG (Speed Over the Ground stabilization mode) | Speed |
| CPA | Closest approach distance |
| TCPA | Time up to closest approach distance |
| BCR | Bow crossing distance ^{*1} |
| BCT | Bow crossing time ^{*1} |

^{*1} The BCR / BCT value of TT is not displayed on the ECDIS function.

5.2.5 Displaying Target ID No.

A target ID number is a value displayed beside the acquisition symbol when a target is acquired.

A target ID number 1 to 100 is assigned to each target in acquisition order. Once a target ID number is assigned, it identifies the target until the target is lost or the target acquisition is canceled.

Memo

The ID number is always displayed for only targets with which numeric data is displayed.

- 1 Click on the [Menu] button on the left toolbar.**
The menu is displayed.
- 2 Click on [View] - [Options] - [Target].**
The [Target] dialog is displayed.
- 3 Select the method for displaying ID No. from the [TT Target ID] list.**

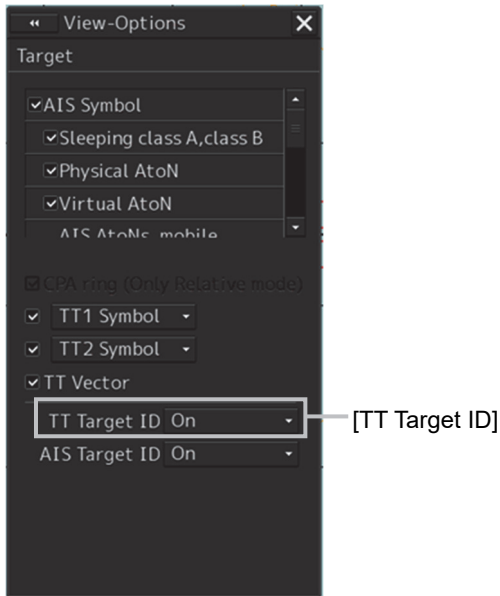

[On]: Displays target ID numbers.

[Off]: Hides target ID numbers.

[TT Track]: Displays ID numbers of only targets set for track of other ships.

[Ship's Name]: When the ship's name has been input in the [TT Target INFO] (property of tracked target) dialog box, that ship name is displayed. If the ship's name has not been input, the identification number is displayed.

Memo

If there are many tracking targets and their symbol display is confusing, set Target Number Display to off to view the radar display easily.

5.2.6 Editing tracked target properties

The properties of the individual tracked targets that were acquired can be edited freely. The [TT Target INFO] dialog is used for editing.

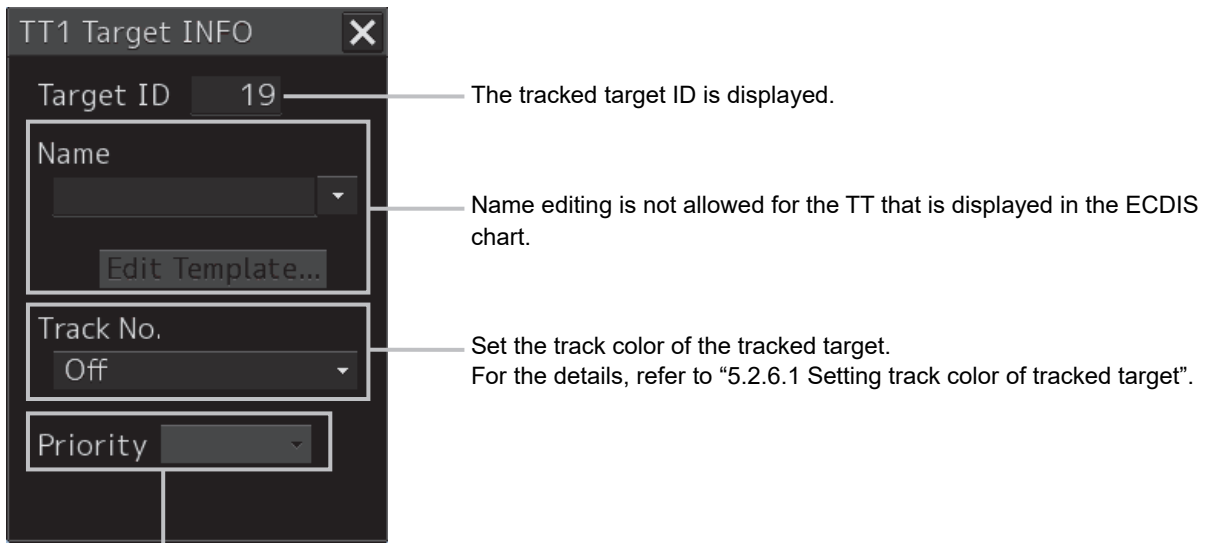

When the tracked target and the AIS target are determined to be the same, it is possible to set display priority from the tracked target and AIS target.
For the details, refer to "5.1.7 Association Target Symbols"

5.2.6.1 Setting track color of tracked target

The track color of tracked target is set.

- 1 Right-click on the cursor at the tracked target.**
- 2 Click on the [Property] on the context menu.**

The [TT Target INFO] dialog box appears.

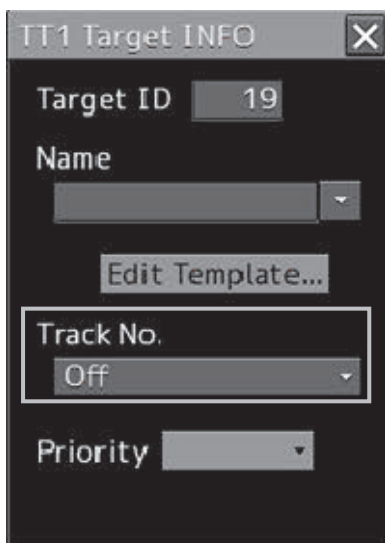

3 Select track color from the [Track Color] list.

The selection items are as follows.

Off, No.1-Color, No.2-Color, No.3-Color, No.4-Color, No.5-Color, No.6-Color, No.7-Color, No.8-Color, No.9-Color, No.10-Color, and No.11 to 20-Color

* In "Color," the track color name set by clicking [View] - [Options] - [Target Track] - [Plot] appears. For details, refer to " 14.2.9 Setting up the display of other ship's track"

5.3 Setting and Operating AIS

5.3.1 Enabling AIS Function

Note

- When the AIS function is set to Off, the AIS display function is turned off and AIS symbols are no longer displayed.
- Once AIS function is set to Off, even if a dangerous target exists, the function is not automatically switched to On.

1 Click on the [AIS] button for other ship information on the bottom left of the screen.



The button indication becomes ON and the AIS function becomes enabled.

ON indication: 

The received AIS information is displayed on the screen.

5.3.2 Activating AIS targets (Activate AIS)

Activates an AIS target, and displays the target's vector and make a collision decision.

5.3.2.1 Manual activation

Activates an AIS target in manual mode to display the vector and heading line.

- 1 Set the cursor mode to the AUTO mode.
- 2 Place the cursor on the sleeping AIS symbol to be activated and then click on.
The selected AIS target is activated.

5.3.2.2 Automatic activation

Activate an AIS target in automatic mode to display the vector and heading line.

When the automatic activation function is used, AIS targets are automatically activated when they go into the automatic activation zone. The automatic activation zone is identical to the automatic acquisition zone (AZ) used for target tracking. For the zone setting, refer to "5.2.3 Setting up the automatic activation zone (AZ)".

Note

When the AIS target's symbol is activated but the vector is not displayed, the following are probable causes of the trouble:

- COG/SOG is not input yet from the GPS.
- The selected speed sensor is malfunctioning.

Memo

The bearing or range in the acquisition/activation zone shall be based on the position of the radar antenna.

If there are more AIS targets than the allowable maximum, they are deactivated from the low-priority (Refer to "5.1 Displaying Symbols").

5.3.3 Deactivating AIS targets

Deactivates an AIS target and clear the display of the vector and heading line.

[Deactivating one AIS target]

- 1 Right-click on the AIS target to be deactivated.**
The setting items for cursor modes are displayed.
- 2 Click on the [Deactivate] on the Context menu.**
The selected AIS target is deactivated.

[Deactivating multiple AIS targets]

- 1 Right-click on the AIS target.**
The setting items for cursor modes are displayed.
- 2 Click on the [Deactivate mode] on the Context menu.**
The cursor changes to the selection cursor.
- 3 Click on the AIS target to be deactivated.**
The selected AIS target is deactivated.

Note

This operation is available only for an activated AIS target.

5.3.4 Displaying AIS information

- 1 Set the cursor mode to the AUTO mode.
- 2 Place the cursor on the AIS target to display the activated AIS target information and then click on.

The information of the selected AIS target is displayed.

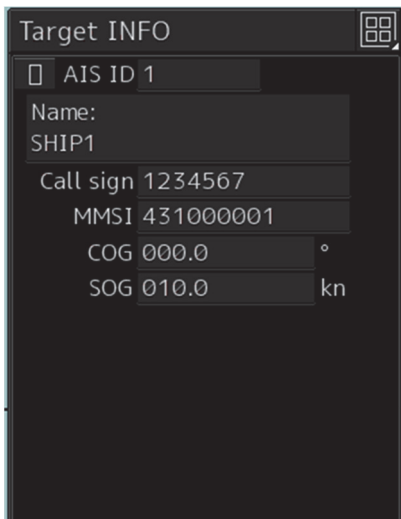

Note

When the numeric data of a target is displayed but the mark "⌈ ⌋" is not on the display, the target is outside the display.

Canceling AIS target information display

- 1 Set the cursor mode to the AUTO mode.
- 2 Move the cursor to and click on the activated AIS target whose AIS target information is to be cancelled

The information display of the selected AIS target is canceled.

Details on AIS target information

Two AIS target information display modes are available, a standard mode, and an extended mode, and the items that are displayed vary depending on the mode.

Use the AIS Standard/Extended switching button for switching between the standard mode and the extended mode.

For verifying more detailed information of the AIS target, refer to "2.3.1.4 AIS Detail INFO".

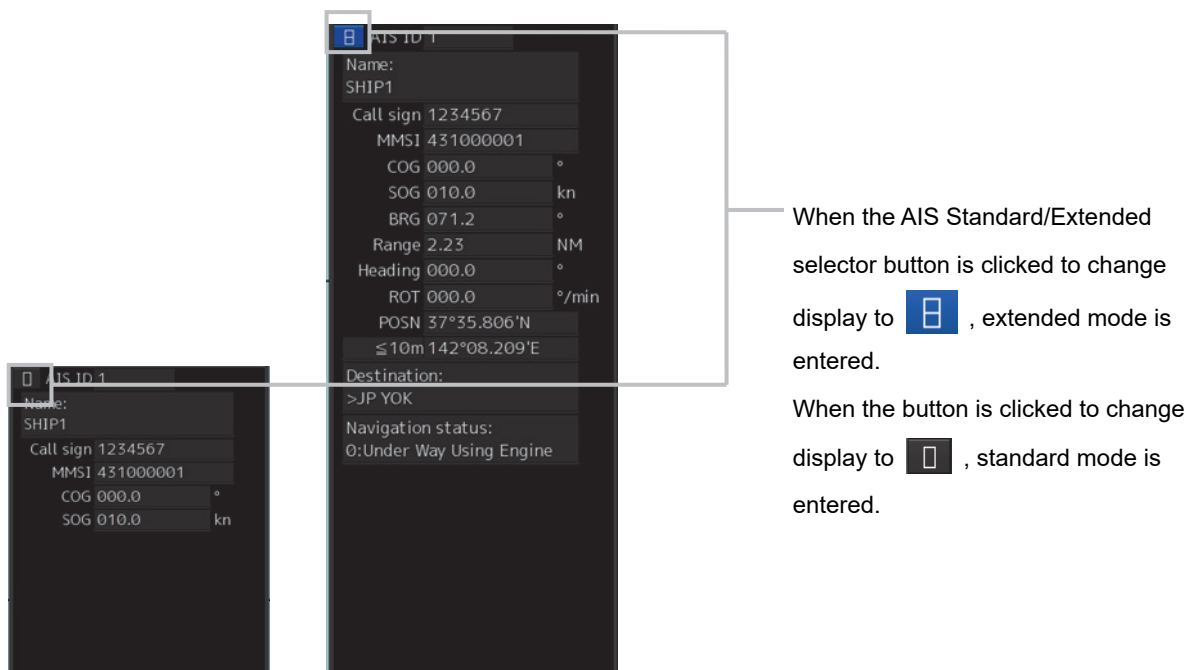

The display contents vary depending on the types of AIS targets.

[Normal AIS target]

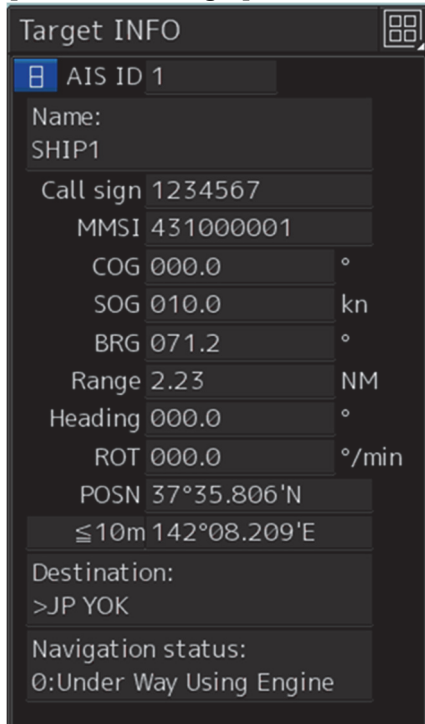

| Item | Explanation |
|-----------|---|
| AIS ID | ID No. of AIS target |
| Name | Ship name of AIS target |
| Call Sign | Call sign of AIS target |
| MMSI | Maritime Mobile Service Identity |
| COG | COG: Course Over the Ground |
| SOG | SOG: Speed Over the Ground *If the SOG column shows Over, the speed of other system is 102.2 kn or more. |
| BRG | True direction *In standard mode, this item is not displayed. |
| Range | Distance *In standard mode, this item is not displayed. |
| Heading | Heading *In standard mode, this item is not displayed. |
| ROT | Rate of turn *In standard mode, this item is not displayed. *The display range of ROT is 0.00°/min to 697.50°/min. In the case of Over, the value will be greater. In the case of ±5/30s, it indicates that ±127 is received. At this time, only turning direction indicated on the turn indicator is reliable. The turn indicator is displayed as a straight line normal to the heading direction on the AIS symbol. (Refer to "5.1 Displaying Symbols.") |

| Item | Explanation |
|--------------------|--|
| POSN | Latitude/longitude *In standard mode, this item is not displayed. |
| >10m or $\leq 10m$ | >10m: Low positioning accuracy $\leq 10m$: High positioning accuracy *In standard mode, this item is not displayed. |
| Destination | Destination *In standard mode, this item is not displayed. |
| Navigation Status | The status is displayed by number. For the details, refer to "Navigation Status" table. *In standard mode, this item is not displayed. |

Memo

In the extended mode, a display area equivalent to two standard mode areas is used.

Navigation Status

| Status |
|-------------------------------|
| 0: Under Way Using Engine |
| 1: at Anchor |
| 2: Not Under Command |
| 3: Restricted Maneuverability |
| 4: Constrained by Her Draught |
| 5: Moored |
| 6: Aground |
| 7: Engaged in Fishing |
| 8: Under Way Sailing |
| 9: Reserved for HSC |
| 10: Reserved for WIG |
| 11-14: Reserved |
| 15: Not Defined |

[AIS SARTTarget]

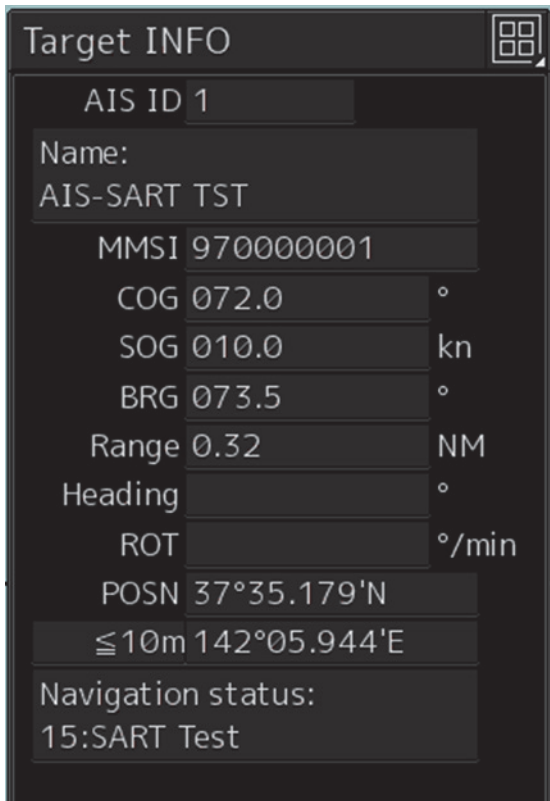

There is neither the Call Sign nor Destination item. The display of some items of Navigation Status is different. Otherwise, the display contents are the same as those of usual AIS target.

Navigation Status

| Display |
|--|
| 0 ~ 13: Same display as for the usual ship |
| AIS-SART ACTIVE(14) |
| AIS-SART TEST(15) |

Memo

Switching between standard and extended modes is not provided.

[AIS AtoN Target]

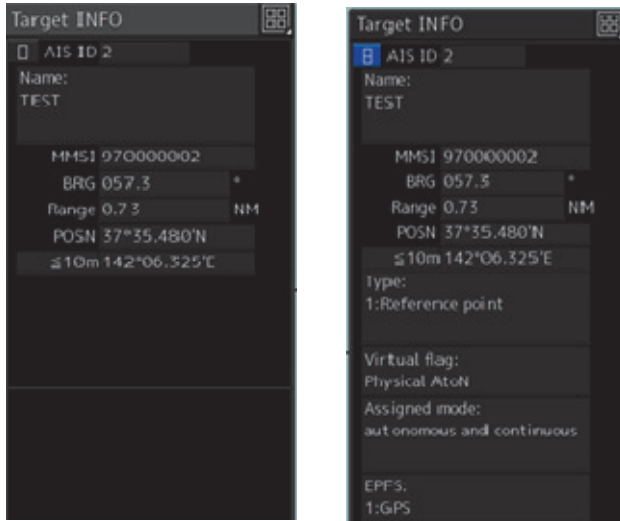

| Item | Description |
|---------------|--|
| AIS ID | AIS target ID |
| Name | Ship name of AIS target |
| MMSI | Maritime Mobile Service Identity code |
| BRG | True bearing |
| Range | Range |
| POSN | Latitude/longitude |
| >10m or ≤10m | >10m:Position fixing accuracy low ≤10m:Position fixing accuracy high |
| Type | Displays the AtoN type. For the details, refer to the “Type” table. *Not displayed in standard mode. |
| Virtual Flag | Real AtoN: Real AtoN Virtual AtoN:Virtual AtoN (does not exist) *Not displayed in standard mode. |
| Assigned Mode | Autonomous and continuous: Operating in autonomous/continuous mode Assigned: Operating in assignment mode *Not displayed in standard mode. |
| EPFS | Displays the EPFS type. For the details, refer to the “EPFS” table. *Not displayed in standard mode. |

Type

| Display |
|--|
| 0: Not Available |
| 1: Reference point |
| 2: RACON |
| 3: Fixed structure off shore |
| 4: Spare |
| 5: Light, without sectors |
| 6: Light, with sectors |
| 7: Leading Light Front |
| 8: Leading Light Rear |
| 9: Beacon, Cardinal N |
| 10: Beacon, Cardinal E |
| 11: Beacon, Cardinal S |
| 12: Beacon, Cardinal W |
| 13: Beacon, Port hand |
| 14: Beacon, Starboard hand |
| 15: Beacon, Preferred Channel Port hand |
| 16: Beacon, Preferred Channel Starboard hand |
| 17: Beacon, Isolated danger |
| 18: Beacon, Safe water |
| 19: Beacon, Special mark |
| 20: Cardinal Mark N |
| 21: Cardinal Mark E |
| 22: Cardinal Mark S |
| 23: Cardinal Mark W |
| 24: Port hand Mark |
| 25: Starboard hand Mark |
| 26: Preferred Channel Port hand |
| 27: Preferred Channel Starboard hand |
| 28: Isolated danger |
| 29: Safe Water |
| 30: Special Mark |
| 31: Light Vessel /LANBY/Rigs |

EPSF

| Display |
|-------------------------|
| 0: Undefined |
| 1: GPS |
| 2: GLONASS |
| 3: combined GPS/GLONASS |
| 4: LORAN-C |
| 5: Chayka |
| 6: INS |
| 7: surveyed |
| 8: Galileo |
| 15: internal GNSS |
| 9-14: not used |

5.3.5 Displaying Target ID No.

When an AIS target is activated, a target ID number is displayed next to the AIS target symbol. A target ID number 1 to 500 is assigned to each target in the order of targets being received by MFD. Once a target ID number is assigned, it identifies the AIS target until the AIS target is lost.

- 1 Click on the [Menu] button on the left toolbar.**
The menu is displayed.
- 2 Click on the [View] - [Options] - [Target] on the menu.**
The [Target] dialog is displayed.
- 3 Select the method for displaying ID No. from the [AIS Target ID] combo box.**

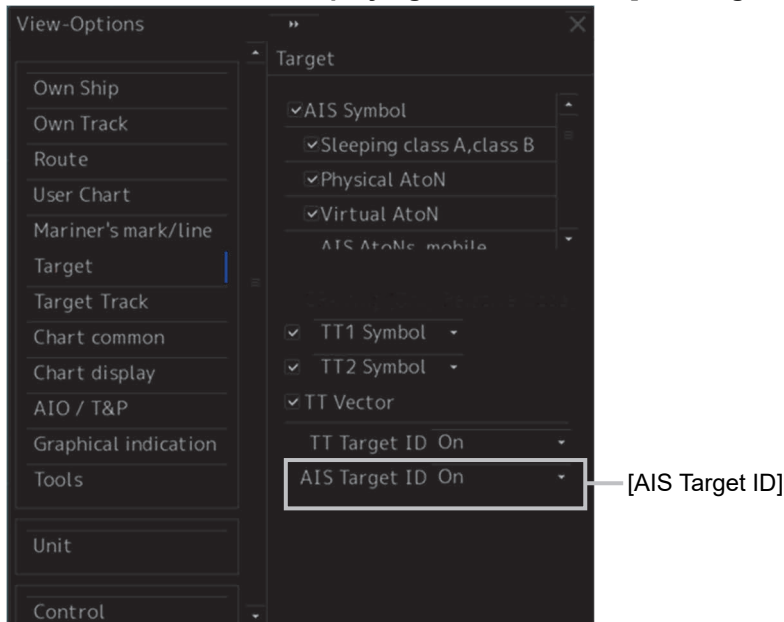

- [On] : Displays target ID numbers.
 [Off] : Hides target ID numbers.
 [AIS Track] : Displays ID numbers of only targets set for track of other ships.
 [Ship's Name] : Displays the ship's name.

Memo

- ID number or ship's name is always displayed for only targets with which numeric value is displayed.
- If there are many AIS targets and their symbol display is confusing, set Target Number Display to off to view the radar display easily.

5.3.6 Checking and Setting AIS Target Property

The AIS target property such as ID name can be checked for individual acquired AIS targets. The track color of AIS target can also be set.

The [AIS Target INFO] dialog is used for editing.

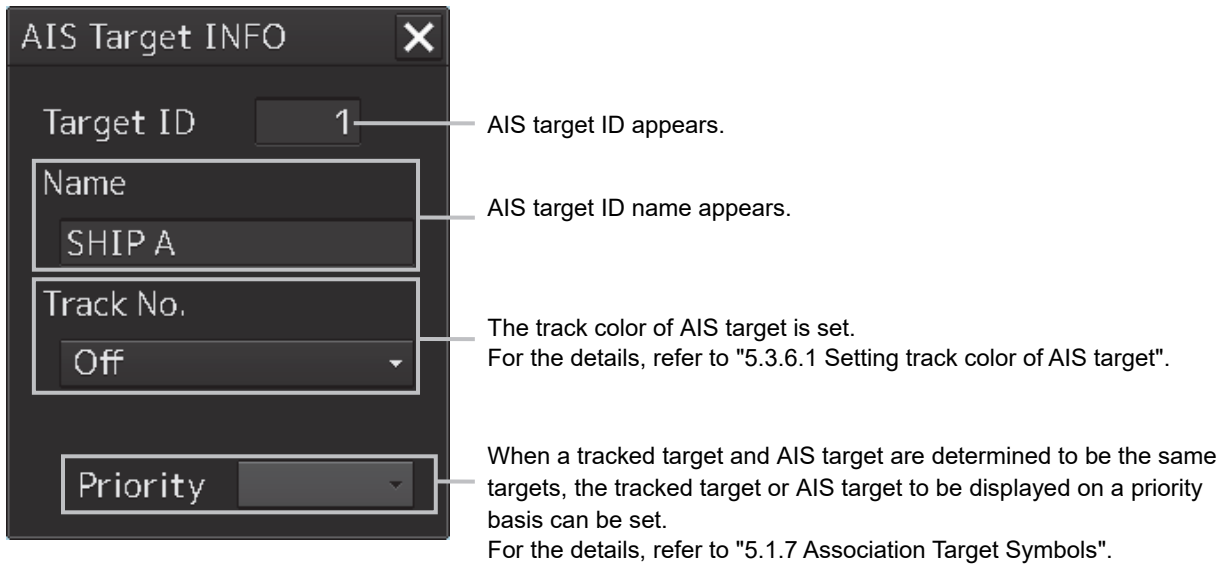

5.3.6.1 Setting track color of AIS target

The track color of AIS target is set.

- 1 Right-click on the AIS target.**
The context menu is displayed.
- 2 Click on [Property] on the context menu.**
The [AIS Target INFO] dialog box appears.

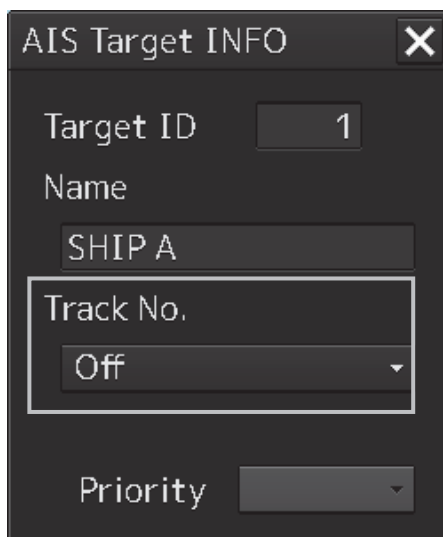

3 Select the track color from the [Track No.] combo box.

The selection items are as follows.

Off, No.1-Color, No.2-Color, No.3-Color, No.4-Color, No.5-Color, No.6-Color, No.7-Color, No.8-Color, No.9-Color, No.10-Color, No.11 to 20-Color

* In "Color," the track color name set by clicking [View] - [Options] - [Target Track] - [Plot] is displayed. For the details, refer to "14.2.8 Setting up the display of other ship's track".

5.3.7 Conditions for deciding AIS target to be lost

About an AIS target lost

When the data of a target cannot be received for a specified time, the target is decided to be lost and the target data is deleted. As shown in the table below, the time until target data is deleted varies depending on the class of received data and the target status.

Note

- Since the lost time and that of the AIS indicator are different, this equipment may display lost information earlier than the AIS display depending on the target status (speed, navigation status, etc.).

Conditions for Deciding Target to be Lost

| Target status | Time until data is lost | | |
|---|-------------------------|-----------------------------|-------------------------|
| | SOLAS ship (Class A) | Non-SOLAS ship (Class B) | |
| | | CS (Carrier Sense) | SO (Self Organizing) |
| Vessel below 3 kn (Class A) or 2 kn (Class B) and it is now at anchor or on the berth | 18 min | 18 min | |
| Vessel of 3 kn or more and it is now at anchor or on the berth | 60 sec | 18 min | |
| Vessel of 0 to 14 kn (Class B: 2 to 14 knots) | 60 sec | 180 sec | |
| Vessel of 0 to 14 kn and it is now changing the course | 60 sec | 180 sec | |
| Vessel of 14 to 23 knots | 36 sec | 180 sec | 90 sec |
| Vessel of 14 to 23 kn and it is now changing the course | 36 sec | 180 sec | 90 sec |
| Vessel of 23 kn or more | 30 sec | 180 sec | 30 sec |
| Vessel of 23 kn or more and it is now changing the course | 30 sec | 180 sec | 30 sec |
| AtoN (Aids to navigation) | 18 min | 18 min | |
| SART | 6 min | 6 min | |
| AIS-AtoN | 6 min | 6 min | |
| AIS SAR aircraft (fixed wing, helicopter) | 60 sec | 60 sec | |
| AIS coastal base station | 60 sec | 60 sec | |

Note

- When the [AIS] button in the target ship information window is turned off, the symbol is canceled.

5.4 Alert Display

Target tracking and AIS system have the following alerts.

| Message | Description |
|----------------------|--|
| AIS ACT 95% Capacity | The number of activated AIS targets reached 95% of tolerance. |
| AIS 95% Capacity | The number of AIS targets reached 95% of tolerance. |
| AIS Maximum Capacity | The number of AIS targets reached the maximum number of targets displayed. |

5

An alert is displayed in the alert notification area (upper right of the screen).

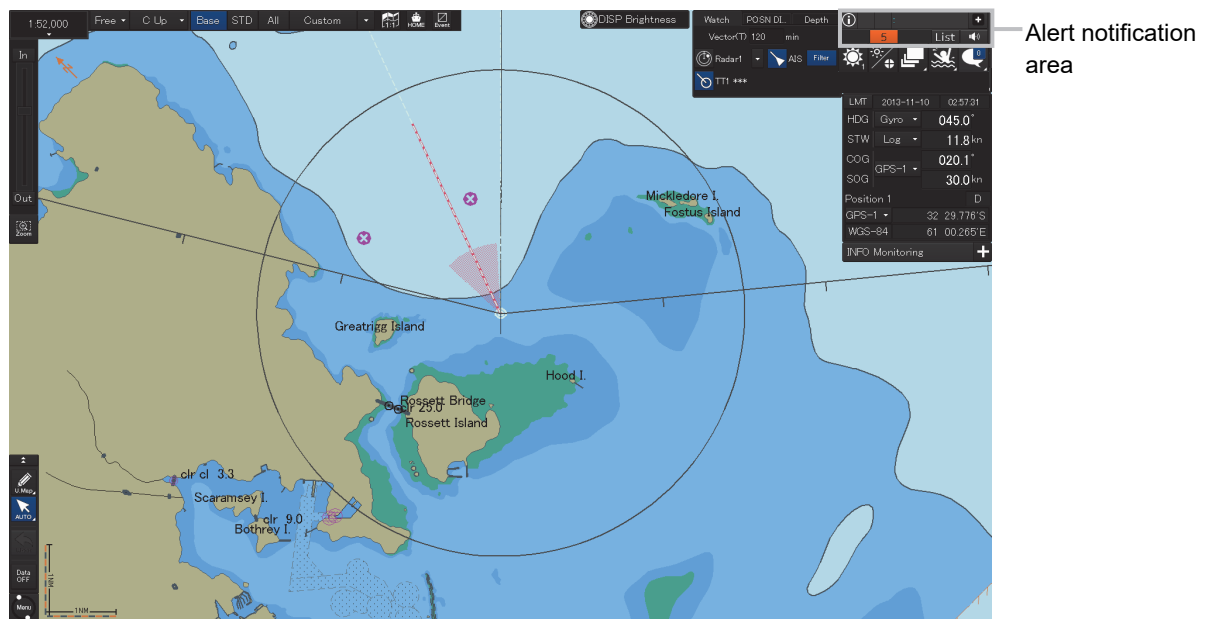

5.4.1 Gyro set notification (Set Gyro)

The GYRO I/F in this system receives signals from a gyro. Even if the power is turned off, the system will follow up the gyro. However, the system stops the follow-up operation when the power of the master gyro is turned off or when any trouble occurs to the line. When the power of the master gyro is recovered, the [Set Gyro] notification will be issued.

When this notification is issued, set the true bearing value of the gyro. For the details, refer to "6.14 True bearing".

Gyro Set Notification

| Alert characters | Alarm sound | Conditions |
|------------------|------------------|---|
| Set Gyro | Beep sound (pi-) | The signals from the gyro are stopped, but the gyro is recovered. |

5.5 Setting the Display of Other Ship's Track

This section describes the setting of the tracked target and the tracks of AIS target. This equipment can display the tracks of up to 20 target ships.

5.5.1.1 Setting track color

For details on how to set the track color of tracked target, refer to "5.2.6.1 Setting track color of tracked target"

For details on how to set the track color of AIS target, refer to "5.3.6.1 Setting track color of AIS target"

5.5.1.2 Turning on/off other ship's track function

For the details, refer to "16.7 Setting up Other Ship's Track Function To ON/OFF".

Note

Note that when this function is turned off, all the other ship's track functions are turned off. In this case, the track data of other ships is not saved, so they cannot be traced later.

5.5.1.3 Setting other ship's track colors

You can set either one track color for all targets under tracking, or individual colors for the ships of track numbers from 1st to 10th. The same color is used to display the 11th to 20th ships.

For the details, refer to "14.2.9 Setting up the display of other ship's track".

Note

If the other ship's track function (Target Track Function) is turned off, the track data of other ships is not saved.

5.5.1.4 Turning on/off other ship's track display

The target track display function can be turned on/off. Choices for track display are displaying/hiding the tracks of all ships and Individual (displaying the tracks of individual ships).

For the details, refer to "14.2.9 Setting up the display of other ship's track".

Note

Even when Target Track Display is turned off, the track data of other ships is saved if Track Display Interval is set.

5.5.1.5 Setting up a display interval of other ship's track

A display interval of other ship's track can be set.

For the details, refer to "14.2.9 Setting up the display of other ship's track".

Note

This function is not available when the Target Track Function is turned off.

5.5.1.6 Clearing other ship's track

The other ship's track can be cleared by setting a color or a track number.

For the details, refer to "14.2.9 Setting up the display of other ship's track".

5.5.1.7 Saving and loading other ship's track data

Other ship's track data can be saved on HDD and load from the HDD.

(Data can be saved to HDD until the data volume becomes full.)

For the details, refer to "3.21.2 File management".

5.6 Entering Own Ship's AIS Voyage Data

Set the own ship's AIS voyage data.

- 1 Click on the [Menu] button on the left toolbar.

The menu is displayed.

- 2 Click on [TT/AIS] - [AIS Voyage Data] on the menu.

The [AIS Voyage Data] dialog box appears.

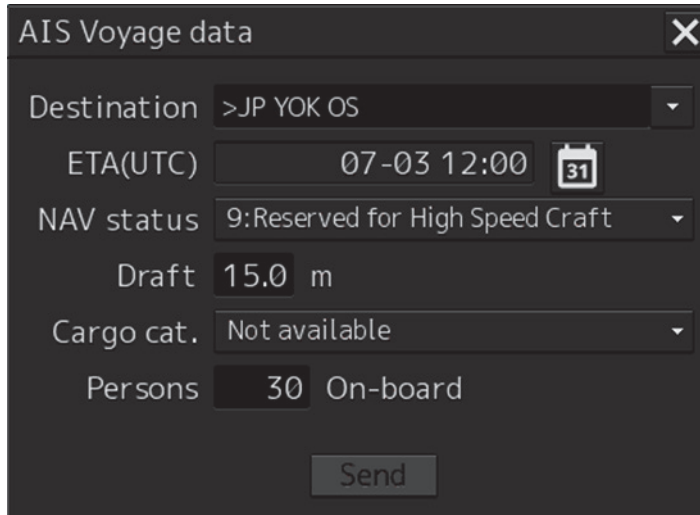

In the [AIS Voyage Data] dialog box, information collected from AIS is displayed.

- 3 Enter information manually if not being displayed, or change the information being displayed.

| Item | Setting |
|-------------------------|---|
| Destination | Enter the destination in the [Destination] input box (maximum 20 characters), or display the history list and click on the destination to enter. |
| ETA (UTC) | Click on the calendar icon  to display the date picker, and enter the expected date (and time) of arrival by clicking. |
| NAV Status | Select the "Navigation Status" from the combo box. For the details of Navigation Status, refer to "5.3.4 Displaying AIS information". |
| Draft | Enter the draft in the [Draft] input box in the range between 0 and 25.5 m. The draft can be entered in increments of 0.1 m. If the draft is more than 25.5 m, enter 25.5 m. |
| Cargo Cat. | Select the cargo category from the combo box. |
| Persons On-board | Enter the number of persons on board in the [Persons on-board] input box in the range between 0 and 8191. If the number of persons on board is more than 8191 persons, enter 8191. |

- 4 Click on the [Send] button to save the input information.

5.7 Editing and Sending AIS Messages

AIS messages can be edited and sent.

- 1 Click on the [Menu] button on the left toolbar.**

The menu is displayed.

- 2 Click on [TT/AIS] - [Edit and Send AIS Message] on the menu.**

The [Edit and Send AIS Message] dialog box appears.

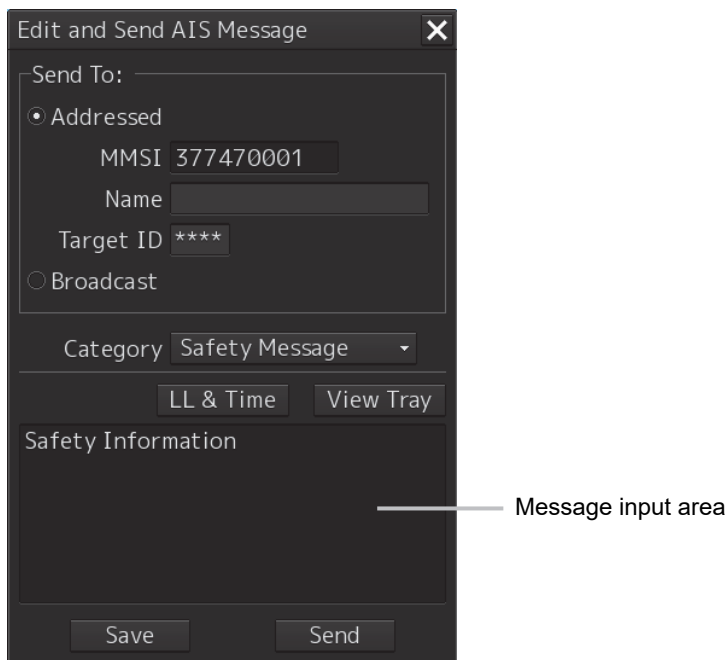

- 3 Specify whether a message will be sent by specifying an MMSI code or distributing a broadcast message.**

For the details, refer to "To send a message by specifying an MMSI code:" and "To distribute a broadcast message:".

- 4 Display the [Message Category] list and select the type of the message to send.**

To send a safety related message: Click on [Safety Message].

To send a routine message: Click on [Routine Message].

- 5 Type a message in the message input area.**

To automatically enter own ship's latitude/longitude/UTC:

Click on the [LL&Time] (latitude/longitude/time) button.

To copy an existing message:

Click on the [View Tray] button to display the contents of the AIS Message Tray. Select the message to copy to display it, and then copy it. The message can be copied from the beginning up to the maximum number of characters.

Memo

The maximum number of characters that can be input changes depending on the transmission method and the message type.

- Sending a message by specifying the MMSI code
 - Safety message: Up to 156 characters
 - Routine message: Up to 151 characters
- Distributing a broadcast message
 - Safety message: Up to 161 characters
 - Routine message: Up to 156 characters

6 Click on the [Send] button to send the message.

The message transmission confirmation dialog box appears.

When sending a message by specifying an MMSI code:

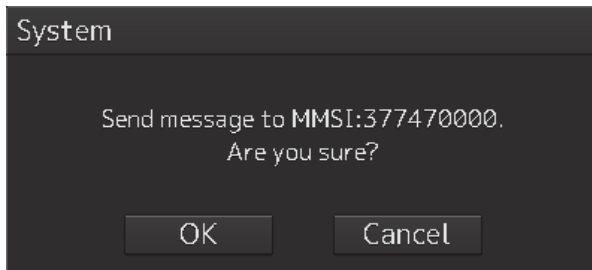

When distributing a broadcast message:

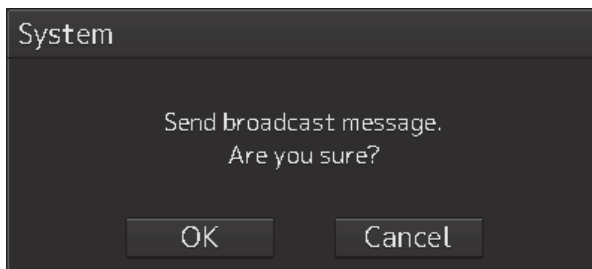
**7 Click on the [OK] button to send the message.**

To cancel the transmission of the message, click on the [Cancel] button.

The following dialog box appears while sending a message.

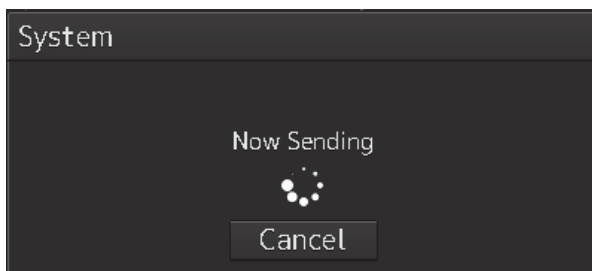

The transmission of the message currently in progress can be stopped by clicking the [Cancel] button.

The following dialog box appears when the transmission of a message completes.

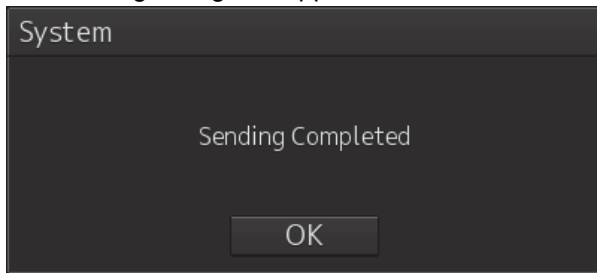

- 8** Click on the [OK] button to close the dialog box.
- 9** To save an MMSI code and a typed message in the case of MMSI transmission, click on the [Save] button.
- 10** Click on the [x] button to close the dialog box.

To send a message by specifying an MMSI code:

- 1** Click on the [Addressed MMSI] (specified MMSI code) button.
- 2** Type an MMSI code (9 digits) in the [MMSI] input box.
The name of the ship having the entered MMSI code is displayed in the [Name] box.
The identification number is displayed in the [Target ID] box.
- 3** Type a message in the message input area.
In the case of a safety related message: Maximum 156 characters
In the case of a routine message: Maximum 151 characters

To distribute a broadcast message:

- 1** Click on the [Broadcast] button.
- 2** Type a message in the message input area.
In the case of a safety related message: Maximum 161 characters
In the case of a routine message: Maximum 156 characters

5.8 AIS Message Tray

The received, sent and saved AIS messages are displayed in AIS Message Tray in a list form.

Memo

The information reference window such as AIS message tray can be switched to standard window display or extended window display.

In this example, extended window display is used.

For the details of switching between standard window display and extended window display, refer to "2.3.2.1 Switching between a standard window and an extended window".

5.8.1 Displaying the AIS message tray

- 1 Click on the [Menu] button on the left toolbar.**
The menu is displayed.
- 2 Click on [TT/AIS] - [AIS Message Tray] on the menu.**
The "Information Reference" window appears.
- 3 Click on the [AIS MSG Tray] (AIS message tray) button.**
The AIS Message Tray is displayed.

Memo

The AIS message tray can also be displayed by clicking on the [View Tray] button in the [Edit and Send AIS Message] dialog.

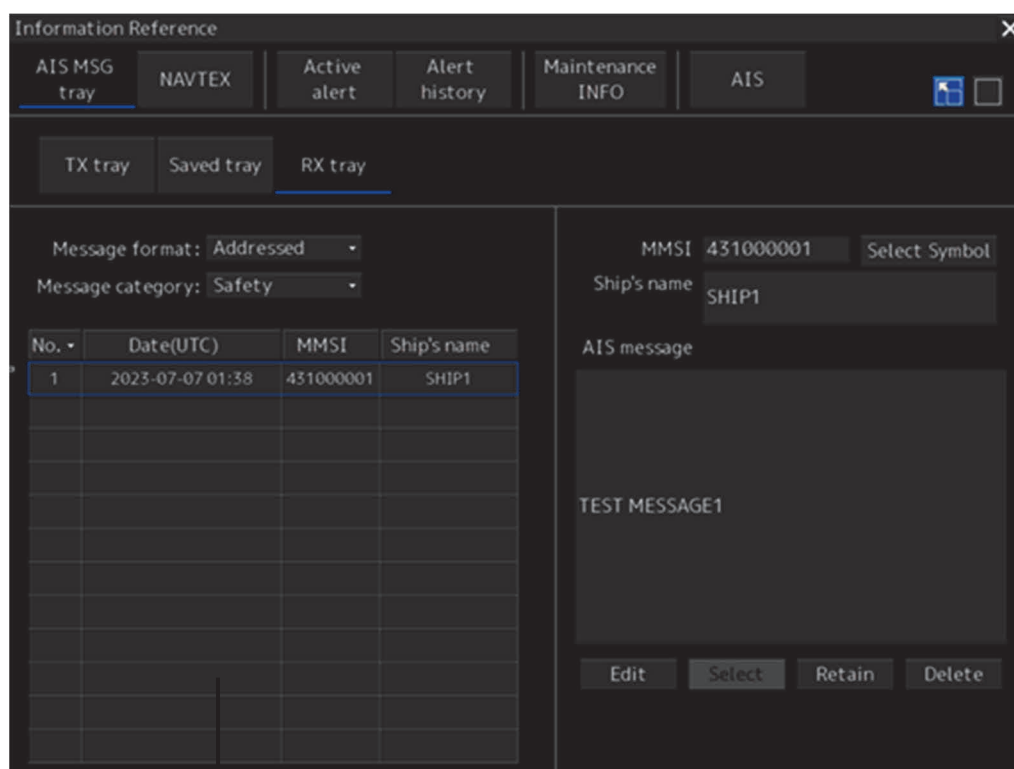

Message list

Up to 50 most recent messages are displayed in the message list, from the newest date first. When the 51st message is registered, the message having the oldest date will automatically be deleted.

By clicking any item of the title columns, messages can be sorted in ascending or descending order.

When a message is clicked in the message list, the detailed information of that message will be displayed in the right area of the list.

5.8.2 Switching message display

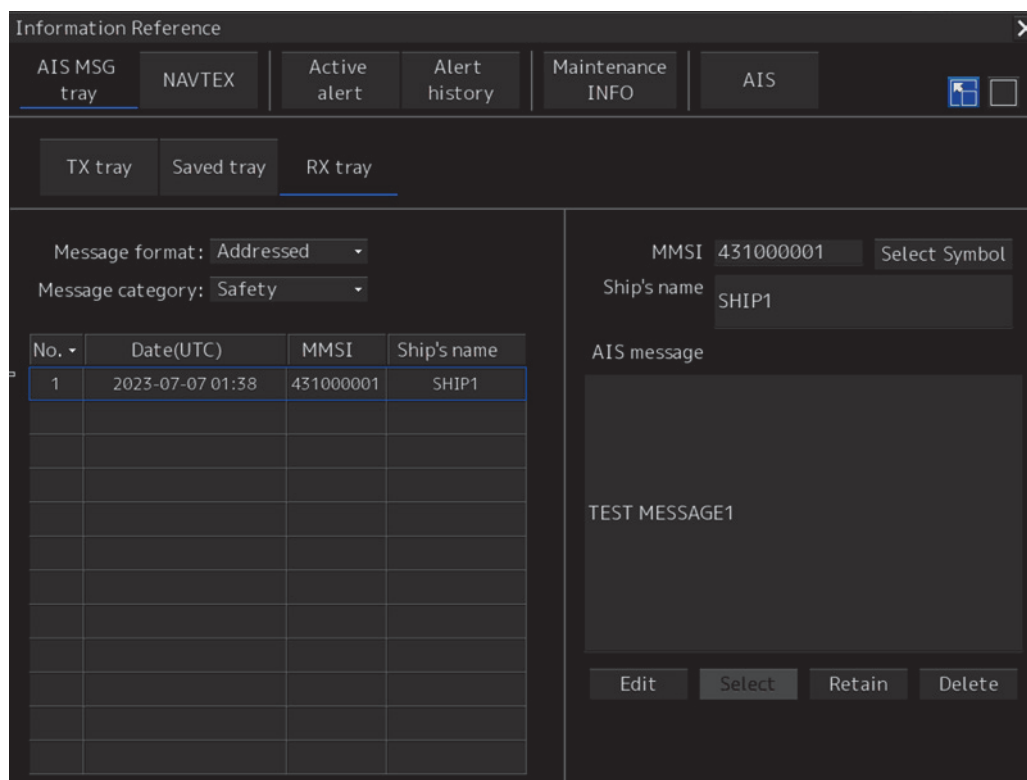

To display transmitted messages:

Click on the [TX Tray] (Transmitted Tray) button.

To display saved messages:

Click on the [Saved Tray] button.

To display received messages:

Click on the [RX Tray] (Received Tray) button.

Unread messages are displayed in boldface.

To filter messages by specifying the transmission method:

To display only messages sent/received by specifying an MMSI code:

Click on the [Addressed] (address specification) button.

To display only messages distributed through broadcasting:

Click on the [Broadcast] button.

When messages are not filtered by the transmission method:

Click on the [All] (display all) button.

How to select the target by searching with MMSI from the displayed AIS symbol method:

Click on the [Select Symbol] button.

If the capacity is exceeded the following rules will be to organize the message.

| Message Type | | Max | Message Organizing Rules. |
|---|----|---|---------------------------|
| Safety Related Address specification | 20 | | |
| Safety Related Broadcast | 20 | (For each AIS type) Delete the oldest message. | |
| Safety Related (Retained) | 20 | (For each AIS type) Delete the oldest message from retained and move It to address or broadcast. If it is exceeded at that time, delete the oldest message. | |
| Routine Message | 50 | (For routine message) Delete the oldest message. | |

To filter messages by specifying category:

To display only safety related messages:

Click on the [Safety] (safety related) button.

To display only routine messages:

Click on the [Routine] button.

When messages are not filtered by category:

Click on the [All] (display all) button.

5.8.3 Sending a message in the message tray after editing

1 Click the message to copy in the message list.

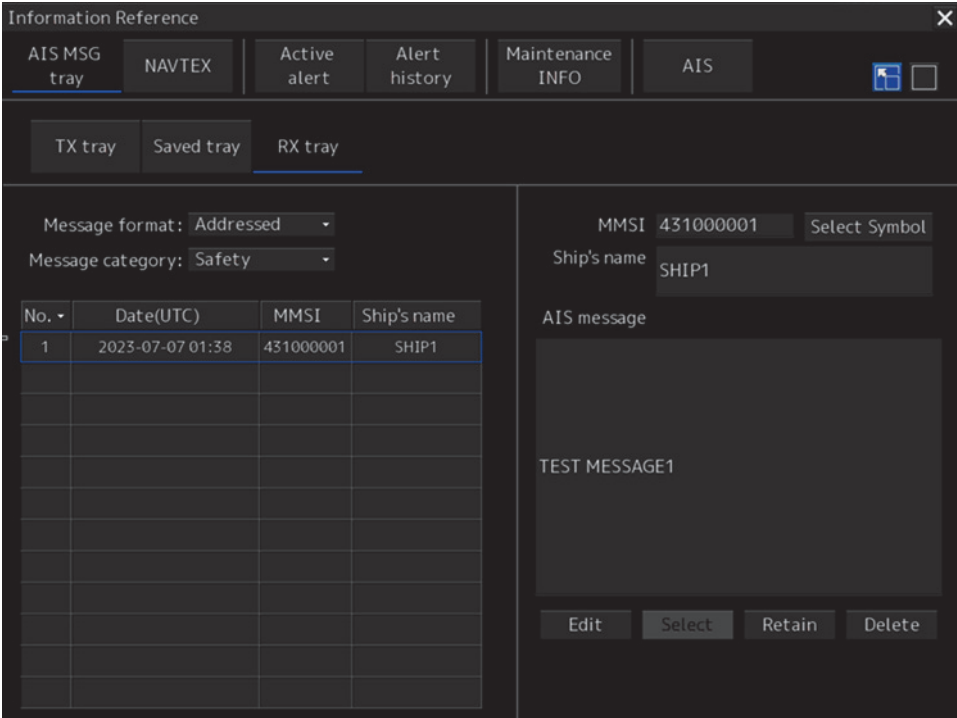

2 Click on the [Edit] or [Select] button.

When the AIS Message Tray is displayed by opening the AIS Message Tray submenu: Click the [Edit] button.

The [Edit and Send AIS Message] dialog box appears, and the AIS message will be copied to the [Edit and Send AIS Message] dialog box. When a message is sent by specifying an MMSI code, the MMSI code will also be copied:

When the AIS Message Tray was displayed by clicking the [View Tray] button in the [Edit and Send AIS Message] dialog box: Click the [Select] button.

The AIS message will be copied to the [Edit and Send AIS Message] dialog box. The MMSI code is not copied by this method.

5.9 Highlighting TT/AIS Symbols

TT/AIS symbols can be searched by specifying criteria and highlight them.

- 1 Click on the [Menu] button on the left toolbar.

The menu is displayed.

- 2 Click on [TT/AIS] - [Highlighting] on the menu.

The [Highlighting] dialog box appears.

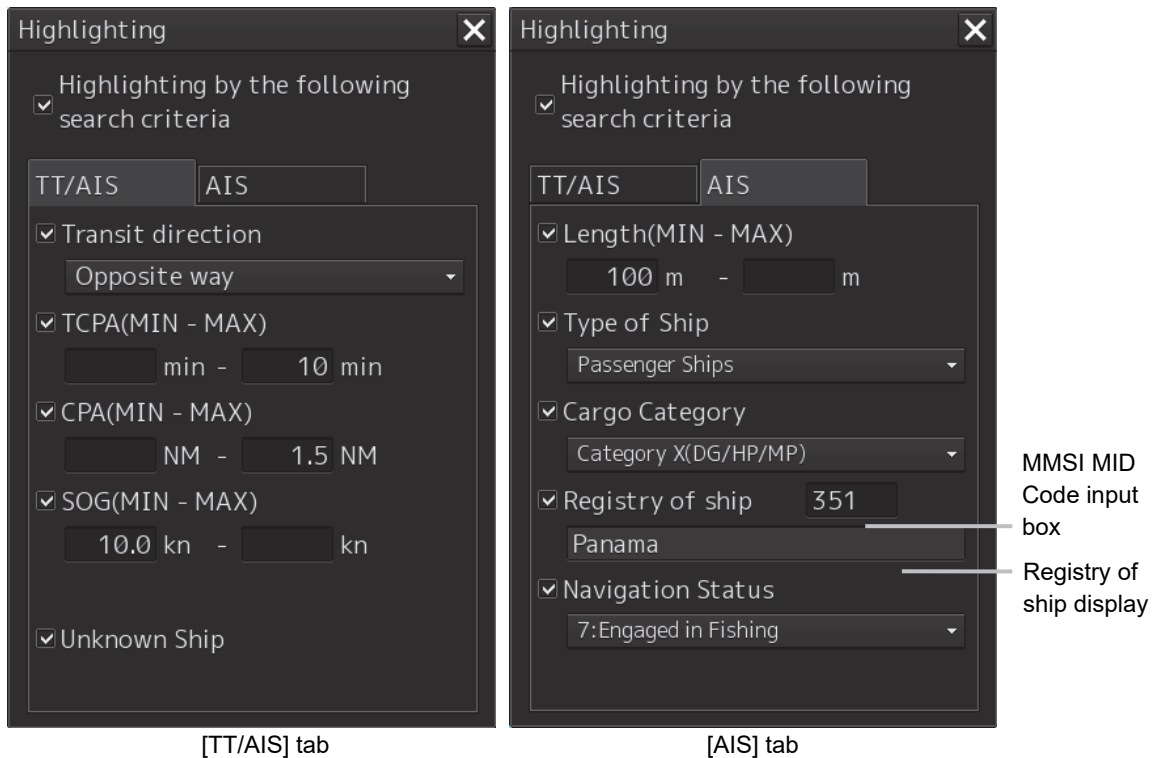

- 3 To include all search criterions as highlight targets, select the [Highlighting by the following search criteria] checkbox.

To exclude all search criterions from highlight targets, clear the [Highlighting by the following search criteria] checkbox.

- 4 If the [Highlighting by the following search criteria] checkbox is selected in step 3 above, clear the checkboxes of the search criterion to be excluded from highlighting.

5 Of the checked search items, specify the search criteria for highlighting.

[Transit direction]: Select the transit direction from the combo box.

| | |
|--------------|--------------------|
| N | Sailing North |
| NE | Sailing North East |
| E | Sailing East |
| SE | Sailing South East |
| S | Sailing South |
| SW | Sailing South West |
| W | Sailing West |
| NW | Sailing North West |
| Same way | Same way |
| Opposite way | Opposite way |

| Item | Setting |
|-------------------|--|
| TCPA | Specify the minimum and maximum values in the range between 1 to 99 min. |
| CPA | Specify the minimum and maximum values in the range between 0.1 to 9.9 NM. |
| SOG | Specify the minimum and maximum values in the range between 0.0 to 102.2 kn. |
| Unknown Ship | As a result of conducting association processing using the TT/AIS function, targets that were not identified will be categorized as unknown ships. |
| Length | Specify the minimum and maximum values in the range between 1.0 to 1022.0 m. |
| Type of ship | Open the list and click on the type of the ship to be highlighted. |
| Cargo category | Open the list and click on the cargo category to be highlighted. |
| Registry of ship | Specify the MMSI MID Code in the range between 200 and 800. The registry of ship corresponding to the entered code is displayed. |
| Navigation Status | Open the list and select the navigation status to be highlighted. |

5.10 Displaying the TT/AIS Target List

The information of targets being monitored with the TT and AIS functions can be displayed in a list on the information monitoring window.

5.10.1 Displaying TT/AIS List

Take the following steps to display the TT list and AIS list.

1 Click on the [Menu] button on the left toolbar.

The menu is displayed.

2 Click on [TT/AIS] - [TT/AIS List] on the menu.

The "TT/AIS" list is displayed in the information monitoring window.

- [TT1 List] and [TT2 List] buttons are displayed. Clicking on these buttons display TT1 and TT2 information.
- Clicking on the [AIS List] button displays AIS information.

When [BRG/RNG] is clicked, the Bearing and Range of the target from the own ship are displayed as the other ship's position in the row of the list.
When [Lat/Lon] is clicked, Lat and Lon (latitude/longitude) is displayed as the other ship's position in the row of the list.

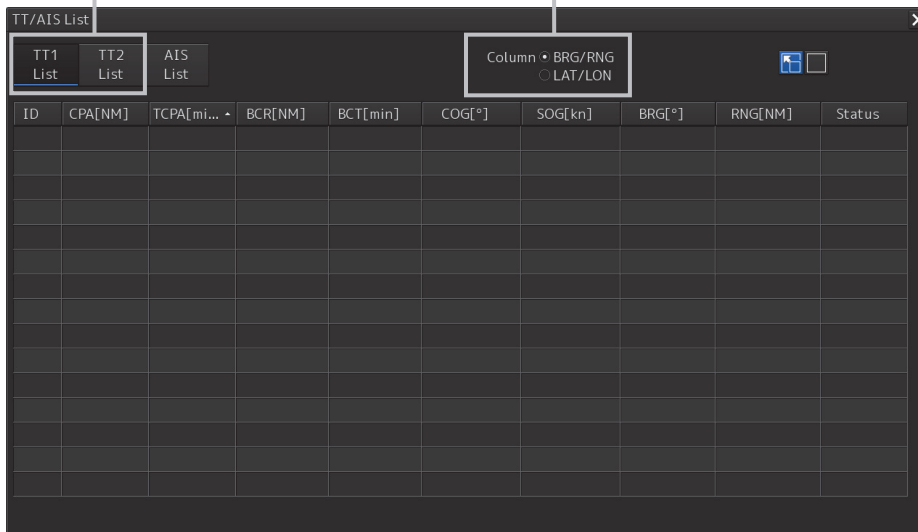

5.10.1.1 Switching between a standard window and an extended window

The TT/AIS list can be switched to a standard window or an extended window.

To switch to an extended window, click on the List extension button.

To switch to a standard window, click on the List Standard button.



[Example of Extended window]

| ID | BRG[°] | RNG[NM] | HDG[°] | LAT | LON | Status |
|----|--------|---------|--------|-------------|--------------|----------|
| 1 | 019.7 | 20.18 | 220.0 | 35°02.604'N | 136°51.644'E | Sleeping |
| 4 | 008.6 | 15.85 | 225.0 | 34°59.269'N | 136°46.264'E | Sleeping |
| 3 | 009.4 | 16.16 | 270.0 | 34°59.543'N | 136°46.615'E | Sleeping |
| 2 | 012.9 | 13.68 | 045.0 | 34°56.930'N | 136°47.107'E | Sleeping |
| | | | | | | |
| | | | | | | |
| | | | | | | |
| | | | | | | |
| | | | | | | |
| | | | | | | |
| | | | | | | |
| | | | | | | |
| | | | | | | |
| | | | | | | |
| | | | | | | |

[Example of standard window]

The screenshot shows a window titled "AIS List" with a table of AIS data. The table has three columns: ID, COG[°], and SOG[kn]. The data rows are as follows:

| ID | COG[°] | SOG[kn] |
|----|--------|---------|
| 1 | 220.0 | 1.0 |
| 4 | 225.0 | 1.0 |
| 3 | 270.0 | 1.0 |
| 2 | 045.0 | 1.0 |
| | | |
| | | |
| | | |
| | | |
| | | |
| | | |
| | | |
| | | |

A scroll bar is located at the bottom of the table area, with an arrow pointing to it from the label "Scroll bar" below.

Scroll bar

By dragging the scroll bar, the overlapped section can be displayed.

Memo

A standard window is displayed at the initial display.

5.10.2 TT List

The screenshot shows a software window titled "TT/AIS List" with a close button in the top right corner. Below the title bar are three tabs: "TT1 List", "TT2 List", and "AIS List". To the right of the tabs is a "Column" menu with two options: "BRG/RNG" (selected) and "LAT/LON". The main area of the window is a table with the following columns: ID, CPA[NM], TCPA[mi...], BCR[NM], BCT[min], COG[°], SOG[kn], BRG[°], RNG[NM], and Status. The table is currently empty.

Display Example

| Item | Description |
|--------|--|
| ID | ID No. of tracked target |
| CPA | Closest approach distance |
| TCPA | Time up to closest approach distance |
| BCR | Bow crossing distance |
| BCT | Bow crossing time |
| COG | COG: Course Over the Ground |
| SOG | SOG: Speed Over the Ground |
| BRG | True direction |
| RNG | Distance |
| Lat | Latitude |
| Lon | Longitude |
| Status | Status Initial ACQ: Initial acquisition in progress Tracking: Acquisition in progress Lost: Lost status Danger: Dangerous ship |

Memo

When the TT list is displayed initially, the items are sorted in the order of TCPA. When the sequence is changed, the items are displayed in the last sort sequence.

5.10.3 AIS List

When [CTW/STW/Name/Call Sign/MMSI/Source] is clicked, CTW, STW, Name, Call Sign, MMSI, and Source are displayed in the rows of list.

When [BCR/BCT/BRG/RNG/HDG/POSN/Status] is clicked, BCR, BCT, Bearing, Range, Heading, Lat, Lon, and Status are displayed in the row of list.

| ID | COG[°] | SOG[kn] | Name | Call Sign | MMSI | Source |
|----|--------|---------|--------------------|-----------|-----------|--------|
| 1 | 220.0 | 1.0 | SHIPNAME-377470000 | JRC0001 | 377470000 | Direct |
| 4 | 225.0 | 1.0 | SHIPNAME-377470003 | JRC0004 | 377470003 | Direct |
| 3 | 270.0 | 1.0 | SHIPNAME-377470002 | JRC0003 | 377470002 | Direct |
| 2 | 045.0 | 1.0 | SHIPNAME-377470001 | JRC0002 | 377470001 | Direct |

Display Example
Example of Vector
Length

| Item | Description |
|-----------|---|
| ID | ID No. of AIS |
| COG | COG: Course Over the Ground |
| SOG | SOG: Speed Over the Ground |
| Name | Ship name |
| Call Sign | Call sign |
| MMSI | Maritime Mobile Service Identity |
| Source | AIS information source - Direct - Repeated - VTS |
| BCR | Bow crossing distance |
| BCT | Bow crossing time |
| BRG | True direction |
| RNG | Distance |
| HDG | Heading |
| Lat | Latitude |

| Item | Description |
|--------------------------|---|
| Lon | Longitude |
| Status | Status Sleeping: Sleeping in progress Activated: Activation in progress Lost: Lost status Danger: Dangerous ship |
| [Show AIS Detail] button | When one item is selected from the list and this button is clicked, AIS detail information is displayed in the information monitoring window. For the details, refer to "2.3.1.4 AIS Detail INFO". |

5.11 Confirming Own Ship's AIS Information

Take the following steps to display own ship's AIS information.

- 1 Click on the [Menu] button on the left toolbar.**
The menu is displayed.
- 2 Click on [TT/AIS] - [Own Ship AIS Data] on the menu.**
The "Information Reference" (information monitoring window) is displayed.
- 3 Click on the [Own Ship AIS Data] button.**
Own ship's AIS information is displayed in the information monitoring window.

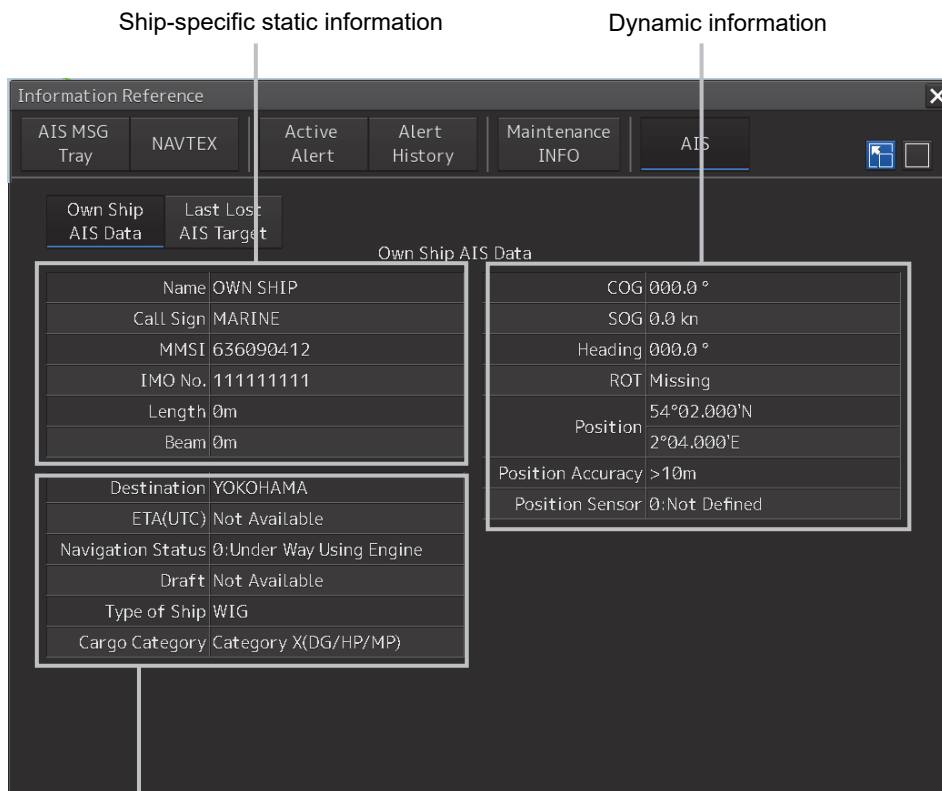

Static information that may change during each navigation

Memo

The Information Reference can be switched to standard window display or extended window display.

In the above example, the extended window is used.

For the details of switching between the standard window and the extended window, refer to "2.3.2.1 Switching between a standard window and an extended window".

5.12 Display of AIS-SART

AIS-SART is a device to display data relating to the position of the ship in distress on the AIS display unit of the ship station and coast radio station which install the AIS.

When connecting this device with the AIS, AIS-SART symbols can be also displayed on the screen.

5.12.1 Radar screen display example

If receiving AIS-SART signals from its device, an AIS-SART symbol is displayed on the radar screen.

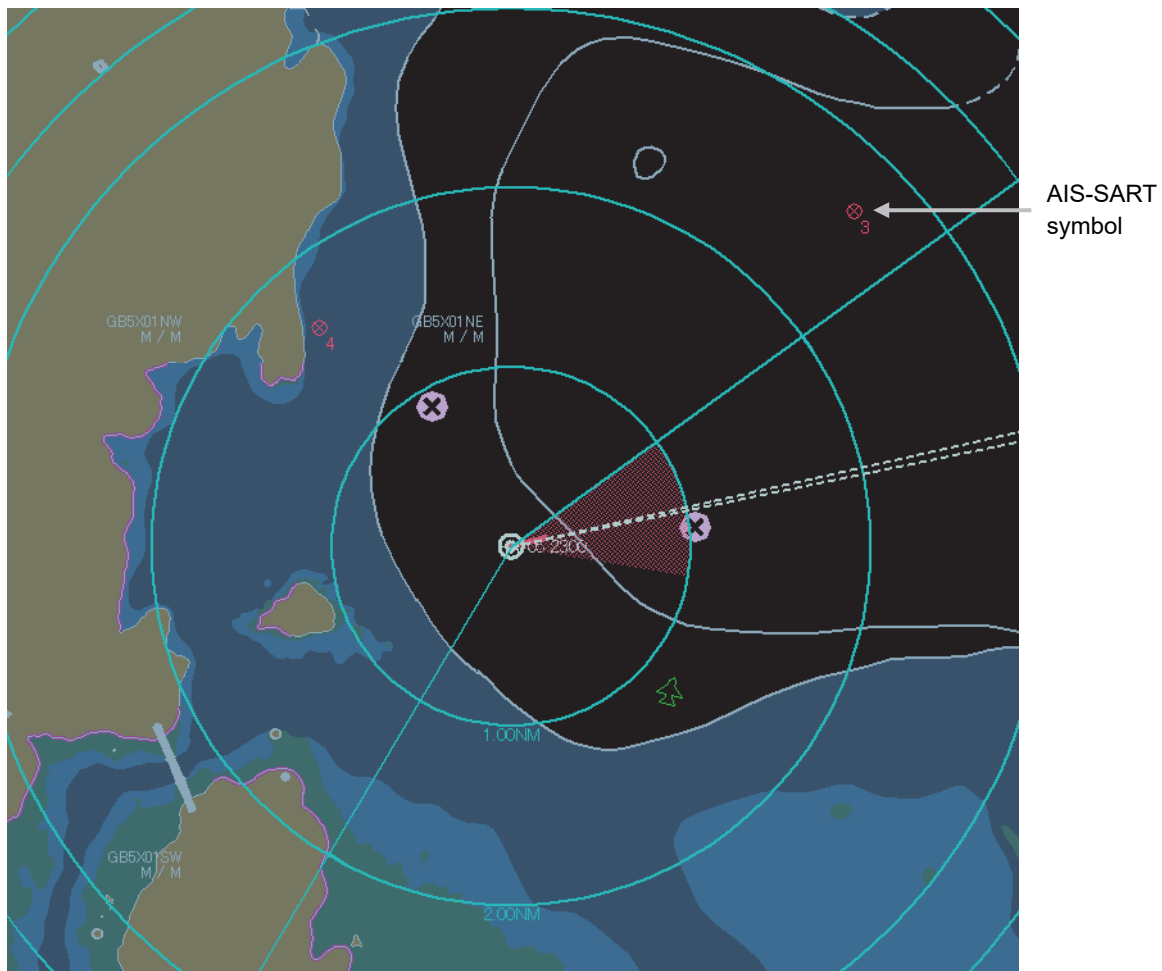

Example of AIS-SART Symbol Display

*For the details of AIS-SART symbols, refer to "5.1.3 Types and Definitions of AIS Target Symbols".

5.12.2 Numeric data display example

When the AIS-SART symbol is clicked on while it is displayed, AIS-SART numeric data is displayed in the Target Info on the information monitoring window.

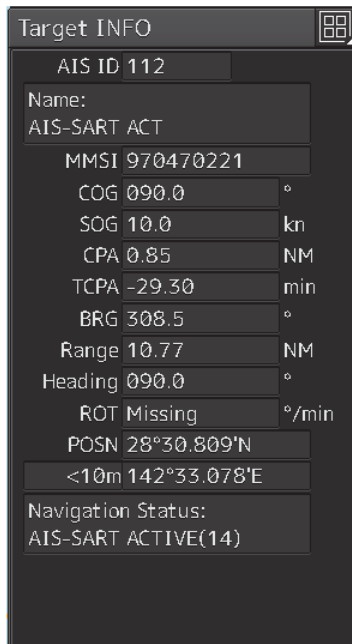

Example of AIS-SART Numeric Data Display

The following are displayed in Navigation Status area according to operating conditions:

- Normal operation: AIS-SART ACTIVE (14)
- Trial operation: AIS-SART TEST (15)

If displaying "AIS-SART TEST (15)", it indicates that the AIS-SART operation test is performing.

Section 6 Functions of the ECDIS

6.1 General Flowchart

A general flowchart of sailing using the ECDIS is shown.

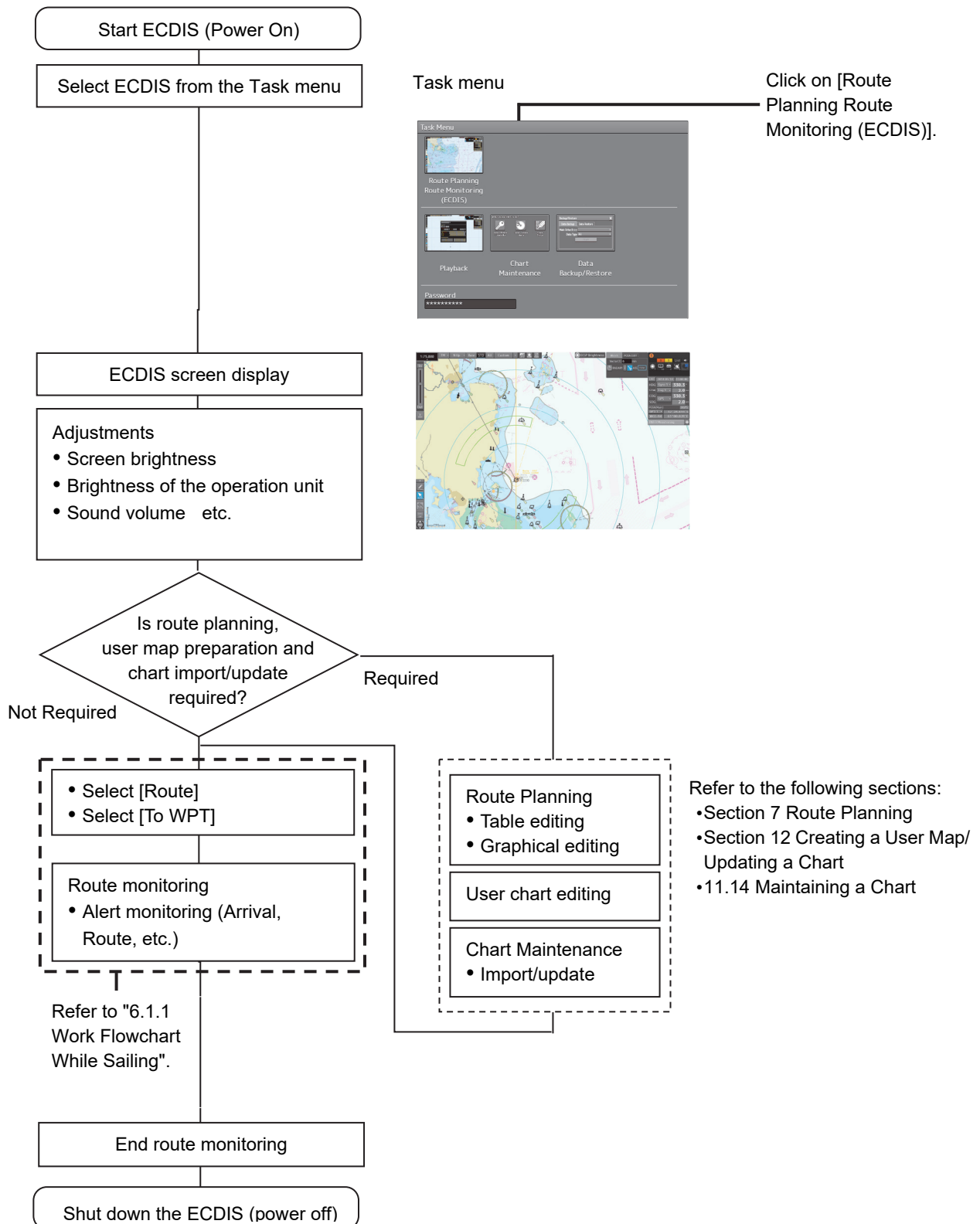

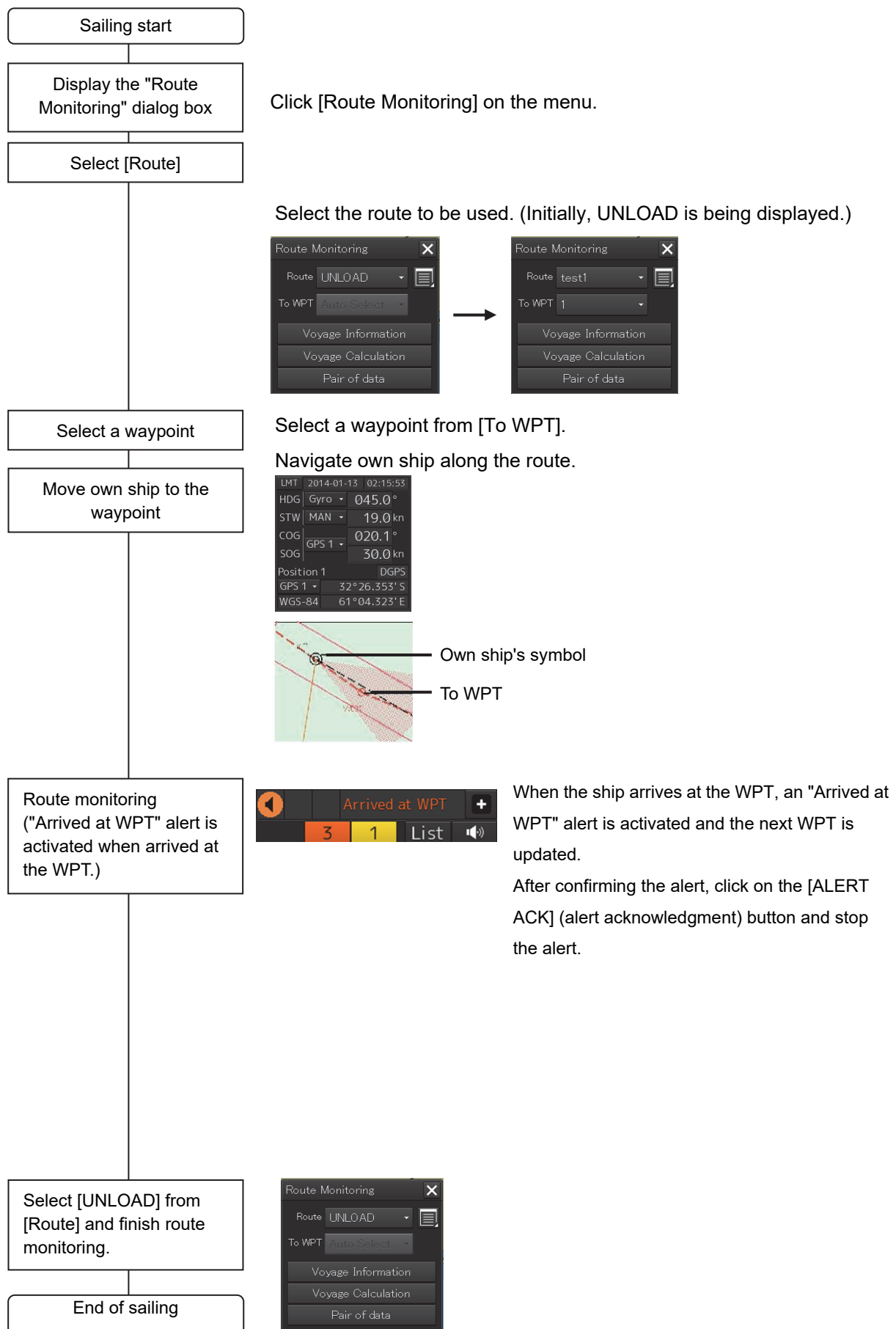

6.1.1 Work Flowchart While Sailing



6.2 Starting and Preparing the ECDIS

6.2.1 Powering on and starting

The ECDIS is powered on according to the following procedure.

|  CAUTION | |
|--|--|
|  | Do not leave the disc in the DVD drive. Malfunctions of the drives may result. |
|  | For low-temperature start-up, perform pre-heat for more than 30 minutes. Otherwise, an operation failure may occur and an accident may occur. |

6

1 Press the Power ON button on the operation unit.

The Power button illuminates. After a while, the Task menu is displayed.

6.2.2 Starting the ECDIS

6.2.2.1 Starting the ECDIS from the Task Menu

When the ECDIS is started, the Task menu appears on the screen.

Start the ECDIS from the Task Menu.

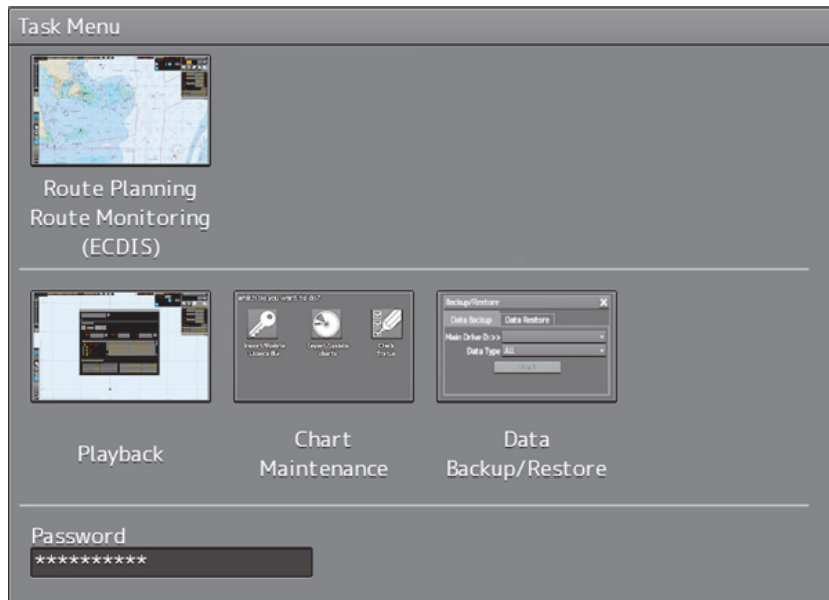

- 1 Click on the [Route Planning Route Monitoring (ECDIS)] button on the Task menu.

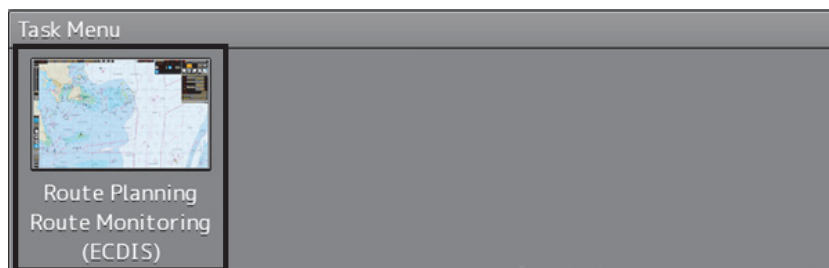

The ECDIS screen is displayed.

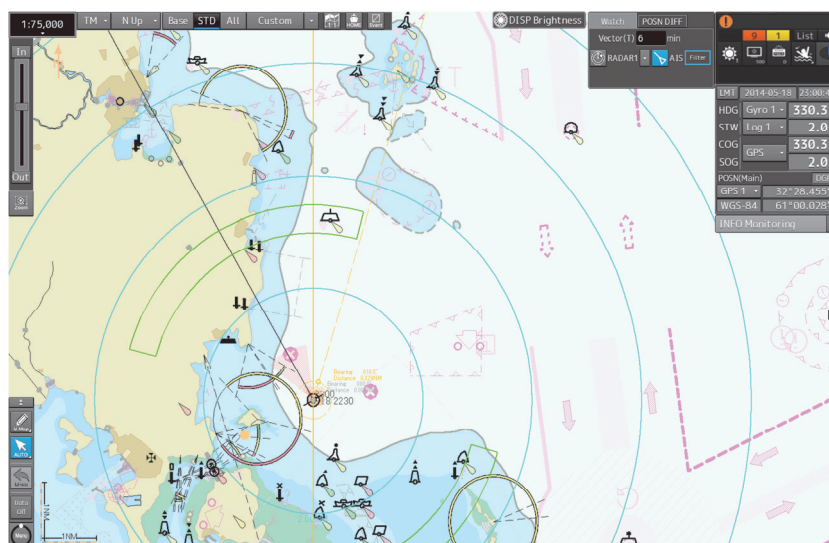

6.2.2.2 Starting ECDIS from a non-ECDIS task screen

Note

In case of JAN-7201S/9201S, there is not task switching buttons of [RADAR], [ECDIS], [CONN] and [CAM] by function restriction.



There is not task switching button

6.2.3 Entering an ARCS PIN Number (ARCS Only)

When ARCS charts have been imported, the ARCS PIN code input dialog box appears when the ECDIS is started.

Since ARCS is restricted by the ARCS PIN number, ARCS is not displayed unless the correct ARCS PIN number is input.

To use ARCS charts, be sure to perform the following operation.

1 Input a PIN number in [ARCS PIN] of the [ARCS PIN] dialog box

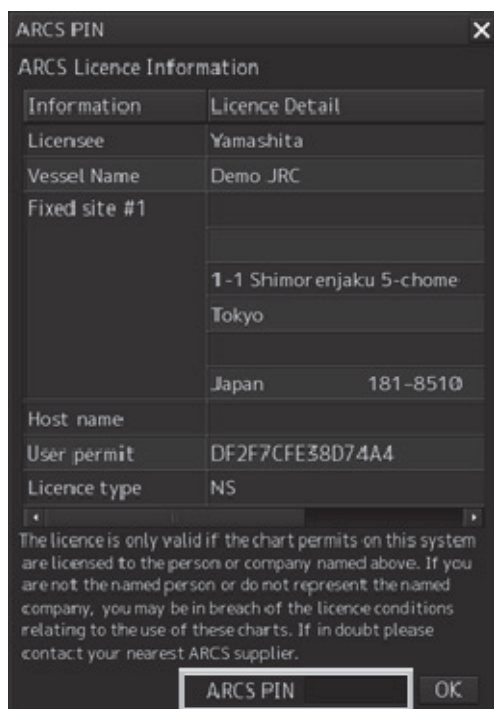

2 Click on the [OK] button.

When the [X] button is clicked on, ECDIS starts without displaying ARCS.

Note

ARCS is not displayed when the contract has expired even if the correct ARCS PIN number is input.

Memo

It is necessary to enter an ARCS PIN code only when the ECDIS screen will be displayed for the first time.

6.3 Moving the Chart

Charts can be moved by the following methods.

- Moving by the [Home] button
- Moving by the cross-hair cursor
- Moving by the hand cursor
- Switching display from the [My Port List] dialog box
- Displaying by entering a position

6.3.1 Moving the chart with the [HOME] button

Display can be moved to a position where the heading direction of own ship can be observed in a panoramic view. Use this feature if own ship is lost from charts.

- 1 Click on the [Home] button in Chart Information Area.

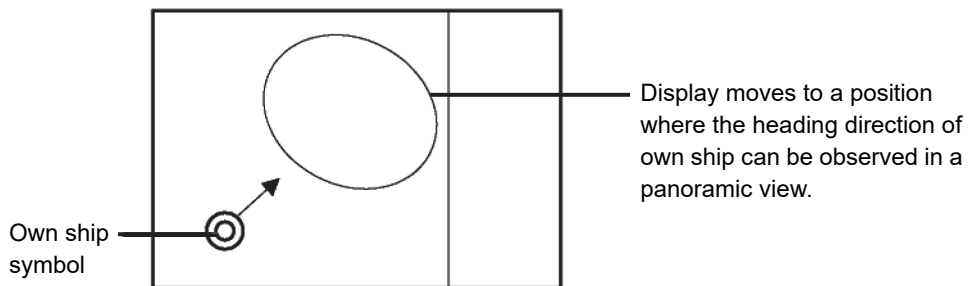

Screen Display of Home Position

6.3.2 Moving the chart with the cross-hair cursor

When the cross-hair cursor is moved to an arbitrary position on the chart and then clicked, the chart can be moved. The chart moving position varies with the setting of the motion mode.

For information about the motion mode, refer to "6.6 Selecting Motion/Bearing Mode".

[When the motion mode is set to true motion]

The position of the cross-hair cursor becomes the center of the screen.

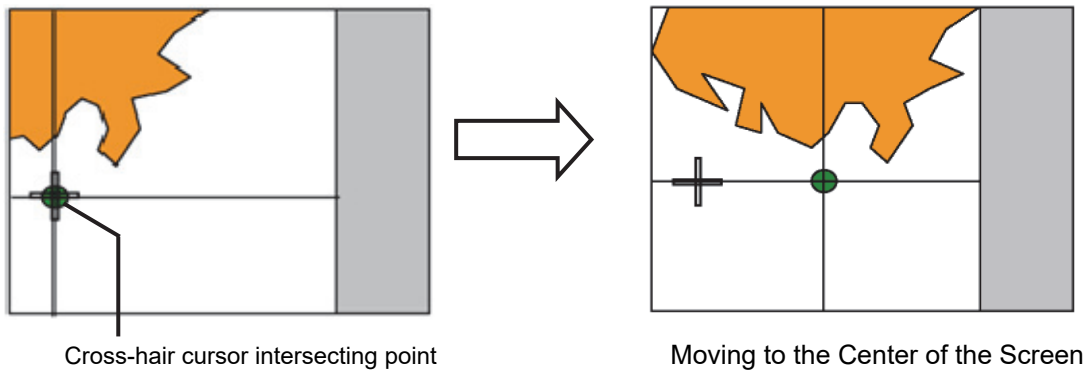

[When the motion mode is set to relative motion]

The position of the cross-hair cursor becomes own ship's display position.

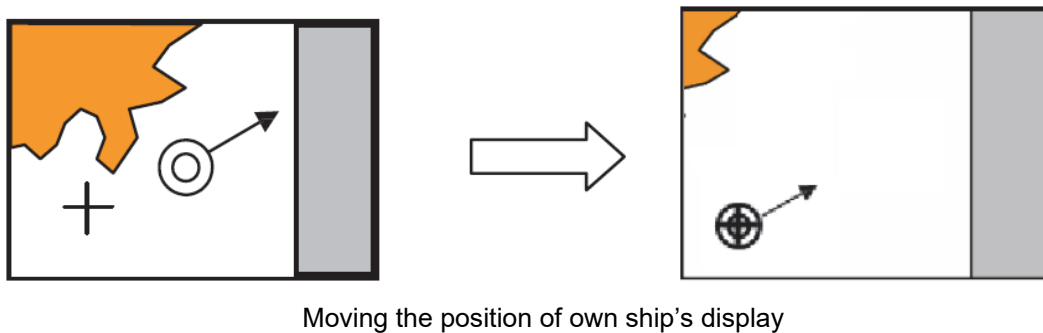

6.3.3 Moving the chart with the hand cursor

The chart can be moved by grabbing it with the hand cursor.

- 1 Move the cursor to the position where you want to grab the chart.
- 2 When the trackball is turned while the button is pressed, the cursor changes to a hand cursor and the chart moves.

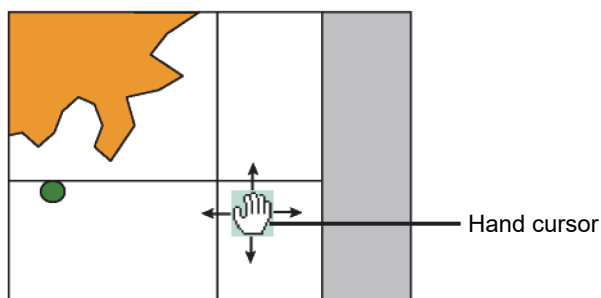

Memo

If own ship sails outside of the screen, the motion mode will automatically be set to Free (free motion).

6.3.4 Switching a chart to be displayed by "My Port List"

If port names are registered in My Port List in the [My Port List] dialog box, chart display can be switched to the one having the latitude and longitude of a registered port at the center of the chart.

- 1 Click on the [Menu] button on the left toolbar.**

The menu is displayed.

- 2 Click on [Chart] - [My Port List] on the menu.**

The [My Port List] dialog box appears.

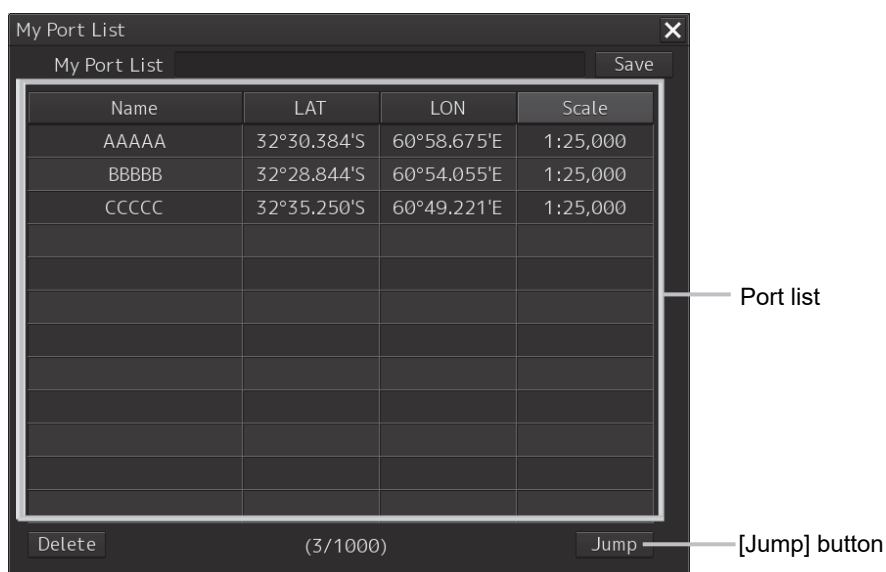

For how to register and delete ports, refer to "6.7 Registering and Displaying My Port List".

- 3 Click on a port in the list to select it.**

- 4 Click on the [Jump] button.**

The chart is displayed having the latitude and longitude of the selected port at the center of the chart.

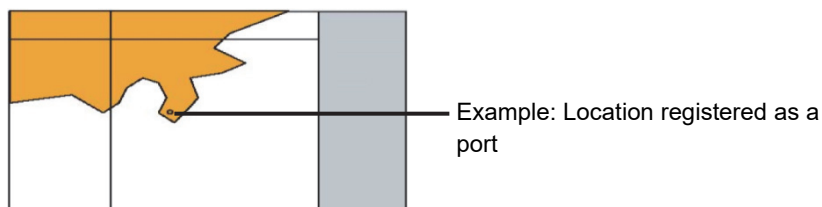

6.3.5 Displaying the chart by entering the position

By entering a position, the chart of a desired position can be displayed.

- 1 Click on the [Menu] button on the left toolbar.**
The menu is displayed.
- 2 Click on [Chart] - [Off Center by Entering Position] on the menu.**
The [Off Center by Entering Position] dialog box appears.

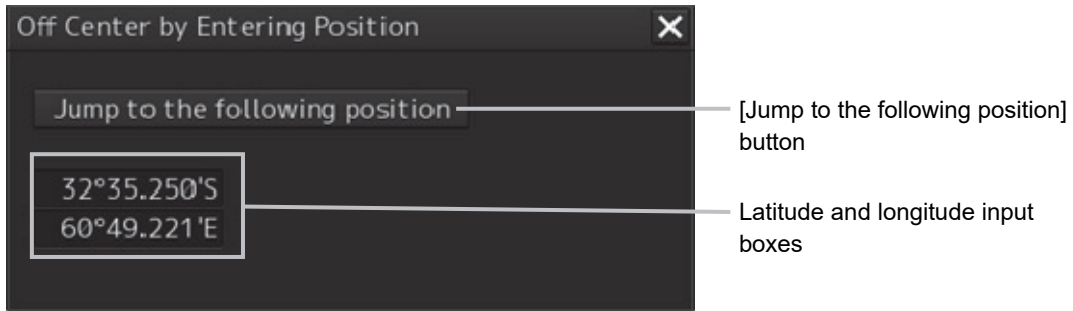

The latitude and longitude of the center of the current screen is displayed in the latitude and longitude input boxes.

- 3 Click the latitude and longitude input boxes.**
- 4 Enter the latitude and longitude of the chart you want to display with the software keyboard.**

Memo

The maximum latitude input range is 85 ° 00.000 (polar range restriction).

- 5 Click on the [Jump to the Following Position] button.**
The chart is displayed having the entered latitude and longitude at the center of the chart.

6.4 Zooming In/Out the Chart

The chart can be enlarged and reduced by the following methods.

| Item | Related sections |
|--|--|
| Enlarging a selected area | 6.4.1 Enlarging a Selected Area (S-57/C-MAP Only) |
| Enlarging/reducing with the [ZOOM IN]/[ZOOM OUT] key on the operation unit (S-57/C-MAP only) | 6.4.2.1 Enlarging/reducing with the [ZOOM IN]/[ZOOM OUT] key on the trackball operation unit |
| Enlarging/reducing with the zoom slider (S-57/C-MAP only) | 6.4.2.2 Enlarging/reducing with the zoom slider (S-57/C-MAP only) |
| Enlarging/reducing with the Large/Small buttons (RNC only) | 6.4.2.3 Enlarging/reducing with the [Large]/[Small] buttons (RNC only) |

6.4.1 Enlarging a Selected Area (S-57/C-MAP Only)

A selected area can be enlarged to the full chart screen size.

- 1 Click on the [Zoom Area] button.

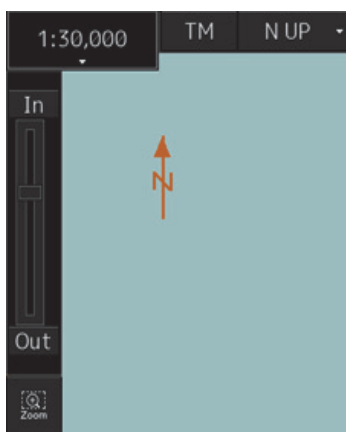

[Zoom Area] button

The cross-hair cursor changes to a zoom cursor.



- 2** Using the trackball, move the cursor to "A" located at the upper left of the range you want to enlarge, and then click.
- 3** Using the trackball, move the cursor to "B" located at the lower right of the range you want to enlarge, and then click.

The enlarging range is enclosed with a rubber band and then that range is enlarged to the full screen size.

Once enlarged, the zoom cursor changes back to the cross-hair cursor.

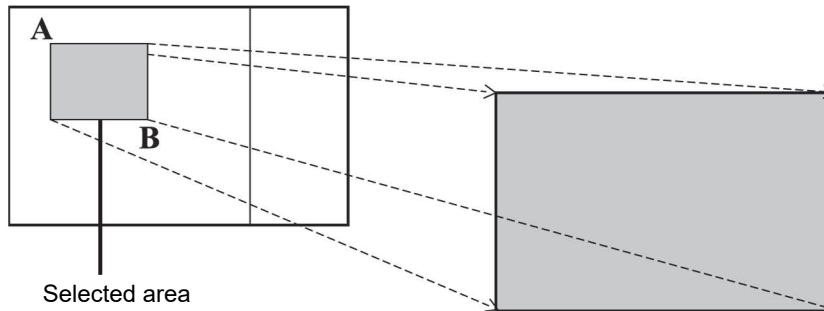

Memo

Switching charts

- Generally, multiple charts with different scales are provided for the same area; charts having matching scale values are selected/displayed by enlargement or reduction.
- When a displayable scale range is assigned to an original scale of a chart and the original scale is beyond this range, the chart will not be displayed unless there are other displayable charts.
- This equipment is equipped with a world map background chart as the reference chart and the chart is always displayed in background.

6.4.2 Enlarging/reducing a chart with the Zoom function

6.4.2.1 Enlarging/reducing with the [ZOOM IN]/[ZOOM OUT] key on the trackball operation unit (S-57/C-MAP only)

- 1 Each time the [ZOOM IN] key is pressed, the chart is enlarged according to the range or scale that has been set up.
Each time the [ZOOM OUT] key is pressed, the chart is reduced according to the range or scale that has been set up.

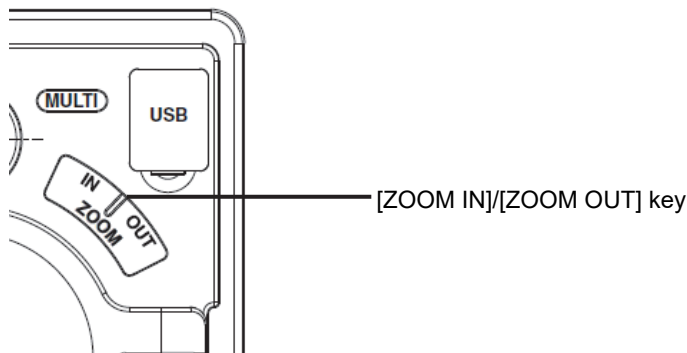

For the details of switching between range and scale, refer to "6.4.3 Switching between scale and range (S-57/C-MAP only)".

6.4.2.2 Enlarging/reducing with the zoom slider (S-57/C-MAP only)

- 1 When the slider handle is clicked upward, display is enlarged. When it is clicked downward, display is reduced.
Each time the [In] (zoom in) button is clicked on, the chart is enlarged according to the range or scale that has been set up.
Each time the [Out] (zoom out) button is clicked on, the chart is reduced according to the range or scale that has been set up.

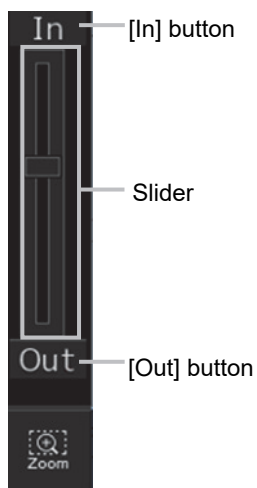

For more information about switching between range and scale, refer to "6.4.3 Switching between scale and range (S-57/C-MAP only)".

Memo

Over Scale caution

When the ship enters a different chart, an over-scale activated if the displayed chart is more than double in size than the original data. The vertical lines as seen in the figure below will be displayed on the "chart" to notify lower chart accuracy and clarity. The vertical lines will not be displayed if the size has been made larger (double or more) through proper operation.

An "Over Scale" caution is displayed in the alert display area.

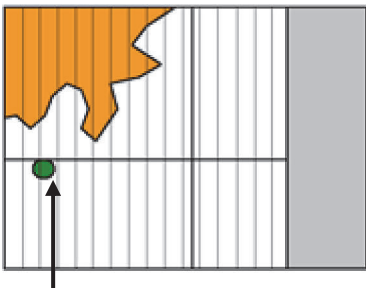

Notification line at Over Scale



Alert display area

Case in which an Over Scale caution is not displayed (1)

When a single cell is displayed in full screen with the scale exceeding double the compilation scale, the Over Scale warning line is not displayed. However, an "Over Scale" caution is displayed.

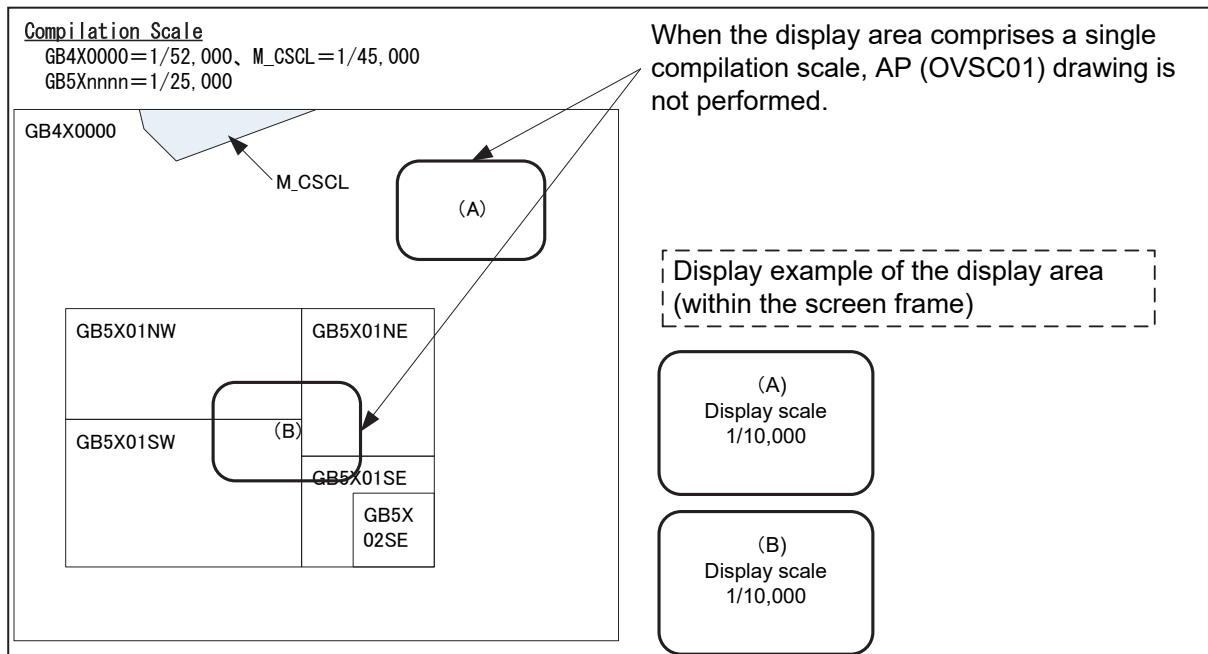

Case in which an Over Scale caution is not displayed (2)

When multiple cells exist within the screen frame in the scale exceeding double the compilation scale, an Over Scale warning line is not displayed in cells other than the cell of the minimum scale.

However, warning display is performed and an “Over Scale” caution is displayed.

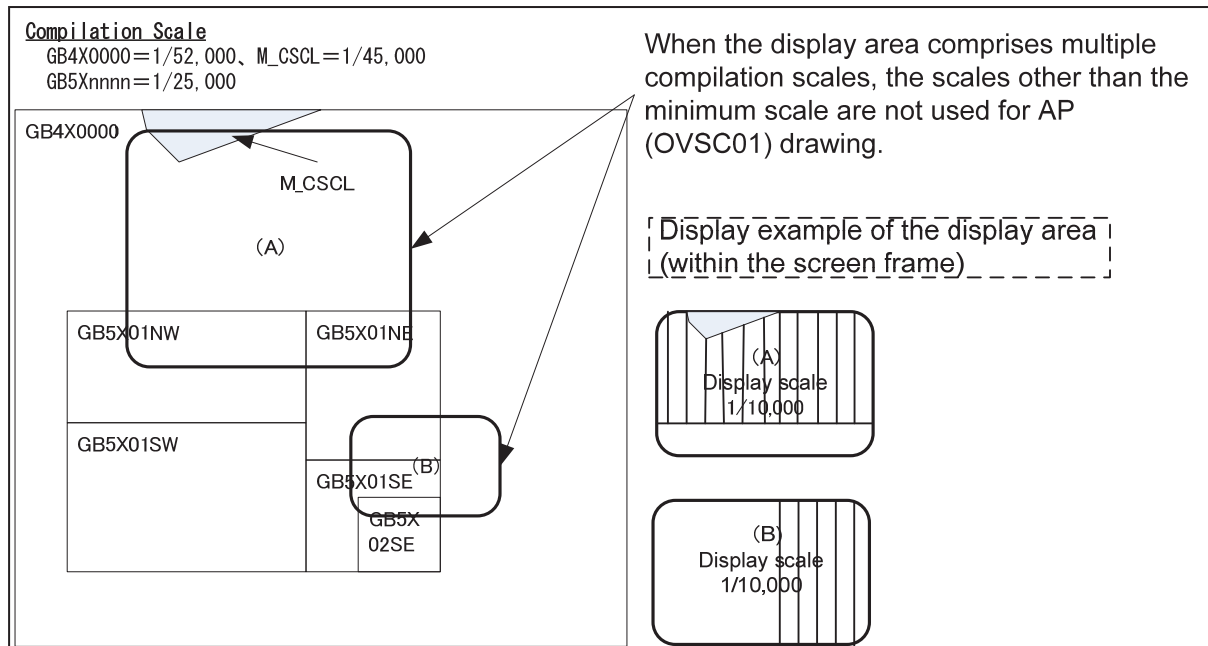

6.4.2.3 Enlarging/reducing with the [Large]/[Small] buttons (RNC only)

- Each time the [Large] button is clicked on, the chart is enlarged by one scale level (larger scale charts).
 Each time the [Small] button is clicked on, the chart is reduced by one scale level (smaller scale charts).

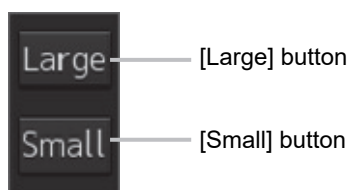

6.4.3 Switching between scale and range (S-57/C-MAP only)

The current scale or range is displayed on the Scale/Range button in Chart Information Area.



The settings of scale and range as well as their switching method are as follows.

1 Click on the Scale/Range button.

The scale and range settings menu appears.

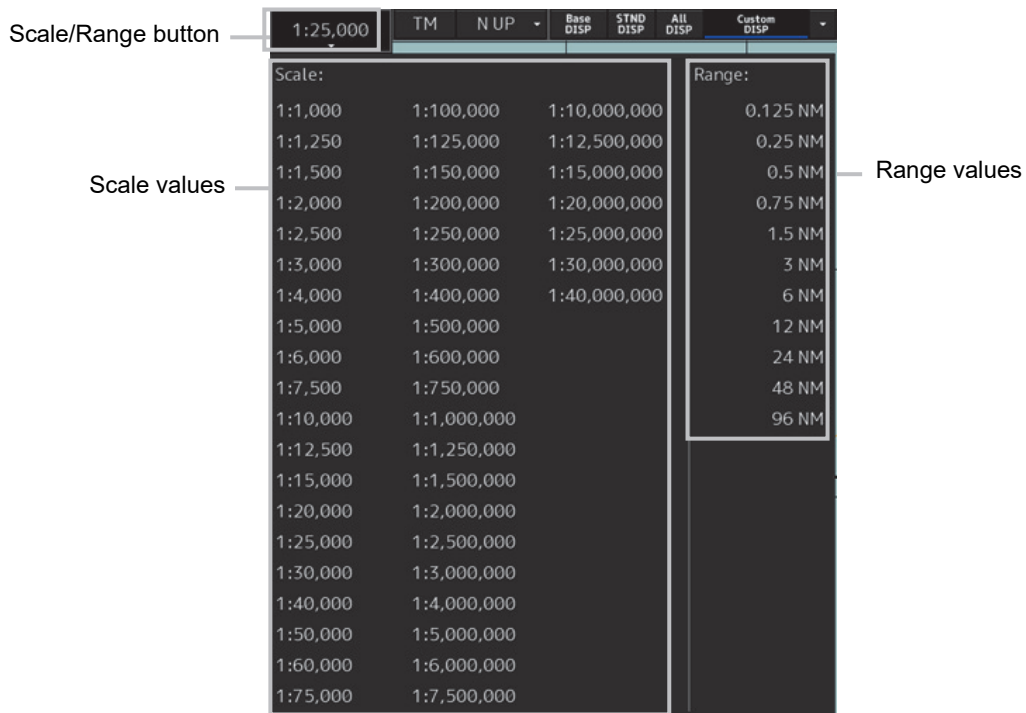

2 Select a scale or range value from the menu.

The chart is displayed having the selected scale or range.

Memo

For range display, the half of the screen width becomes the specified range when displayed.

For a multi screen (refer to “6.10 Multi View Display and Wide Range View Window Display of Charts”), the half the display screen View1/View2 becomes the specified range when displayed.

6.5 Changing the Object Category (S-57/C-MAP Only)

SENC (System Electronic Navigation Chart) information available for display in the chart is subdivided into three object groups; Base (Base display), STD (Standard Display), and All (All display). You can change the object category using the display panel.

Base (Base Display)

A group of important objects that cannot be deleted from the charts (coastline and safety contour lines)

STD (Standard: Standard display)

A group of objects less important than base display (fixed and floating objects for monitoring)

All (All display)

All objects

Custom (Custom)

Refer to "6.5.2 Customizing object display"

Memo

About display in the chart

Display in the chart can be considered as the composite of various layers. For example, STD (Standard: Standard display) is the composite of object layers for Base (Base display) and object layers for STD (Standard: Standard display).

In addition to the object layers of the S-57/C-MAP charts themselves, own ship, user charts, event marks, EBL/VRM, radar images, etc. can be combined and then displayed.

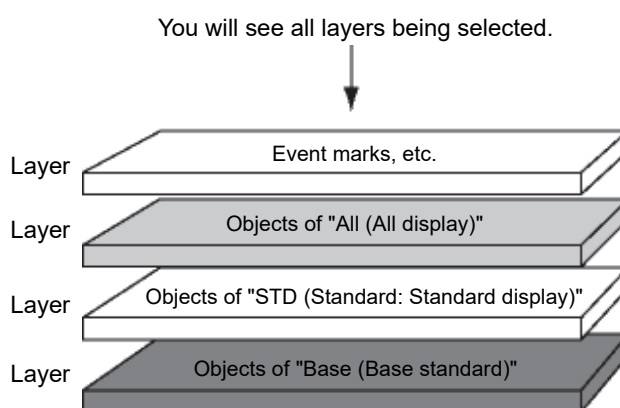

Note

The initial chart screen status is "STD (Standard: Standard display)". For safe sailing, use the "STD (Standard: Standard display)" or "All (All display)", not the "Base (Base display)".

6.5.1 Switching object display

- 1 Click on one of the buttons of the Chart Information Area display category.



Information displayed on the chart changes.

6

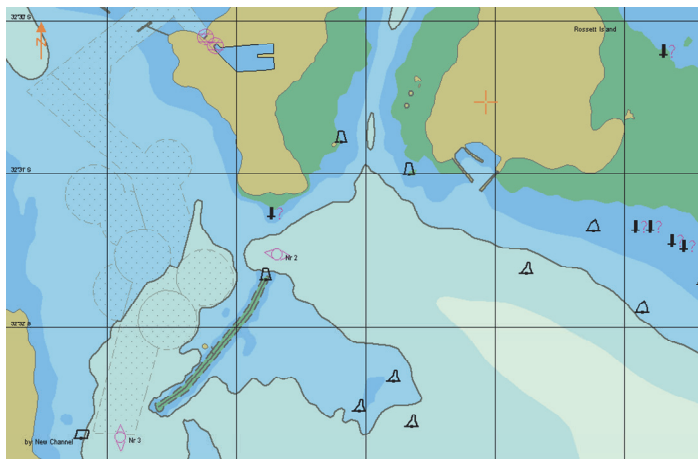

"Base (Base display)" Example

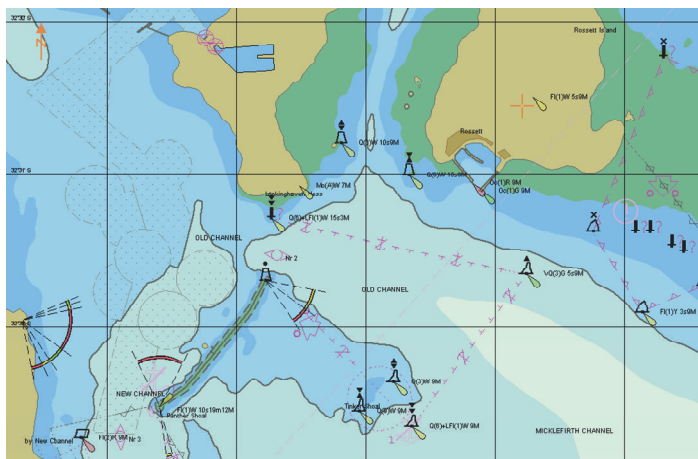

"STD (Standard: Standard display)" Example

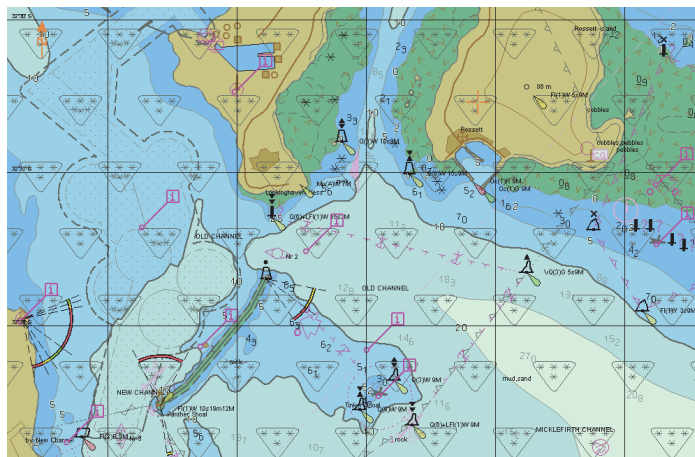

"All (All display)" Example

Note

The display will be in gray without displaying a chart when a corresponding chart does not exist in the display area, when a chart exists with only a part of data, or when the display scale does not match the chart scale. In this case, change the scale to check for a chart can be displayed.

6.5.2 Customizing object display

When the [Custom] button of the Chart Information Area is clicked on, the object corresponding to the setting in the [Chart Display] dialog is displayed.

Any of the objects that are displayed on the [Chart Display] dialog can be set.

- 1 Click on the [Custom] menu display button.



The display changes as follows.

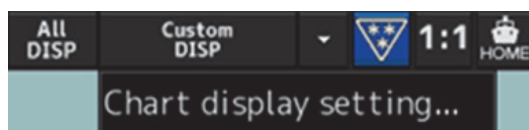

2 Click on the [Chart display setting] button.

[Chart Display] dialog is displayed.

The edit pane is divided into three dialogs.

To advance to the next dialog: Click on the [Next] button.

To return to the previous dialog: Click on the [Back] button.

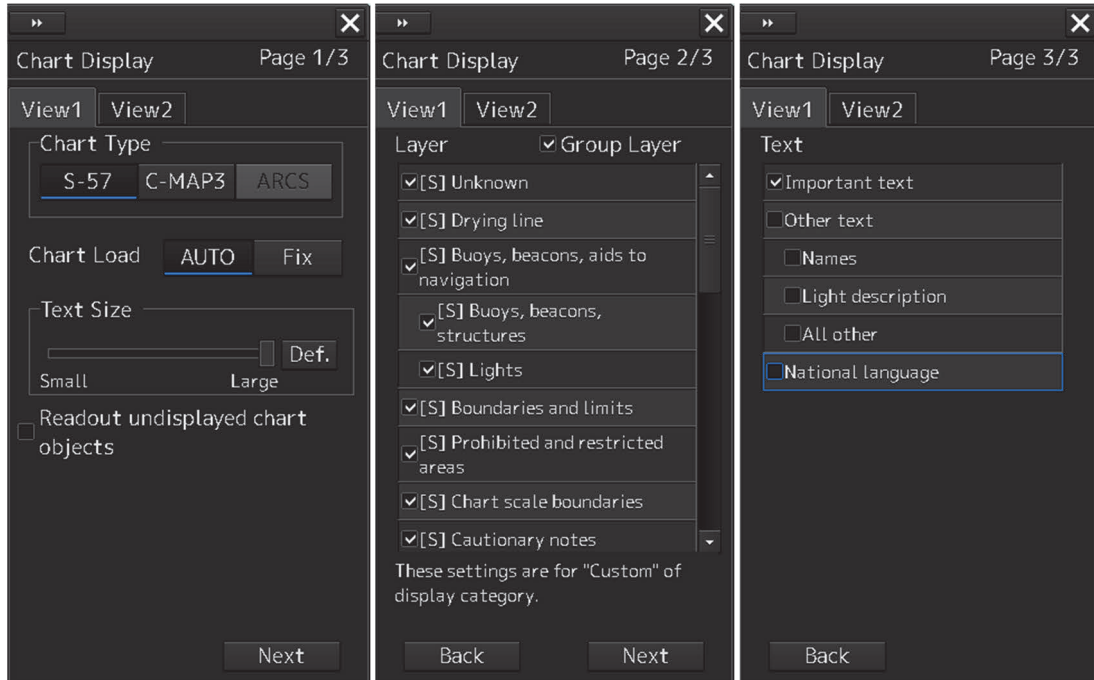

3 Set the object to be displayed.

For the setting of the [Chart Display] dialog, refer to "14.2.10 Setting up the display of Chart Common".

Memo

The [Chart Display] dialog can also be displayed by selecting [View] - [Options] - [Chart Display] on the menu.

6.6 Selecting Motion/Bearing Mode

Using the Motion/Bearing Mode combo box in Chart Information Area, set up the motion mode and the bearing mode on own ship's chart. The mode that can be selected varies with the chart type.

S-57/C-MAP Ed.3 Charts



Motion mode button Bearing mode button

[Selectable combinations in the motion mode and the bearing mode]

| Motion mode \ Bearing mode | Bearing mode | | | |
|----------------------------|--------------|------|------|--------|
| | N UP | H UP | C UP | WPT UP |
| TM | ○ | × | ○ | × |
| RM | ○ | ○ | ○ | ○ |
| Free | ○ | × | ○ | × |

ARCS Charts



Motion mode button

*The bearing of the ARCS chart is fixed to N UP.

6.6.1 Setting motion mode

Set a motion mode with the Motion Mode button in Chart Information Area.

- 1 Display the current Motion Mode.
- 2 Change TM/RM/Free by short pressing the button to the left.

| Setting item | Description | Display image |
|--------------|--|---|
| [TM] | <p>True Motion Mode</p> <ul style="list-style-type: none"> Land and other fixed objects are fixed on the display and only own ship moves on the display. When own ship reaches the predetermined limit, the chart is automatically shifted so that own ship always remains on the screen. | <p>The diagram shows a grid with a heading line. A fixed object is labeled 'Fixed' and remains stationary. The 'Own ship' is shown moving along the heading line. The chart area is shaded green.</p> |
| [RM] | <p>Relative Motion Mode</p> <ul style="list-style-type: none"> Own ship is fixed at the center of the screen and the fixed objects such as land move relatively. | <p>The diagram shows a grid with a heading line. The 'Own ship' is fixed at the center. A fixed object is labeled 'Fixed on ship position' and moves relative to the ship's position. The chart area is shaded green.</p> |
| [Free] | <p>Free</p> <ul style="list-style-type: none"> You can freely move the chart on the display regardless of the own ship's direction. As the own ship goes, it disappears from the screen. | <p>The diagram shows a grid with a heading line. The 'Own ship' is shown moving. A fixed object is labeled 'Fixed' and remains stationary. The chart area is shaded green.</p> |

Mode change by the operation:

In the following cases, the motion/bearing mode will be automatically changed from the current mode to another one.

- From [TM] mode to [Free] mode:
 - When an area outside of the own ship range was displayed by loading charts or clicking the [Jump] button in the [My Port List] dialog box.
- From [RM] mode to [Free] mode:
 - When the own ship goes exceeding the display limit of the screen by scrolling the chart.
 - When an area outside of the own ship range was displayed by loading charts or clicking the [Jump] button in the [My Port List] dialog box.
- From [Free] mode to [TM] mode:
 - When the [Home] button was clicked on,
the rotation in the Free mode is retained after changing to the TM mode.

| |
|-------------|
| Note |
|-------------|

| |
|--|
| H UP, WPT UP, C UP are valid only the chart scale is not lower than 1:5,000,000. |
|--|

6.6.2 Setting Bearing mode (S-57/C-MAP only)

Set a bearing mode with the Bearing Mode button in Chart Information Area.

- 1 Click on the Bearing Mode combo box.
- 2 Select a bearing mode.

| Setting item | Description | Display image |
|--------------|---|---------------|
| [N UP] | <p>North up</p> <ul style="list-style-type: none"> The chart is always displayed towards true north. Fixed objects do not flicker and are easily identified on the chart, and the true bearing of the objects can readily be read out. | |
| [H UP] | <p>Head up</p> <p>The chart is displayed by orienting the ship's heading upward. Cannot be selected under TM (true motion).</p> | |
| [C UP] | <p>Course up</p> <ul style="list-style-type: none"> At the setting of Course Up, the ship's heading (HDG) is fixed and displayed immediately above the screen. | |
| [WPT UP] | <p>Way point up</p> <ul style="list-style-type: none"> The chart rotates automatically so that the screen is always oriented upward until the target WPT. | |

| Setting item | Description | Display image |
|------------------------------|--|--|
| [C UP (Angle Setting)] | <p>Course UP by angle setting</p> <ul style="list-style-type: none"> When this item is selected, the [C UP (Angle Setting)] dialog box appears. The course angle that was set on the dialog is displayed right above the chart and fixed. <div data-bbox="488 477 890 663" data-label="Image"> </div> <ul style="list-style-type: none"> Input the angle of the ship's heading in the [Angle] input box of the [C UP (Angle Setting)] dialog box. The angle can be input (increase/decrease) by operating the angle input slider. After completing the setting, click on the [X] button. | <div data-bbox="986 224 1353 497" data-label="Image"> </div> |

Display changes according to the selected bearing mode.

6.7 Registering and Displaying My Port List

6.7.1 Registering to My Port List

You can register any position on the chart to the [My Port List] dialog box. After registration, you can directly access to that position by selecting a port name from the My Port List.

1 Set the location to be registered.

S-57/C-MAP

Since the center position and the display scale of the screen that is currently displayed are registered in the port name list, move the location to be registered to the center of the screen in advance.

To display another position, shift the chart area (refer to "6.3 Moving the Chart") or zoom in to/out from the chart. (Refer to "6.4 Zooming In/Out the Chart".

ARCS

Since the center position and the display scale of the screen that is currently displayed are registered in the port name list, move the location to be registered to the center of the screen in advance.

To display another position, please refer to "6.9.1 Selecting charts from all".

2 Click on the [Menu] button on the left toolbar.

The menu is displayed.

3 Click [Chart] - [My Port List] on the menu.

The [My Port List] dialog box appears.

In the [My Port List] dialog, the Name, LAT (latitude), LON (longitude), and display Scale (scale) of the port that is currently registered are displayed.

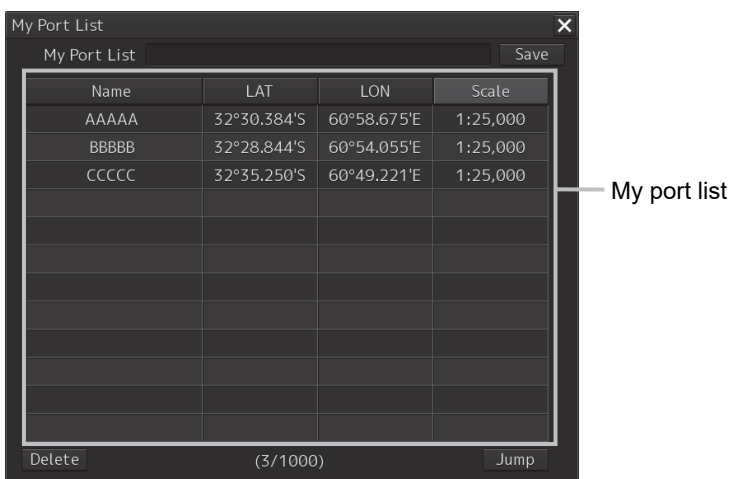

4 Enter the registration name of the port in the [My Port List] (port name) input box.

5 Click on the [Save] button.

The coordinates (latitude and longitude) of the center of the chart display and the display scale according to the registration name designated in the step 4 are registered in the list as the port.

6.7.2 Deleting a port

1 Click on the [Menu] button on the left toolbar.

The menu is displayed.

2 Click [Chart] - [My Port List] on the menu.

The [My Port List] dialog box appears.

3 Click on the port to be deleted from the My Port List.

The port is selected.

4 Click on the [Delete] button.

The selected port is deleted from the My Port List.

6.8 Selecting a S-57 chart

Because the chart of own ship's position is automatically called up after power on, generally route monitoring can be performed instantly.

If you want to display charts other than the chart automatically called up, select a chart from those that are displayed by selecting [Chart] - [Select S-57 Chart] on the menu.

For the details, refer to "11.2 Displaying/Searching an S-57 Chart [Select S-57 Chart]".

6.9 Selecting an ARCS chart

This section describes chart selection and the functions on the display, which are available on the ARCS chart.

6.9.1 Selecting charts from all

You can select desired charts from all the charts stored in this system.

- 1 Click on the [Select] button in Chart Information Area.

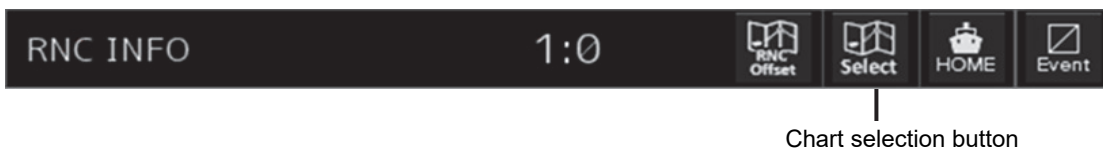

The [Select Chart] dialog box appears.

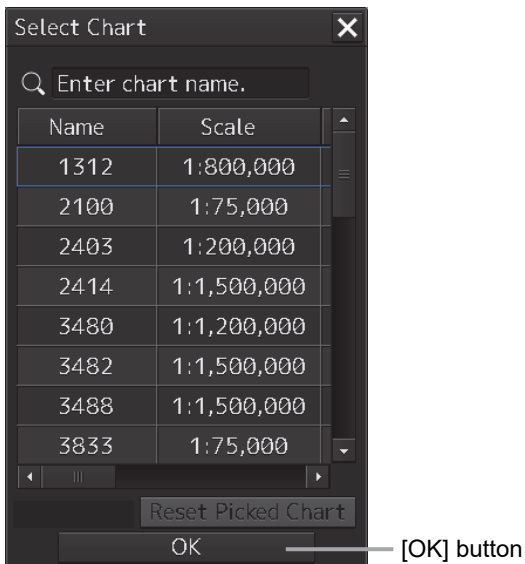

- 2 Select the desired chart in the list by clicking it and then click on the [OK] button.

The selected chart is displayed on the screen.

6.9.2 Changing active panels (ARCS only)

The active panel on the chart can be changed.

- 1 Right-click on the chart**
The context menu is displayed.
- 2 On the Context menu, click on the [Change Active Panel].**
The selectable active panel painted in blue is displayed.
- 3 Click on in the blue panel. The corresponding chart is then displayed.**

6

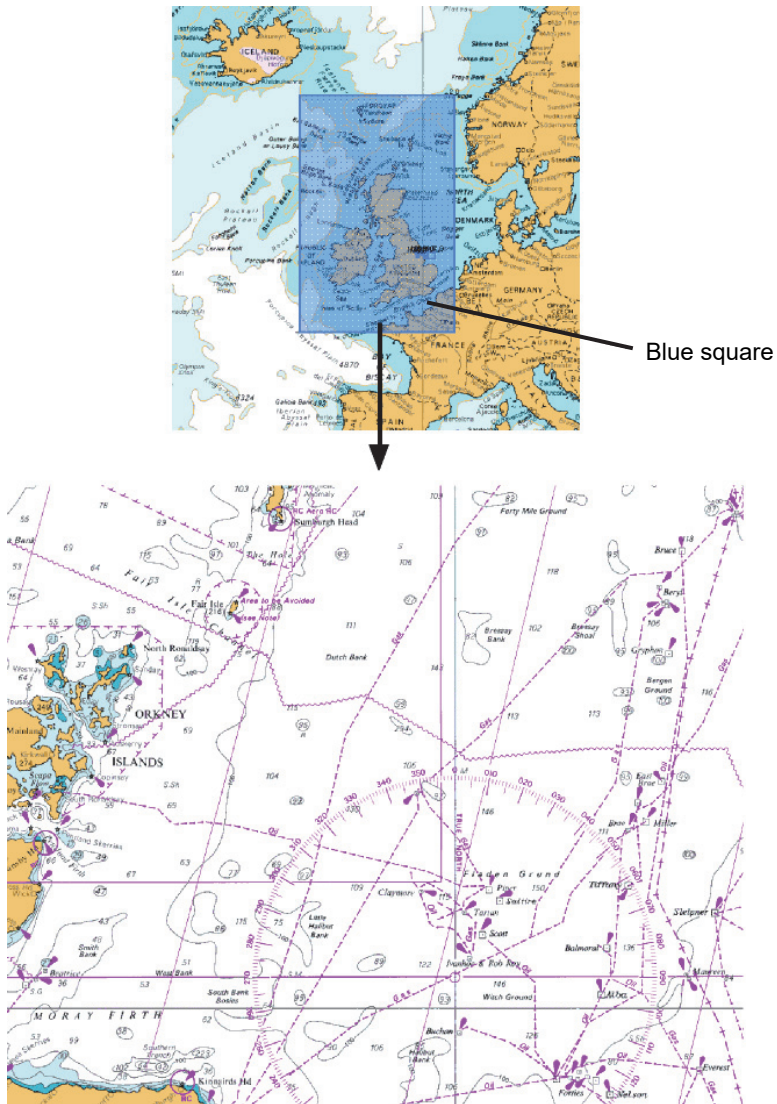

Selected chart

6.9.3 Changing a low resolution chart (ARCS only)

1 Right-click on the chart

The context menu is displayed.

2 On the Context menu, click on the [Load Low Resolution].

The low resolution chart is displayed on the screen.

6.9.4 Changing a high resolution chart (ARCS only)

- 1 Right-click on the chart**
The context menu is displayed.
- 2 On the Context menu, click on the [High Resolution Area].**
The cursor changes to the zoom cursor and an orange frame appears on the chart.
- 3 Move the cursor to the area to be expanded (the frame moves together with the cursor) and click the mouse button.**
The high-resolution chart in the area within the frame is displayed on the screen.

6

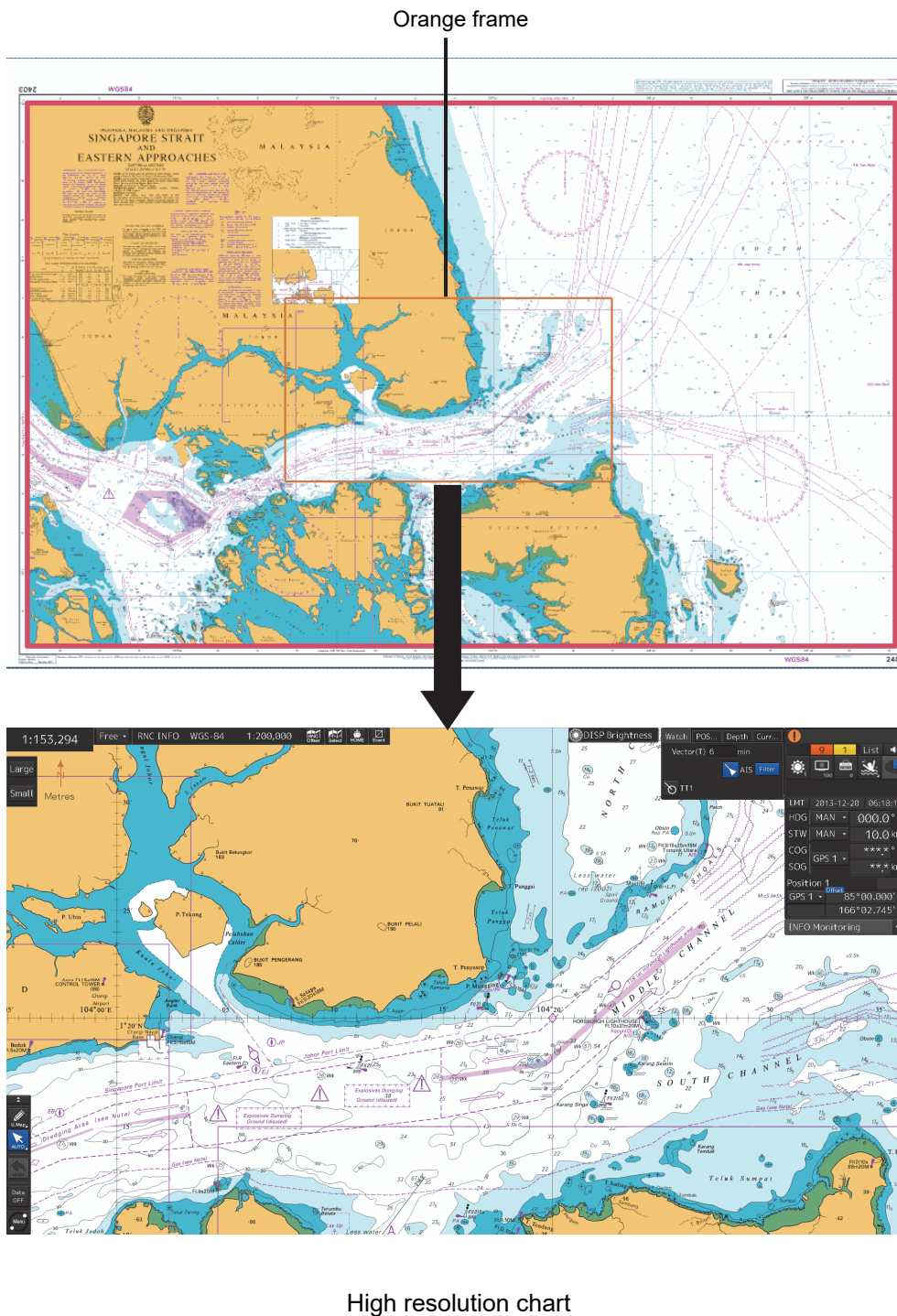

6.9.5 Displaying the note and diagram (ARCS only)

You can display the note and diagram list defined by the current chart.

1 Right-click on the chart

The context menu is displayed.

2 On the Context menu, click on the [Note and Diagram].

The [Note and Diagram] dialog box appears.

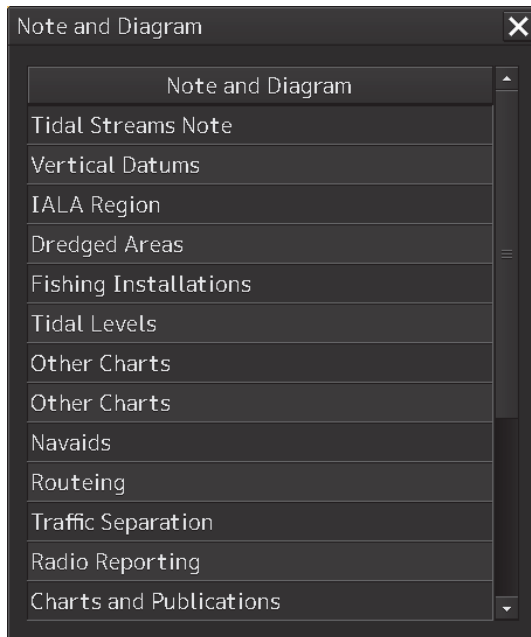

3 Click on the item you want to display. The note or diagram on the corresponding chart is displayed.

Clicking the [X] buttons, the dialog box is closed and the chart display returns to the original display position.

6.10 Multi View Display and Wide Range View Window Display of Charts

The multi view display function divides the chart window into two windows and displays the same chart or different charts separately in these two windows.

Note

ARCS and C-MAP Ed.3 cannot display charts of other models simultaneously.

6

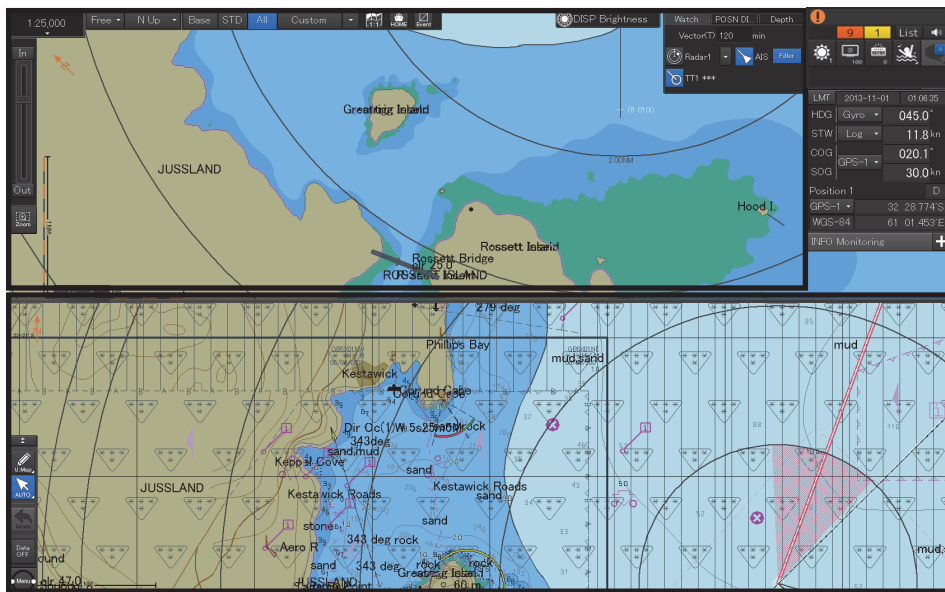

Example of Multi Window Display (Top-Bottom)

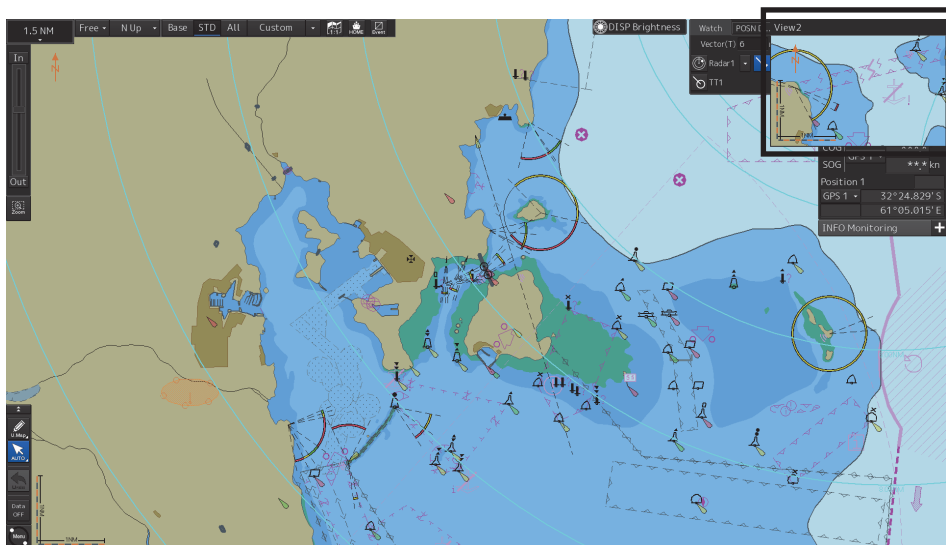

Example of Multi Window Display (Picture in Picture)

6.10.1 Display of multi view

6.10.1.1 Displaying multi view

- 1 Click on the [Menu] button on the left toolbar.
The menu is displayed.
- 2 Select [View] - [Multi View Mode] on the menu.
The [Multi View Mode] dialog box appears.

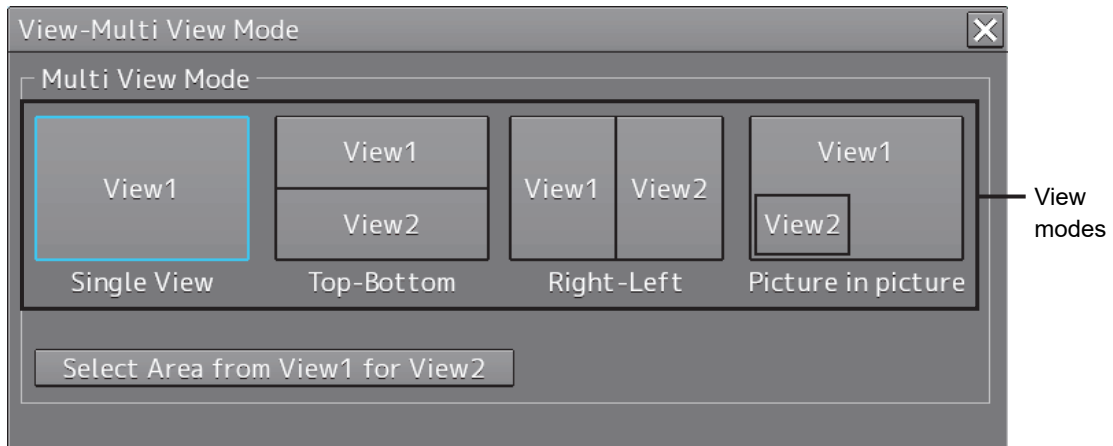

- 3 Click on a multi view mode to select it.
The selected multi view mode takes effect.

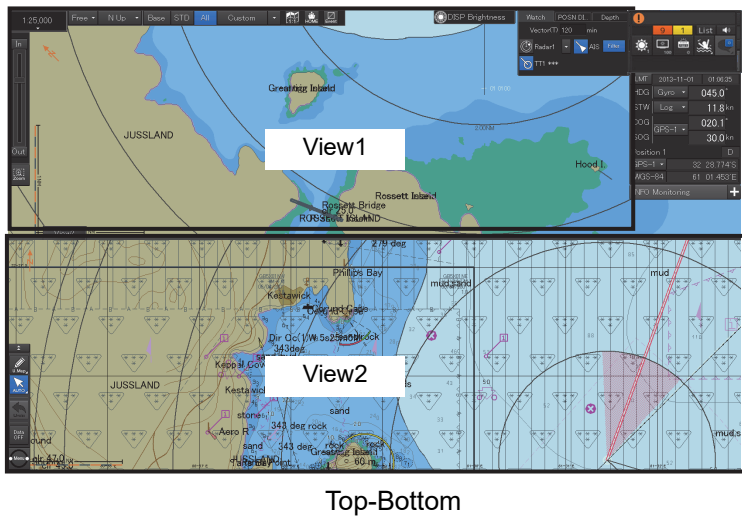

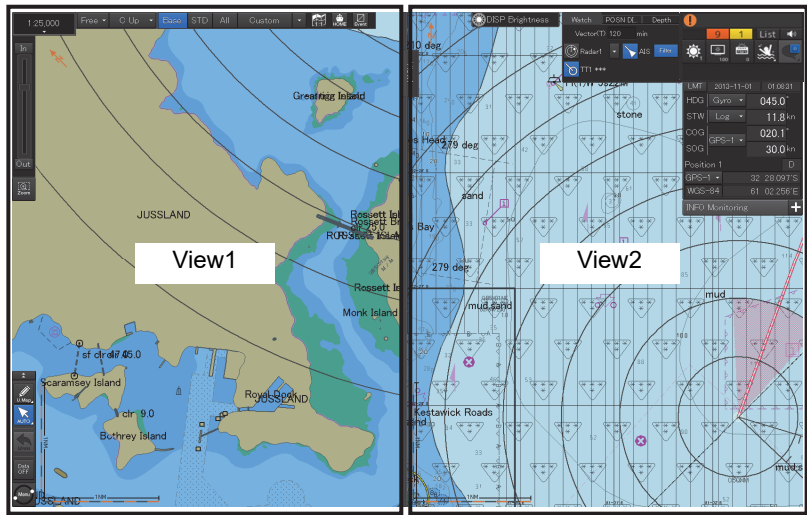

Right-Left

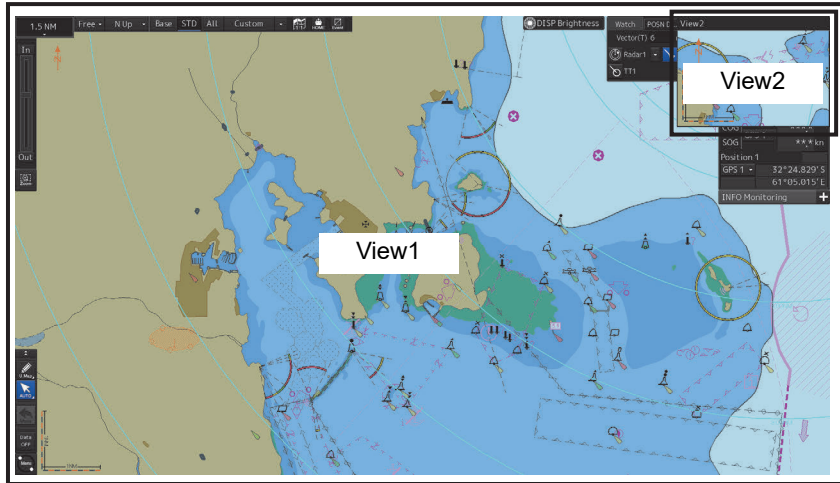

Picture in picture

6.10.1.2 Multi view operation procedure

[Operation When Manipulating Multi View]

- The same view is displayed in View1 and View2.
- Except for the items that can be set up separately in View2, View1 and View2 are displayed by linking.
- Rubber bands during create or edit operation (such as Route Planning) can only be displayed in active view.
- EBL/VRM and EBL maneuvers are shared between View1 and View2 and the same contents are displayed (however, the contents may differ depending on the setting of the measurement reference point).

Note

The bearing mode of View2 always operates by interlocking with the bearing mode of View1.

[Specifying an area to be displayed in View2]

In View1, you can specify an area you want to display in View2.

- 1 Click on the [Select Area from View1 for View2] button in the [Multi View Mode] dialog.

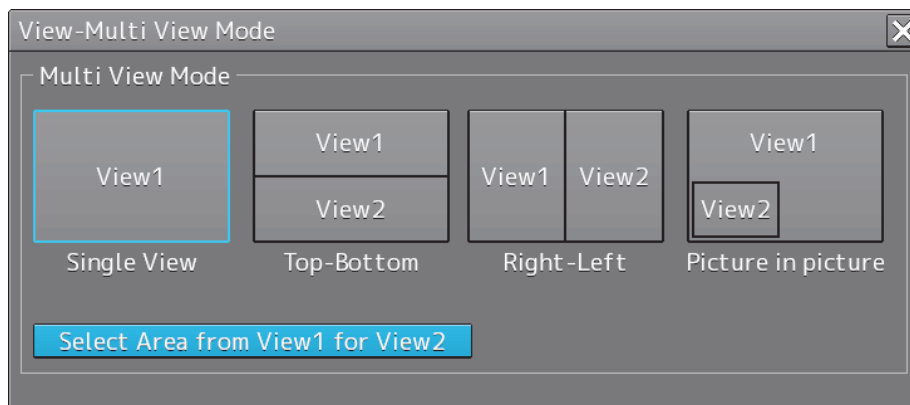

The button is displayed in reverse video.

2 Move the cursor to View1.

The cursor changes to the range selection cursor.

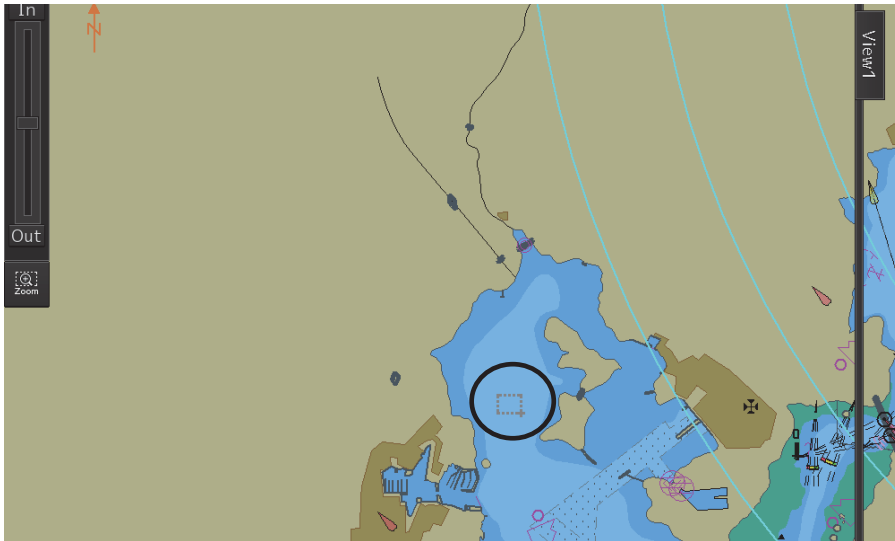

6

3 Drag the cursor and specify an area you want to display in View2.

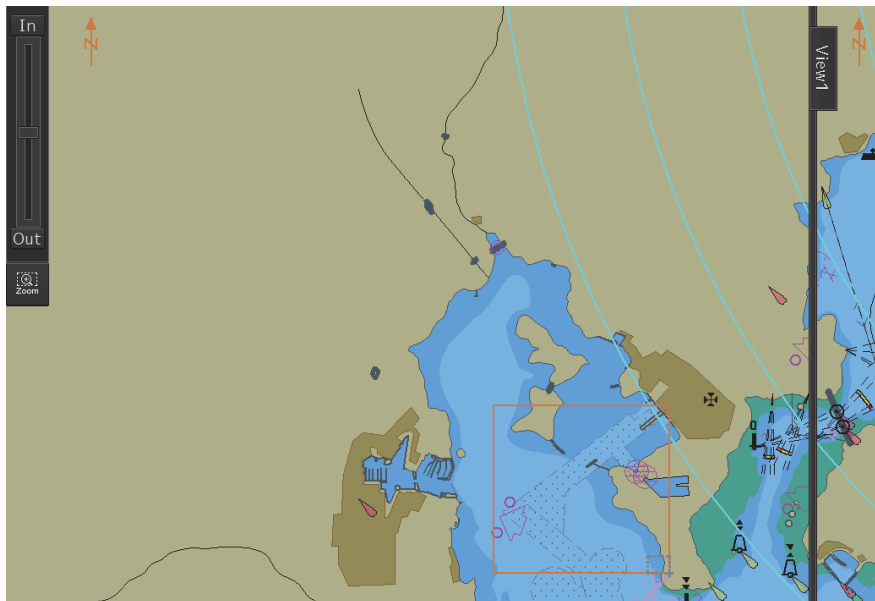

4 Click on.

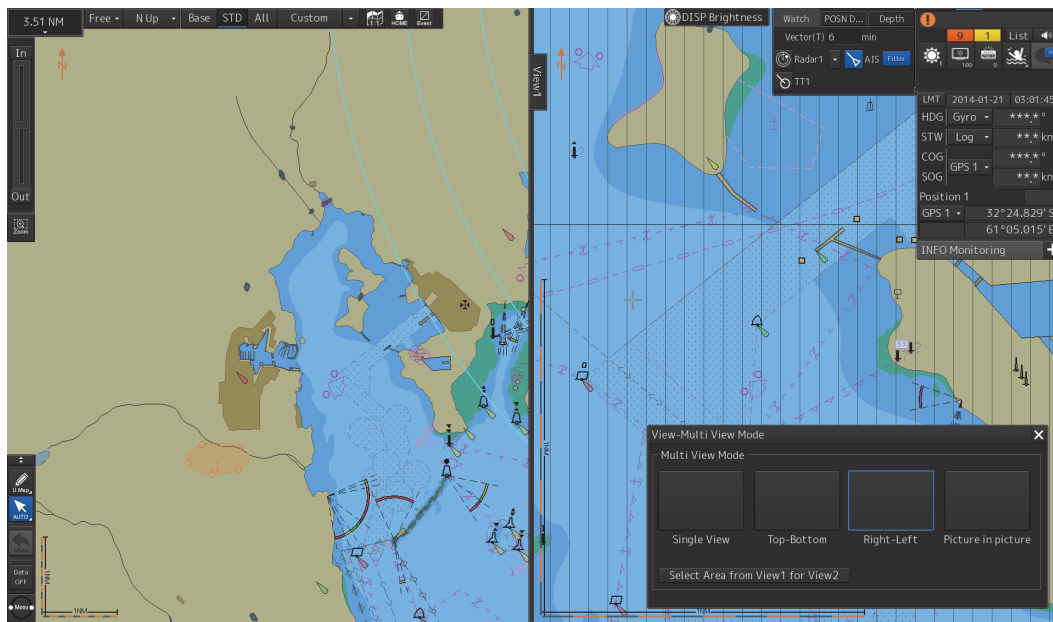

The specified range is displayed in View2.

The [Select Area from View1 for View2] button is displayed in normal video.

[Selecting a View]

Various operations can be performed in the selected view.

1 Click on the view you want to make active.

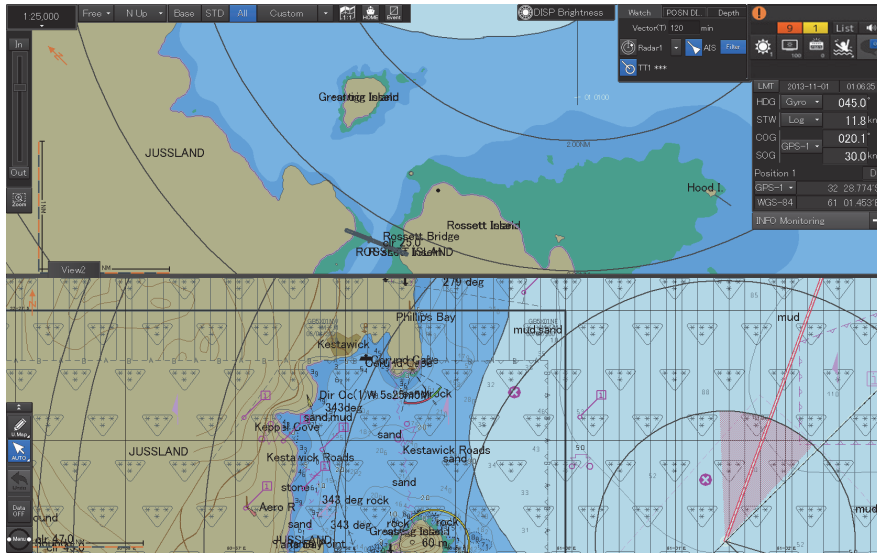

The clicked view becomes the active view.

Which view is active can be checked in active information display.

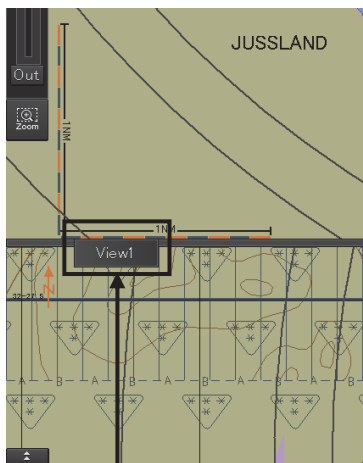

Active information display area

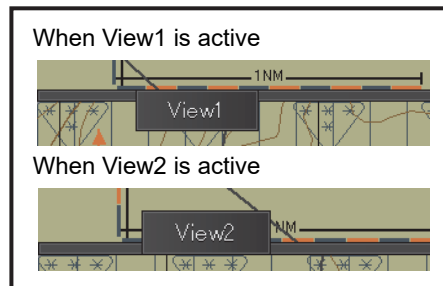

[Moving the Boundary Line of View]

When the view mode is either Top-Bottom or Right-Left, the boundary line of view can be moved.

- 1 To move the boundary line of view, click on the boundary line.**
- 2 When the cursor changes to the arrow shape shown below, move the boundary by dragging the cursor to the arrow directions.**



[Moving View2]

When the view mode is Picture in picture, the position of View2 can be moved.

- 1 Click on the title bar of View2**
- 2 When the cursor changes to the arrow shape shown below, move View2 by dragging the cursor to the arrow directions.**



6.11 Verifying Object Information (Pick Report Function)

Each of the objects on the chart has its own attributes (e.g. lighthouse, buoy, depth contour, land and river).

For example, if an object is a lighthouse, attributes such as lighting color and frequency can be read out. If the object is depth contour, the water depth can be read out.

Attribute information of these objects can be read and verified by using the pick report function.

The pick report displays the following information.

- S-57 chart
- C-MAP chart
- ARCS chart
- AIO
- Manual update

6.11.1 Pick Report of the S-57 chart

6.11.1.1 Displaying a Pick Report of the S-57 chart

- 1 Click the right button on the chart.

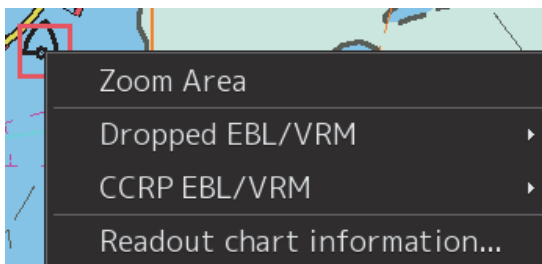

A pick mark and the context menu are displayed.

2 Click on [Cursor Pick] on the context menu.

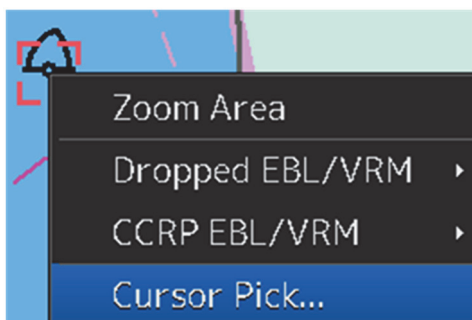

[Pick Report] dialog box appears.

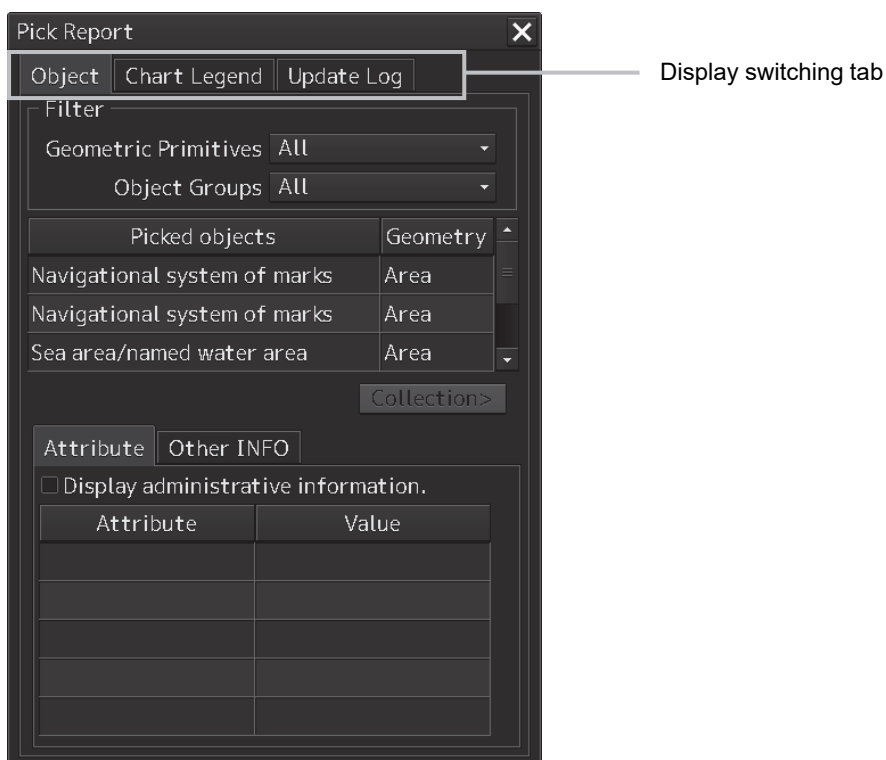

Display switching tab

This tab switches the information that is displayed. When the [Object] (Object Information) tab is clicked on, object information is displayed. When the [Chart Legend] tab is clicked on, chart information is displayed. When the [Update Log] tab is clicked on, chart update history is displayed.

6.11.1.2 Verifying Object Information

When the [Object] tab on the display switching tab is clicked on, object information is displayed.

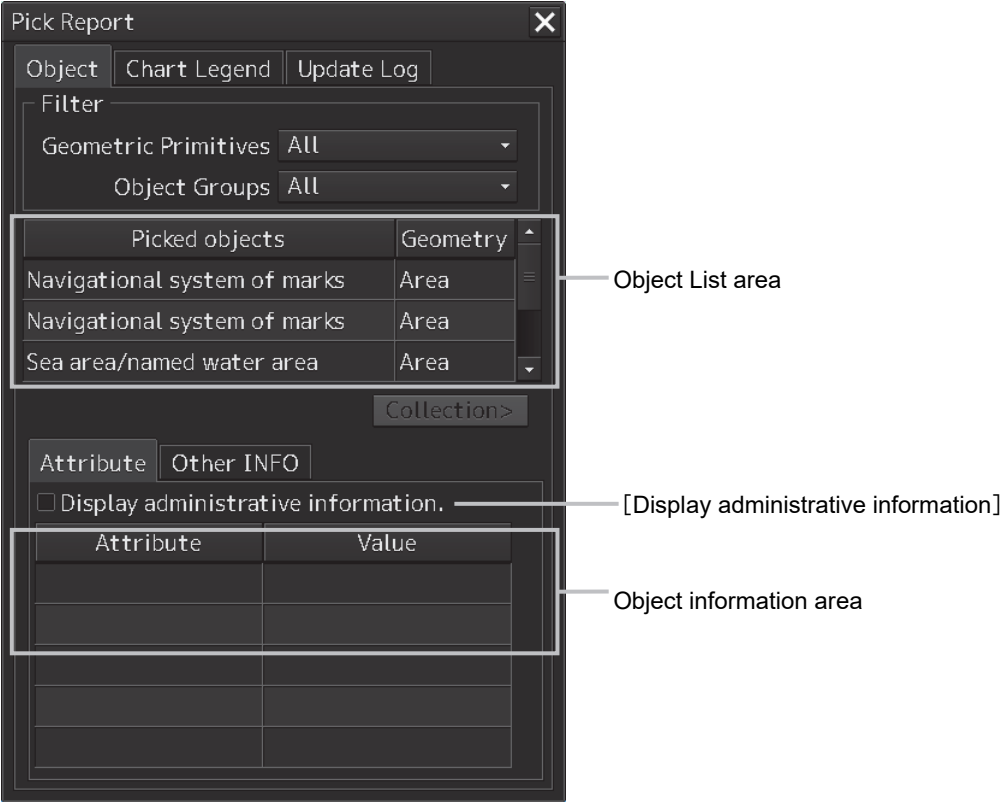

Object list area

The object within the pick cursor and its geometry are displayed in the object information area.

When an object is selected in the object list area, the selected object is displayed on the map in highlight mode in the case of the S-57 chart.

[Display administrative information]

When this item is selected, the attributes of the administrative information and the contents are displayed.

Object information area

Information (attributes) of the object that was selected from the object list is displayed.

The screenshot shows the 'Pick Report' dialog box with the following components:

- Object:** Chart Legend, Update Log
- Filter:** Geometric Primitives: All, Object Groups: All
- Picked objects:** A table with columns 'Picked objects' and 'Geometry'.

| Picked objects | Geometry |
|--------------------|----------|
| Landmark | Point |
| Radio station | Point |
| Magnetic variation | Area |
- Collection>** button
- Attribute:** Other INFO
- Display administrative information.
- Attribute table:**

| Attribute | Value |
|--------------------------|------------------------------|
| Function | light support |
| Height | 25m |
| Object name | Worm Head |
| Pictorial representation | GBTESTPC.TIF |

Labels for the first screenshot:

- [Attribute] (Attribute name) points to the 'Attribute' column header.
- [Value] (Attribute value) points to the 'Value' column header.
- Additional information file points to the [GBTESTPC.TIF](#) value.

This close-up shows the 'Attribute' and 'Value' columns. The attribute is 'Tidal stream - panel values' and the value is a button labeled 'View Table'.

Labels for the second screenshot:

- [Attribute] (Attribute name) points to the 'Attribute' column header.
- [Value] (Attribute value) points to the 'View Table' button.
- [View Table] button points to the 'View Table' button.

Displaying an additional information file

The additional information file on the object that was selected from the object list is displayed in [Value] in hyperlink format.

Additional information files include text files (extension.TXT) and image files (extension.TIF).

Example: In case of image file

[GBTESTPC.TIF](#)

When Hyperlink is clicked on, the additional information file is displayed in a separate dialog box.



[View Table] button

When the [View Table] button of [Value] is clicked on, the data is displayed in a separate dialog box in the format that is specified as the attribute.

| View Table | | | |
|-------------------------------|--------------|---------------|-----|
| Tidal Station Lookinghaven | | | |
| Tidal Station ID | | | 0 |
| Hours | Set [deg] | Drift [kn] | |
| Before High Water | -6 | 150 | 0.5 |
| | -5 | 190 | 1.2 |
| | -4 | 197 | 1.3 |
| | -3 | 205 | 1.2 |
| | -2 | 208 | 0.7 |
| | -1 | 260 | 0.4 |
| High Water | 0 | 355 | 0.8 |
| After High Water | +1 | 4 | 1.4 |
| | +2 | 20 | 1.8 |
| | +3 | 20 | 1.6 |
| | +4 | 25 | 1.2 |
| | +5 | 20 | 0.7 |
| | +6 | 0 | 0.0 |

Tidal stream - panel values

| View Table | | |
|------------|-----------|-------|
| | amplitude | phase |
| M2 | 0.962 | 165 |
| S2 | 0.361 | 243 |
| K1 | 1.223 | 097 |
| O1 | 0.875 | 143 |
| | | |
| | | |
| | | |
| | | |
| | | |
| | | |
| | | |
| | | |
| | | |

Tide - value of harmonic constituents

Accuracy information and symbol addition information of an object

When the [Other INFO] tab is clicked on, the accuracy information and symbol addition information of the object are displayed in the object information area.

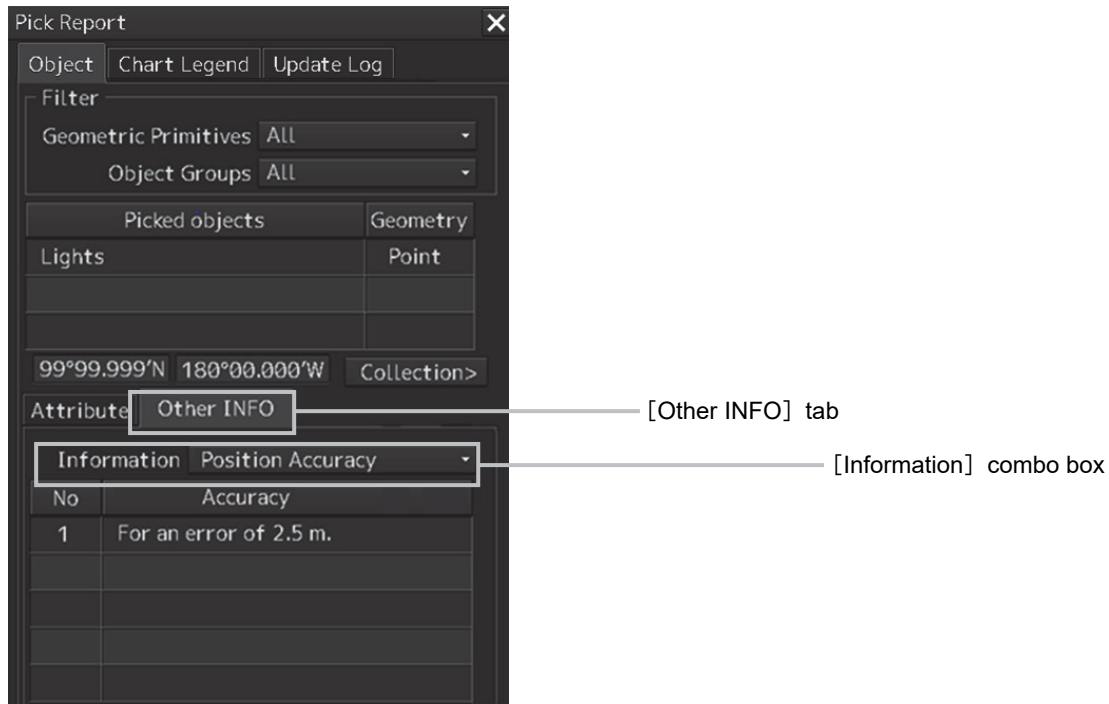

Each information item can be selected and displayed by using the [Information] combo box.

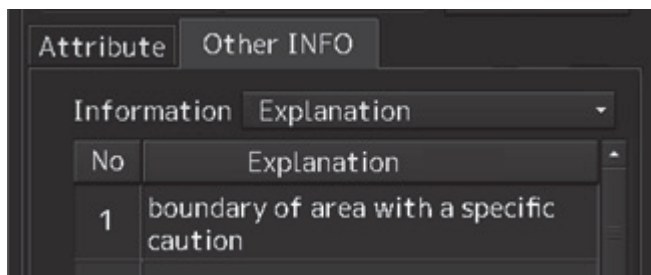
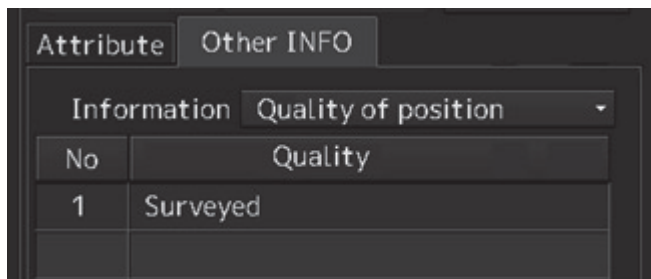

Coordinate display of an Unknown object

When an Unknown object is selected from the object selection list on the pick report screen, a text box is displayed indicating the coordinate of one representative point of Unknown objects.

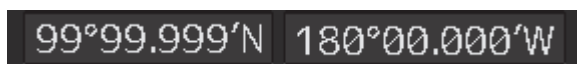

Pick report collection object display

The collection object that is linked to the object that is selected from Picked objects is displayed. Three collection object types are available: Aggregation, Association, and Stacked on/Stacked under. When the [Collection] button is clicked on, a Collection objects list is displayed. When [Back] button is clicked on after the list is displayed, the Picked Object list is displayed.

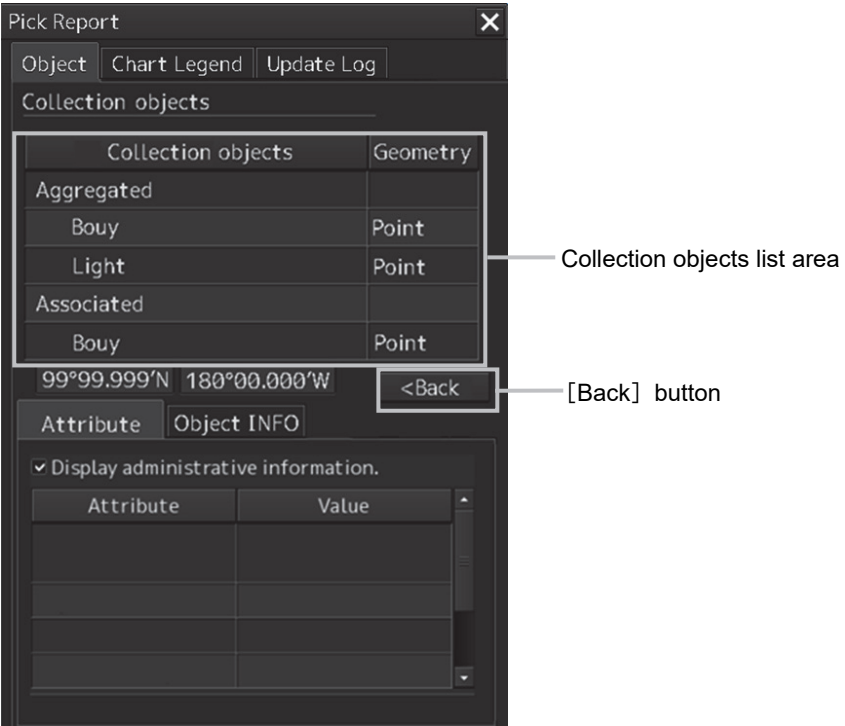
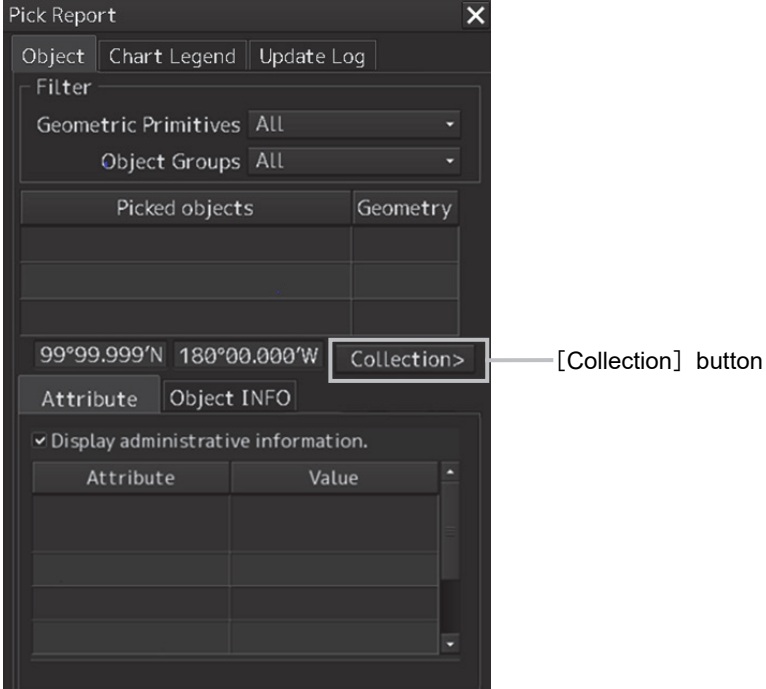

When there are no collection objects linked to the selected object, the Collection button is displayed as Disabled.

6.11.1.3 Verifying Chart Information

When the [Chart Legend] tab of the display switching tab is clicked on, chart information is displayed.

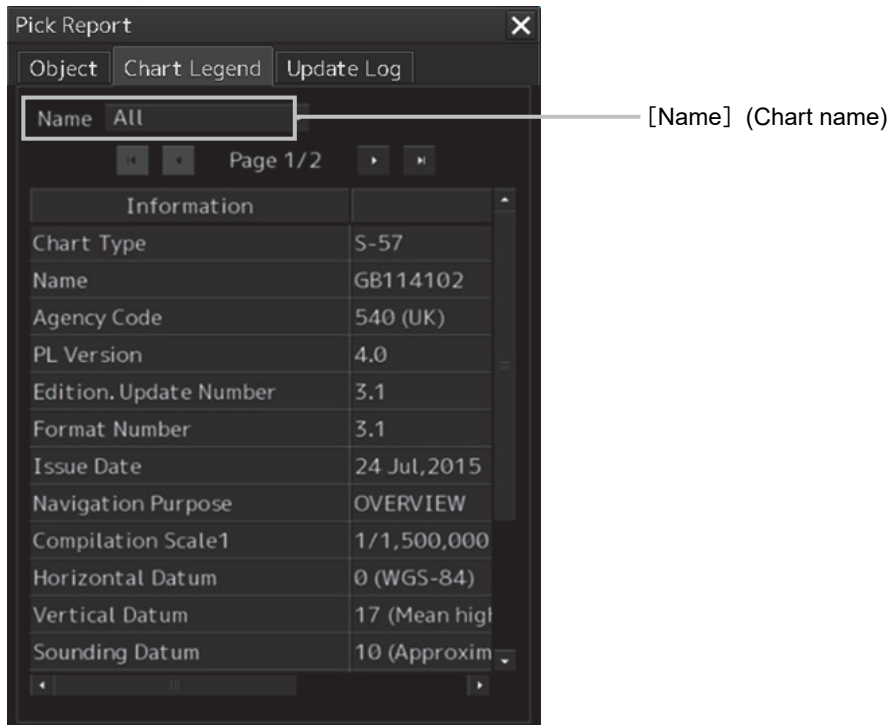

[Name] (Chart name)

When there are multiple charts on the selected chart position and a chart is selected from the list, the information about the chart is displayed. When [All] is selected from the list, information about all the charts is displayed.

Display of Zone Of Confidence

If Data Quality Indicator of the chart information is depth data, hyper link selection is displayed on the list. If hyper link is selected, the Zone of Confidence dialog is displayed.

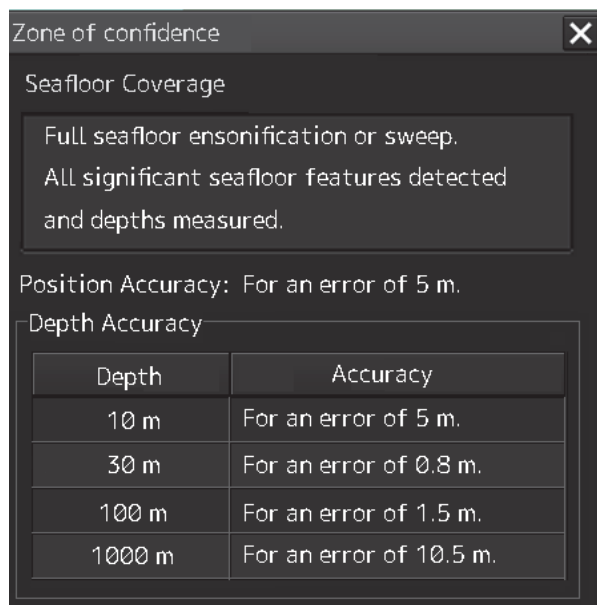

6.11.1.4 Verifying Chart Update History

When the [Update Log] tab of the display switching tab is clicked on, chart update history is displayed.

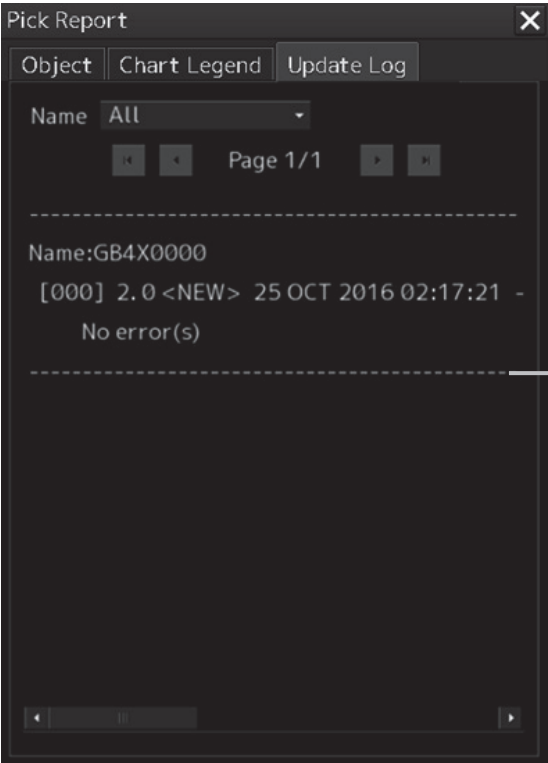

Separator of chart update history

If the chart update history consists of multiple pages and cannot be displayed on one page of the screen, drag the scroll bar to display the rest.

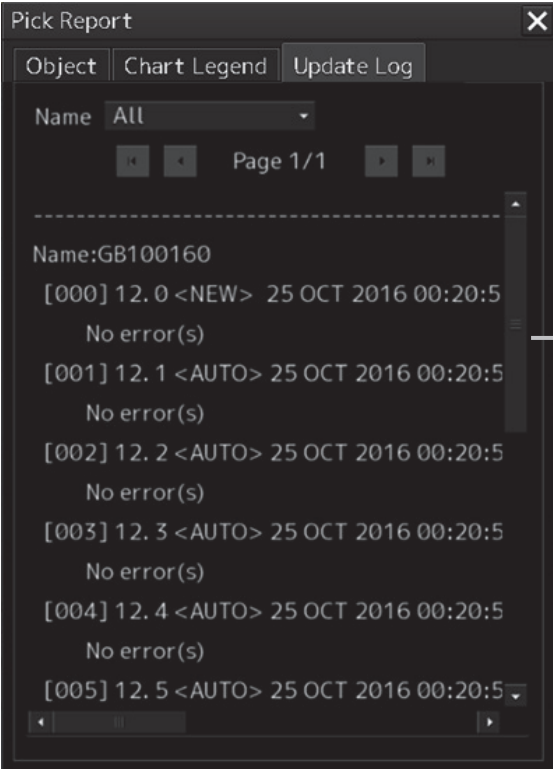

Scroll bar

6.11.2 Pick report of the C-MAP chart

The display procedure is the same as that of S-57.

In the case of C-MAP, the following contents are displayed from the [Update Log] (chart update history) tab.

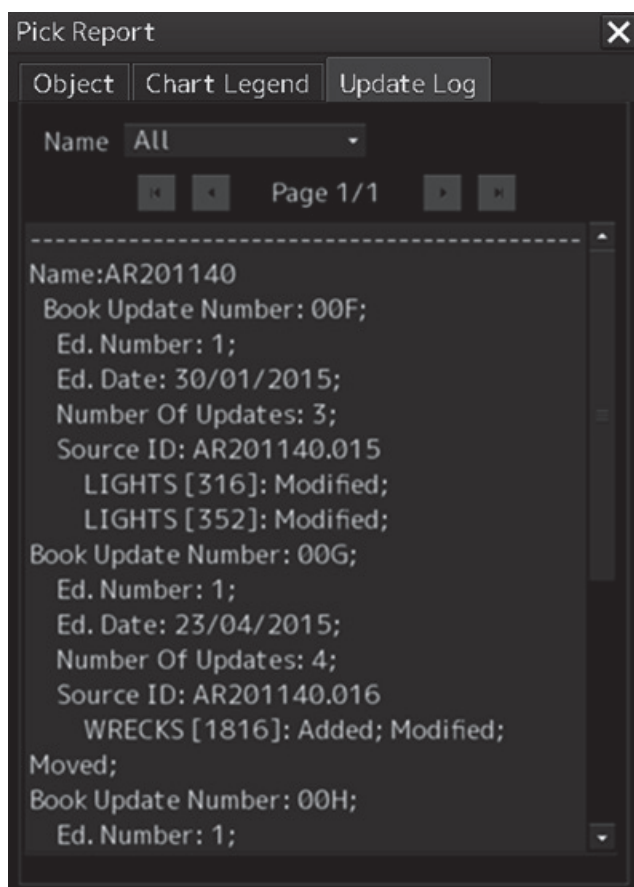

6.11.3 Pick report of the ARCS chart

The display method is the same as that of S-57.

In the case of ARCS, only the chart information area is displayed.

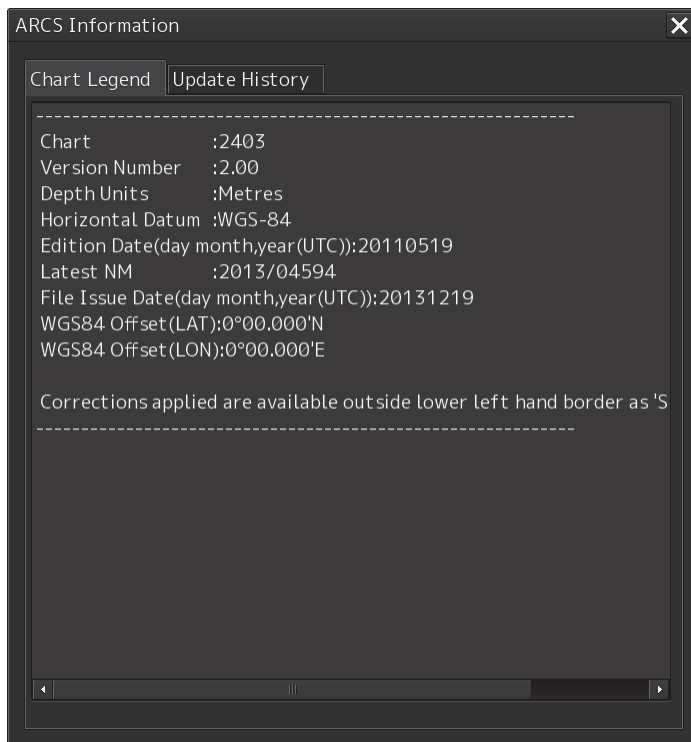

6.12 Marking the Position of Own Ship with an Event Mark

While sailing, you can mark the position of own ship on the chart with an event mark.

- 1 Click on the [Event] button in Chart Information Area.



An event mark is marked to the position of own ship and the [Property] dialog box of event marks appears.

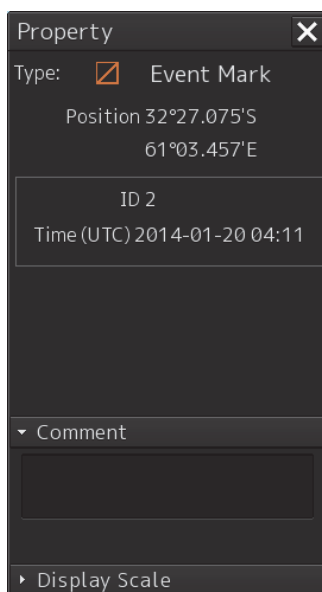
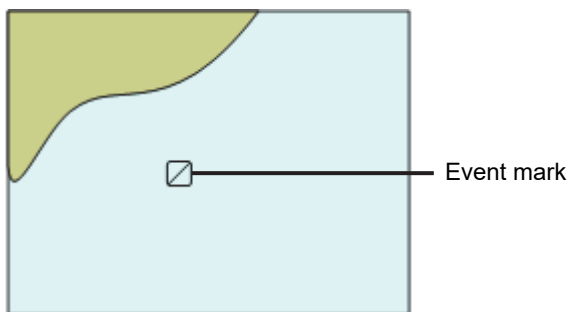

The display position, ID, and date and time of creation of the event mark are displayed in the [Property] dialog box.

Enter any desired comment in the [Comment] input box.

[Deleting the Event Mark]

The event mark can be deleted by either of the following methods.

- Right-click on the event mark and click on [Delete this object] on the Context menu that appears.
- Click on the event mark when in the Delete mode.

6.13 Displaying Radar Images on a Chart by Overlaying (Option)

Note

In case of JAN-7201S/9201S, overlay function is not available by function restriction.

Radar images can be displayed by overlaying on the chart.

Note

- To perform overlay display of radar images, the radar function must be installed and radar images must be received from the radar system.
*The radar function is installed as standard on the ECDIS. It is an optional function for machines dedicated to the ECDIS.
- If the radar system displays a short-range image and a long-range image on the ECDIS at the same time, the radar image on the ECDIS may be distorted.
- While the radar image is displayed, the display range can be changed in 11 steps (0.125/0.25/0.5/0.75/1.5/3/6/12/24/48/96 NM).
- In the case of ARCS charts, the display range varies with the chart to be displayed. If a range over 120 NM is selected, radar image display automatically turns off.
- The screen display color will automatically change to [Day3] when RADAR Overlay is turned on. (When the screen display color is Dusk/Night, automatic switching does not occur.)
- When Multi-view is used, images cannot be displayed on View2.

6.13.1 Turning On/Off overlay display

Note

In case of JAN-7201S/9201S, overlay function is not available by function restriction.

- 1 Click on the [Menu] button on the left toolbar.
The menu is displayed.
- 2 Select [View] - [Options] - [RADAR] on the menu.

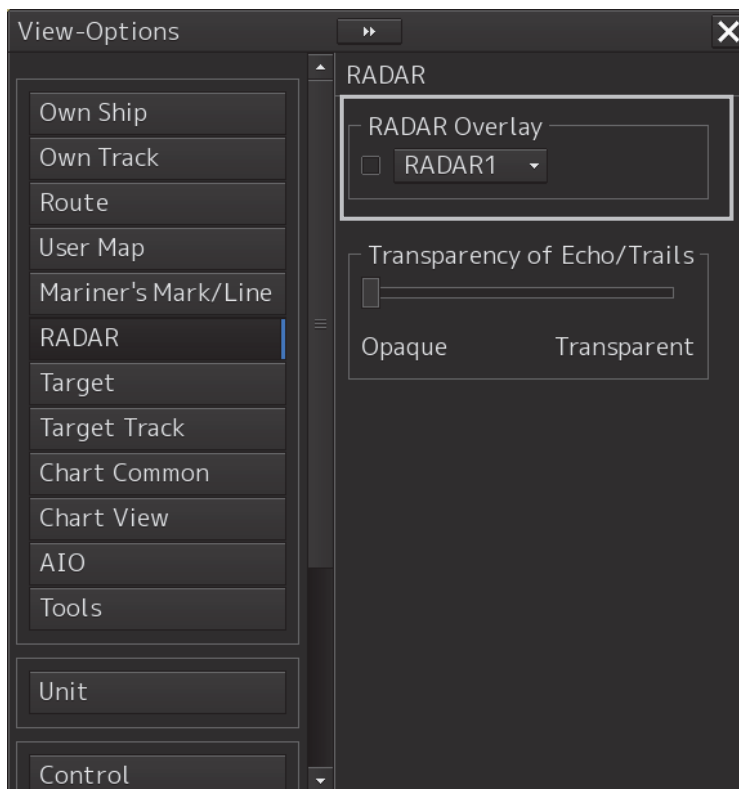

- 3 Select [RADAR Overlay].
Radar overlay display is set to On.
- 4 Select a radar system to be used from the pull-down menu.

Memo

- When multiple radar systems are available, click the [RADAR Overlay] combo box and then select the radar image to be used from the pull-down menu that appears. (Radar images can be selected from the maximum of 8 systems, [RADAR1] to [RADAR8].)
- Even if the connection between this equipment and the radar system is not set or the connection setting is cancelled, reconnection is set automatically. As a result, the overlay display of the radar image is continued.

[Transparency Setting of Echo/Trails]

Transparency can be set up by clicking the [Transparency of Echo/Trails] slider handle to right and left.

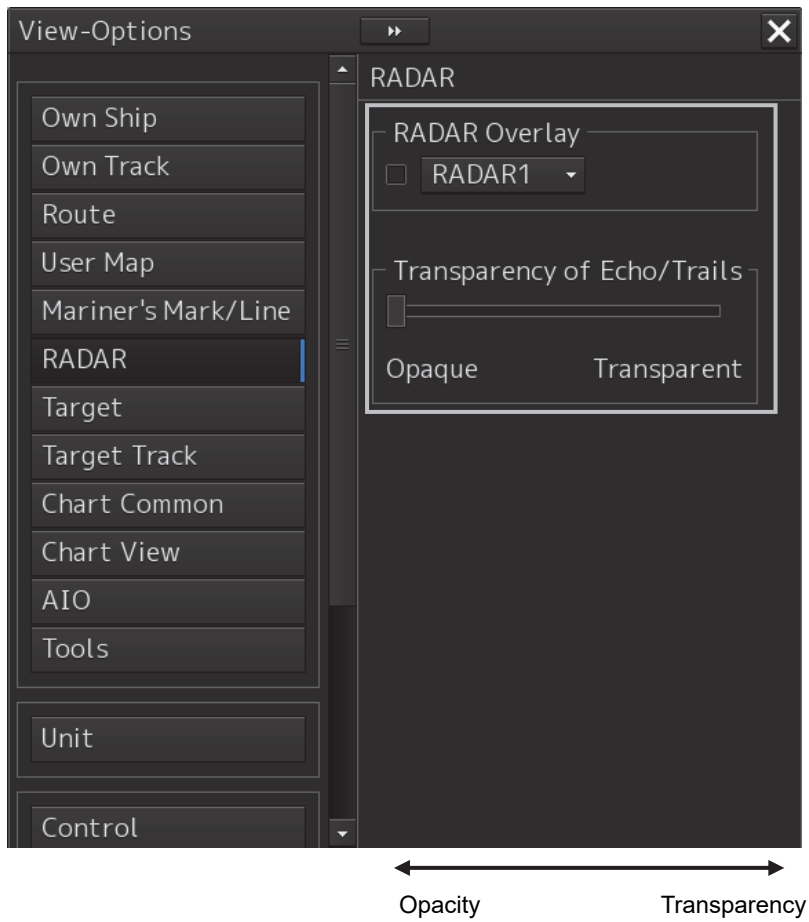

6.13.2 Turning On/Off range ring display

Note

In case of JAN-7201S/9201S, overlay function is not available by function restriction.

- 1 Click on the [Menu] button on the left toolbar.
The menu is displayed.
- 2 Select [View] - [Options] - [Tools] on the menu.

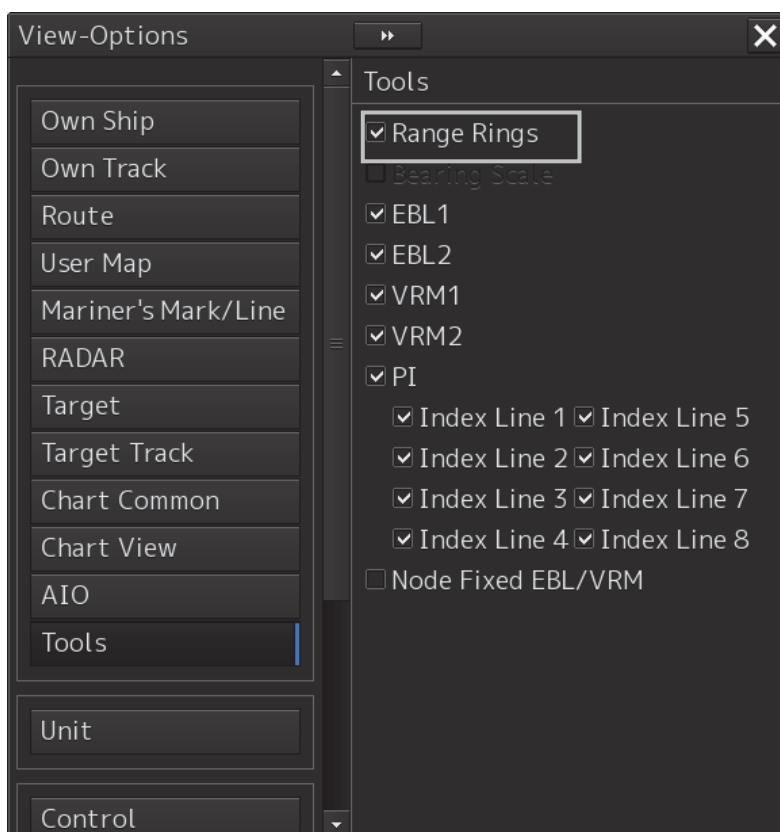

- 3 To show range rings, select [Range Rings].
To hide range rings, clear it.

6.13.3 Turning On/Off bearing scale

Note

In case of JAN-7201S/9201S, overlay function is not available by function restriction.

- 1 Click on the [Menu] button on the left toolbar.
The menu is displayed.
- 2 Select [View] - [Options] - [Tools] on the menu.

6

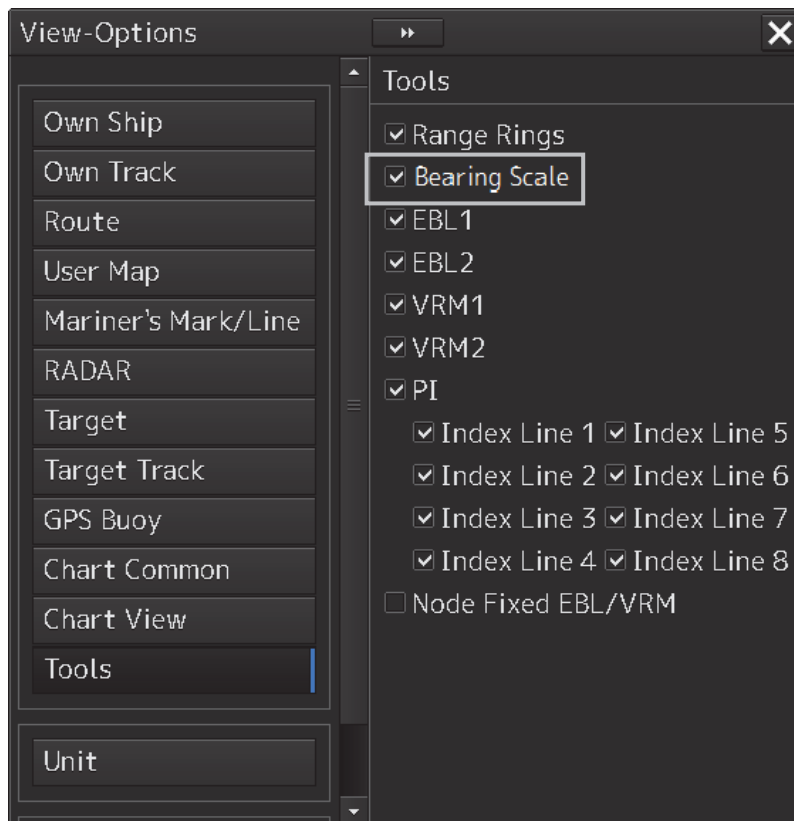

- 3 To show a bearing scale, check [Bearing Scale].
To hide a bearing scale, clear it.

6.13.4 Radar image adjustment

Note

In case of JAN-7201S/9201S, overlay function is not available by function restriction.

Radar images can be adjusted using the [RAIN], [SEA] and [GAIN] dials on the keyboard operation unit.

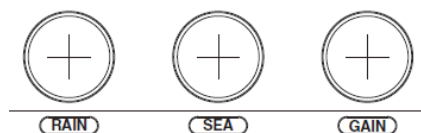

[RAIN] dial: Suppressing rain and snow clutter

The [RAIN] dial suppresses clutter caused by rain and snow. Turning the [RAIN] dial to the right enhances the contours of targets that are hidden in images of rain and snow. Take care not to over-adjust this dial. Otherwise, you may miss small targets. This dial also reduces sea clutter. So, using both the [RAIN] and [SEA] dials is more effective. Normally, keep this dial turned as far as possible to the left.

[SEA] dial: Suppressing sea clutter

The [SEA] dial lowers the gain at a short range to reduce sea clutter. Turning the [SEA] dial to the right increases the effect of suppressing sea clutter. Take care not to over-adjust this dial. Otherwise, you may miss small targets like buoys and small boats.

[GAIN] dial: Adjusting sensitivity

The [GAIN] dial adjusts the gain of RADAR echo. Turning the [GAIN] dial to the right increases the gain and widens the range in which RADAR echo can be observed.

Take care not to over-adjust this dial, as reception noise on screen increases. This worsens the contrast and makes it more difficult to tell the difference between targets and RADAR echo. Alternatively, turning the [GAIN] dial to the left to view at a short range or screens containing closely packed targets, decreases the gain making targets easier to view. Take care not to over-adjust this dial. Otherwise, you may miss small targets.

Memo

If the keyboard operation unit is not available, the radar image can be adjusted using [Rain], [Sea] or [Gain] slider in the setting dialog of [Settings]- [Signal Process (Basic)] on the menu.

The [Signal Process (Basic)] setting dialog can also be displayed by operating the [RAIN], [SEA], or [GAIN] dials on the keyboard operation unit.

When one of the dials is held down (for 2 seconds or more) at operation termination, the setting dialog is closed.

For the details of the [Signal Process(Basic)] setting dialog, refer to "16.2 Basic setting of radar signal processing".

6.14 Setting a true bearing

When a gyro signal is input by using GYRO I/F, sometimes the true bearing value indicated by the master gyro and the true bearing value indicated by this equipment do not match.

In this case, set the true bearing value of this equipment to the value of the master gyro by using the following procedure.

- 1 Click on the [Menu] button on the left toolbar.**

The menu is displayed.

- 2 Click on [Settings] - [General] on the menu.**

The [General] dialog is displayed.

- 3 Click on the [Gyro Setting] input box.**



- 4 Enter the master gyro value through the software keyboard.**

6.15 Setting an own ship's speed

6.15.1 Switching an own ship's speed sensor

- 1 Click on the STW Source combo box of the own ship's information

| | | |
|------------|------------|--------------|
| LMT | 2014-01-17 | 19:25:00 |
| HDG | Gyro ▾ | 045.0° |
| STW | Log ▾ | *.* kn |
| COG | | 020.1° |
| SOG | GPS 1 ▾ | 30.0 kn |
| Position 1 | | DGPS |
| GPS 1 ▾ | | 29°21.642' S |
| WGS-84 | | 64°39.622' E |

- 2 Select a sensor source in the [STW] combo box. Any of the following sensor sources can be selected.

MAN

Logx ("x" indicates the equipment number)

When [Menu] is selected, the [Sensor Selection/Status] dialog is displayed.

When [MAN] (Manual) is selected, a speed through water can be input in the [Sensor Selection/Status] dialog.



- When using 1-axis log, heading speed component can be detected, but transverse speed component cannot be detected. Then leeway effect (component drifted by wind) cannot be detected.
- When using 2-axes log, its accuracy in shallow waters may be deteriorated, and its speed in deep sea areas may be unable to be detected.
- When using a GPS, COG accuracy is less than $\pm 3^\circ$ at speed: from 1kn to 17kn, and is less than $\pm 1^\circ$ at speed: more than 17kn.

6.15.2 Entering the ship's heading/own ship's speed manually

When the device (example: LOG) that is connected to this equipment fails to function, the target tracking device and true motion display can be used by entering the ship's heading/own ship's speed manually by using the following procedure.

- 1 Select [Menu] from the corresponding combo box.



The [Sensor Selection/Status] dialog box appears.

- 2 To enter the ship's heading manually, select [Manual] from the [Heading] combo box. To enter the ship's own speed manually, select [Manual] from the [STW] combo box.
- 3 Click on the input combo box.

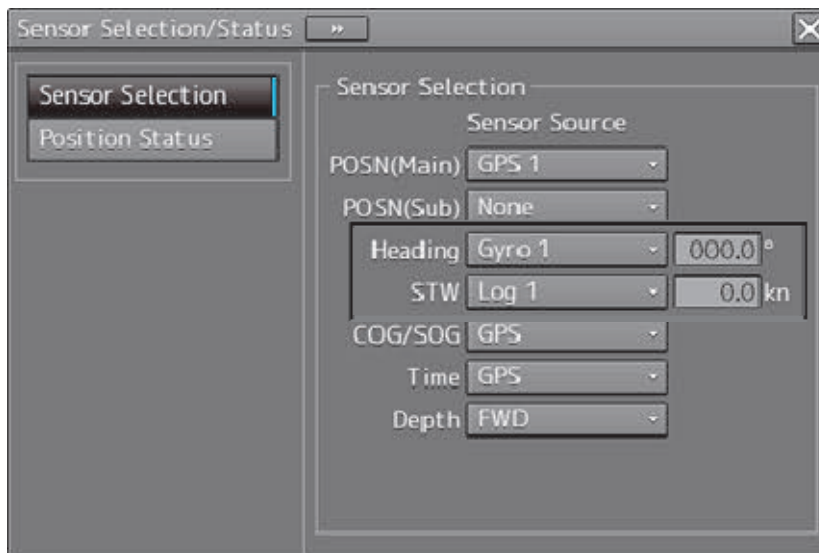

- 4 Enter numeric values through the software keyboard.



Section 7 Route Planning

⚠ CAUTION



Edit the navigation route according to the world geodetic system (WGS-84).
If you use the navigation route edited by a geodetic system other than the world geodetic system, an accident may occur.

The Route Planning function creates and edits a route of a ship in advance. A route comprises WPTs (waypoints) from the starting point to the arrival point and the straight lines (legs) that connect the WPTs.

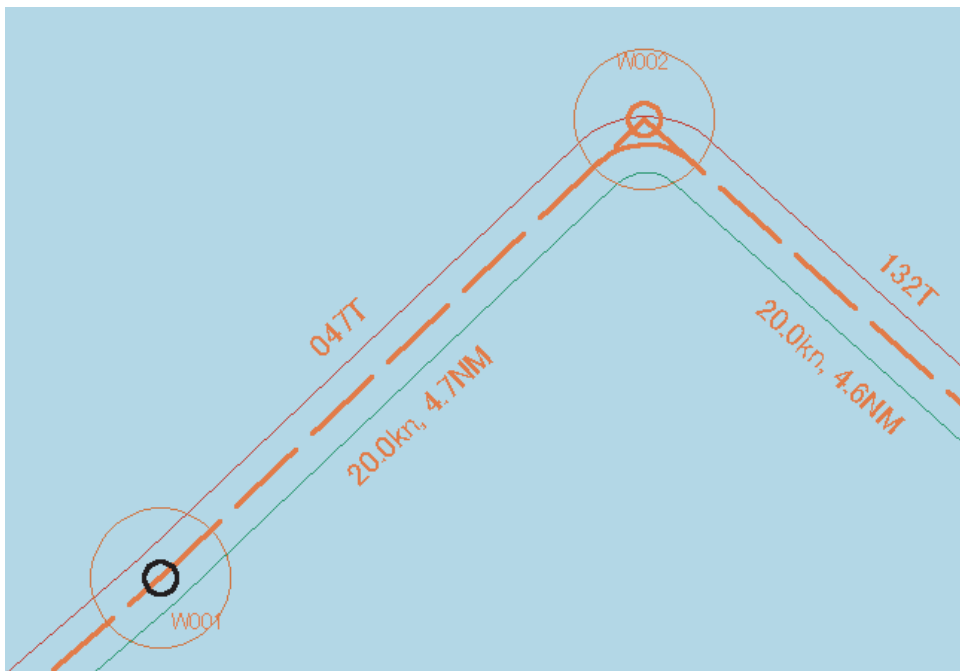

Route Planning Example

7.1 Overview of the Route Planning Function

Table editing function

This function enables creation of a route in table format by using the [Route Planning] dialog box.

A route is created by entering each WPT into the WPT list.

For the details of route planning with table editing, refer to "7.6 Planning a Route by Using Table Editing".

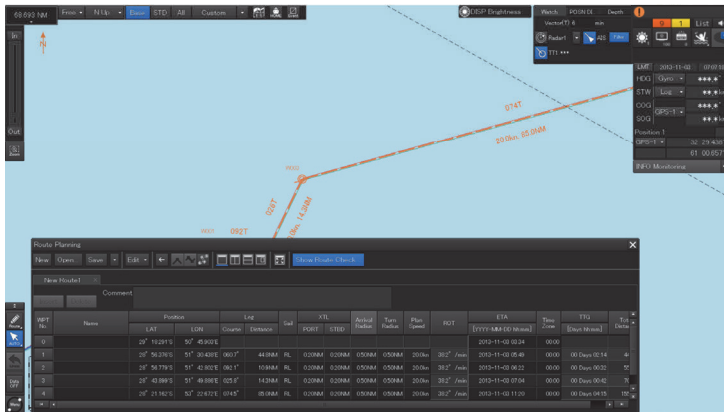

Graphic editing function

This function enables creating a route on a chart.

A route plan is created by adding a WPT on a chart.

For the details of route planning with graphic editing, refer to "7.7 Planning a New Route by Graphic Editing".

Route planning safety checking function

This function checks the safety of the planned route.

For the details, refer to "7.9.1 Checking a route based on the safety standards".

Route planning limit checking function

This function checks whether the planned route does not violate the pre-defined limit.

For the details, refer to "7.9.2 Checking a route based on the limits".

Navigation calculating function

This function supports the calculation of distance and bearing that are required for navigation.

For the details, refer to "7.10 Navigation Calculation Function".

Import/Export function

This function imports/exports a route file.

For the details, refer to "7.11 Importing/Exporting a Route File".

Note

- When a route is created exceeding the limit value, an error message is displayed and Route planning operation stops.
- If the distance between WPTs exceeds 150° in longitude, the route cannot be created.

7.2 Setting Route Display

Before creating a route, set route display (display/hide of the route information to be displayed on the screen) at route setting.

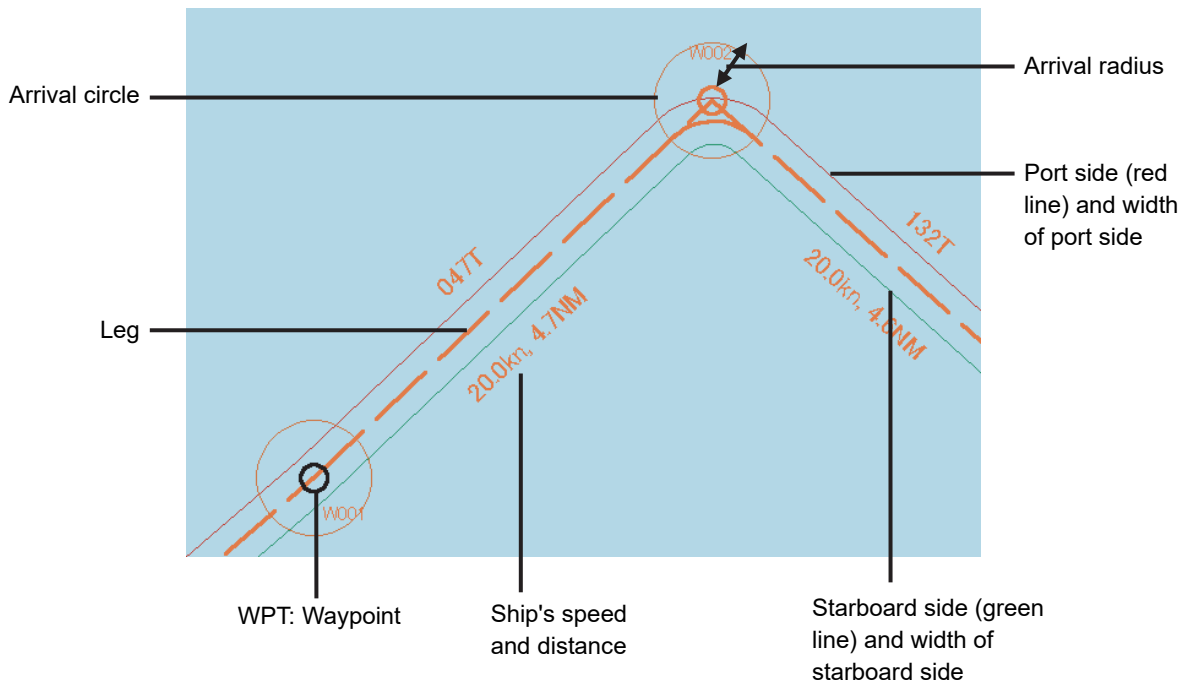

Use the following two dialogs for the setting.

7.2.1 Setting [Route] after selecting [View] - [Options] on the menu

- 1** Click on the [Menu] button on the left toolbar.
The menu is displayed.
- 2** Click on the [View] - [Options] - [Route] on the menu.
The "Route" setting screen is displayed.

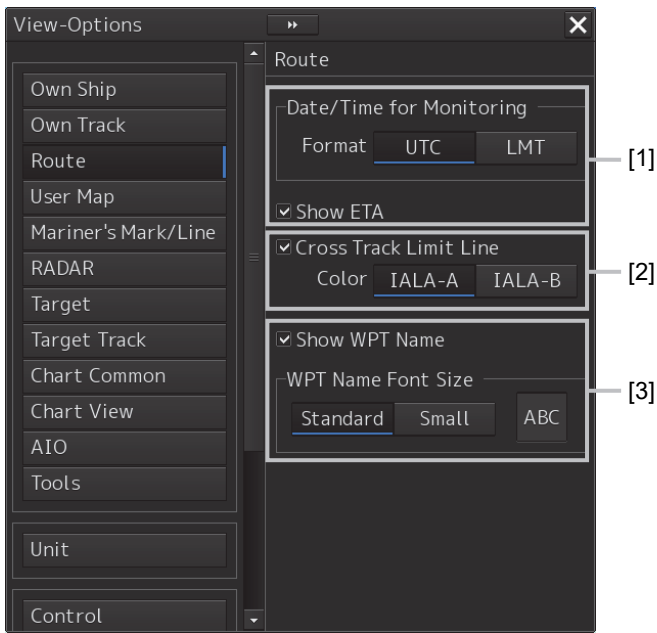

[1] [Show ETA]

By selecting the [ETA] check box, the display of the ETA (estimated time of arrival to WPT) becomes effective at route monitoring.

When [UTC] from [Format] is clicked, UTC is displayed and when [LMT] is clicked, LMT is displayed.

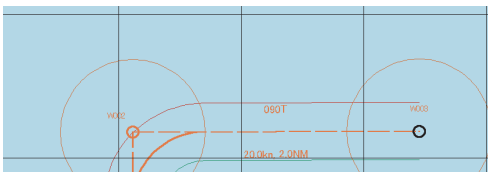

Not selecting the [ETA] check box

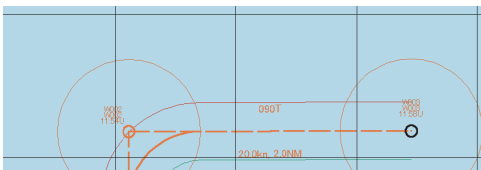

Selecting the [Show ETA] check box, and clicking [UTC] as the arrival time display format

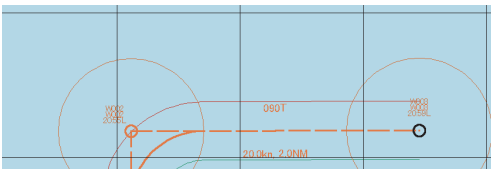

Selecting the [Show ETA] check box, and clicking [LMT] as the arrival time display format

[2] [XTD Limit Line]

When this item is selected, a cross track limit line is displayed.

When this item is selected, the line color can be set.

When [IALA-A] is clicked on, the starboard side is displayed in green and the port side is displayed in red.

When [IALA-B] is clicked on, the starboard side is displayed in red and the port side is displayed in green.

[3] [Show WPT Name] (Show comment)

When this item is selected, a comment is displayed near the WPT.

When this item is selected, the character size of the comment can be set.

When [Standard] is clicked on, the comment is displayed in the standard character size.

When [Small] is clicked on, the comment is displayed in the character size smaller than the standard size.

[4] [Alternate Route] (Change Color)

When [Blue] is clicked on, the route is displayed in blue.

When [Orange] is clicked on, the route is displayed in orange.

7.2.2 Setting [Settings] - [Route] on the menu

- 1 Click on the [Menu] button on the left toolbar.**

The menu is displayed.

- 2 Click on the [Settings] - [Route] on the menu.**

The [Route] dialog is displayed.

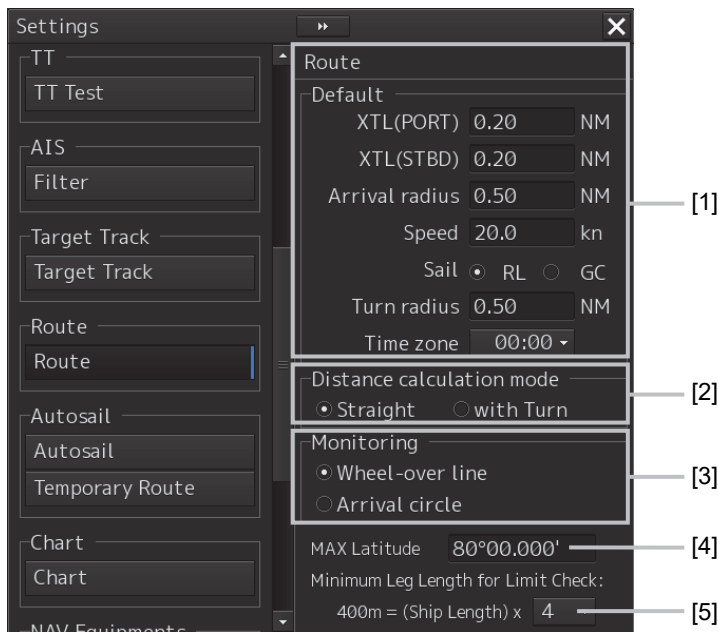

[1] [Default] (Factory settings)

Set factory settings of the route display that is created at route planning.

[XTD(PORT)]:

Set a port side cross track limit.

[XTD(STBD)]:

Set a starboard side cross track limit.

[Arrival radius]:

Set an arrival radius of WPT.

[Speed]:

Set a planned ship's speed.

[Sail]:

Select sailing mode.

- When [RL] is selected, the mode is set to Rhumb Line.

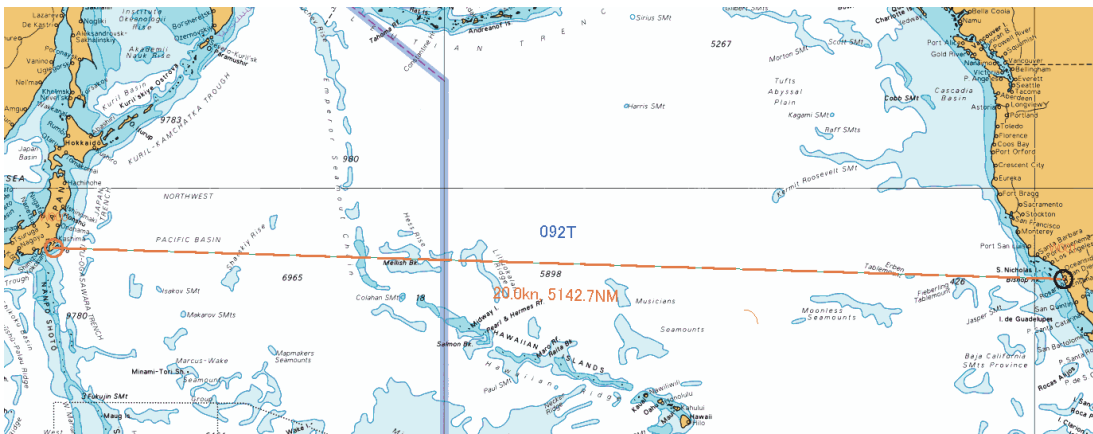

Display Example

- When [GC] is selected, the mode is set to Great Circle.

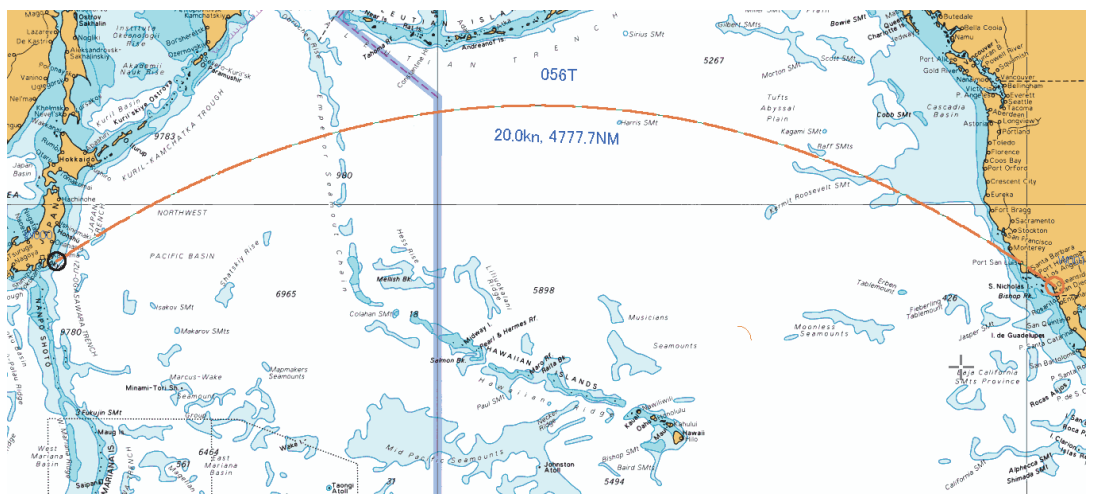

Display Example

[Turn radius]:

Set a turning radius.

[Time zone] combo box:

Set a time zone.

[2] [Distance calculation mode]

Set a method for calculating a distance between WPTs.

When [Straight] is selected, a distance between WPTs is calculated with a straight line



When [with Turn] is selected, a distance between WPTs is calculated based on the expected route.

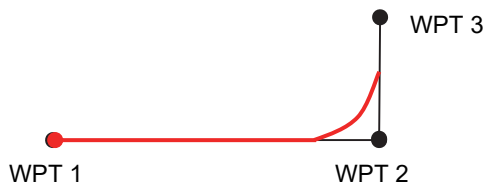

[3] [Monitoring]

Set a route monitoring method.

When [Wheel-over line] (steering line) is selected, monitoring is performed by using Wheel-over line (WOL) along each WPT.

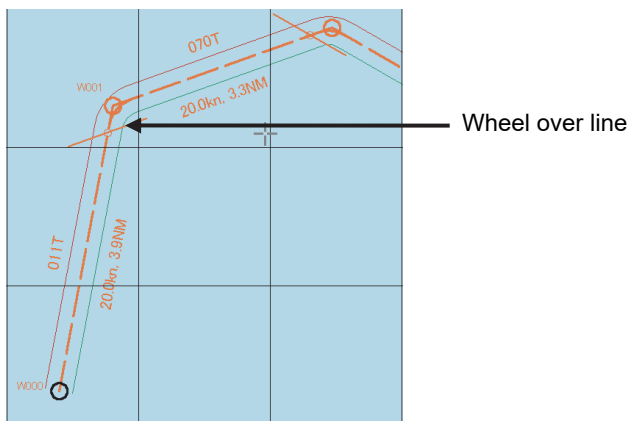

When [Arrival circle] is selected, monitoring is performed by using the arrival circle along each WPT.

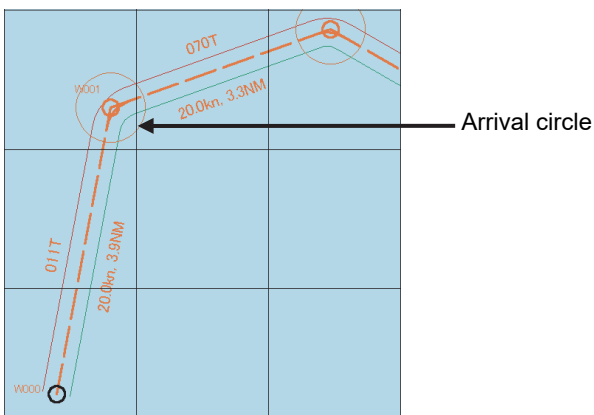

[4] [MAX Latitude]

Set maximum latitude.

A WPT can no longer be entered in a latitude higher than the latitude that has been set up.

If sailing is [GC], it is possible to create a route by automatically adding WPTs so as not to exceed the maximum latitude in the case of a route in which part of the leg passes a latitude higher than the maximum latitude.

If the maximum latitude is 60° or higher, a route can be created even if the GC leg exceeds 60°.

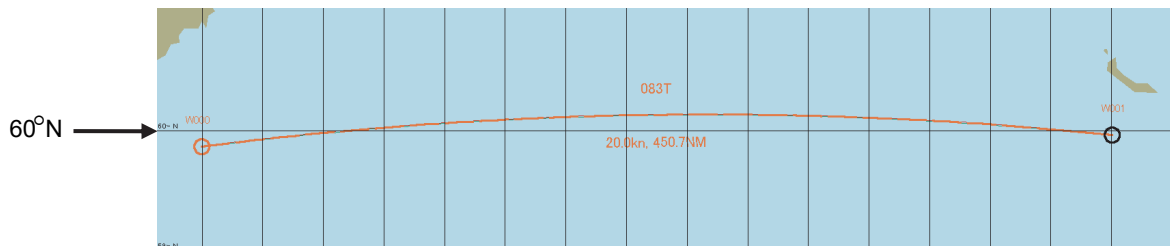

If the GC leg exceeds 60° when the maximum latitude is 60°, WPTs are automatically added and the route is adjusted so as not to exceed 60°.

WPTs (W001 and W002) in this example are added so as not to exceed the maximum latitude (60°).
The segment between W001 and W002 becomes an RL leg.

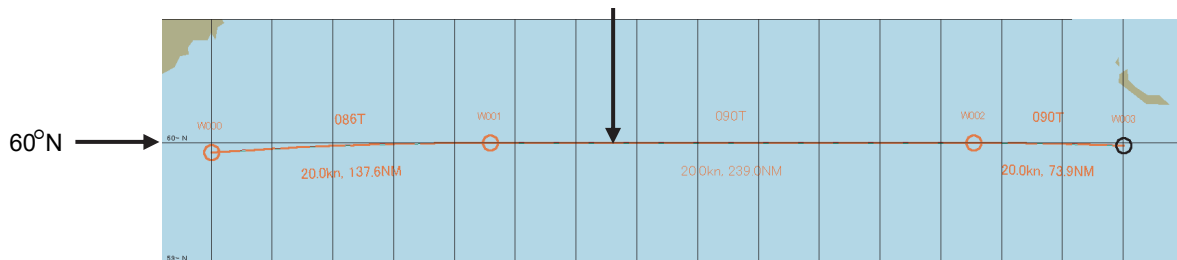

Note:

- A route cannot be created with a leg of 150° or higher in the longitudinal direction.
- Create a user map at latitude 84° or lower.

[5] [Minimum Leg Length for Limit Check] combo box

Select a multiplier for determining the "minimum leg length" that is used for limit check from 1, 2, 4, 6, or 8.

Calculation expression: Minimum leg length = (Hull length) x multiplier

7.3 Starting and Ending the [Route Planning] Dialog Box

Plan a route on the [Route Planning] dialog box. The procedures for starting and ending the [Route Planning] dialog box are as follows.

7.3.1 Starting the [Route Planning] dialog box

- 1 Click on the [Menu] button on the left toolbar.
The top menu is displayed.
- 2 Click on the [Route Planning] button on the top menu.
The [Route Planning] dialog box appears on the screen.

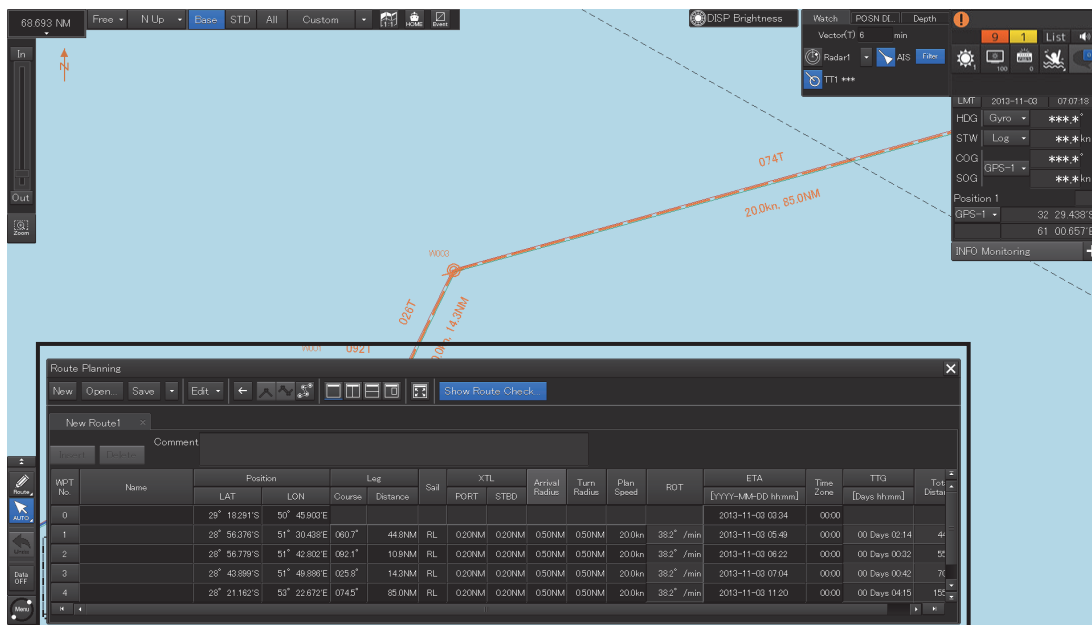

Display Example

The width of the dialog box varies according to the screen size.

7.3.2 Ending the [Route Planning] dialog box

- 1 Click on the [X] button on the dialog box.

7.4 Name and Function of Each Section of the [Route Planning] dialog Box

The [Route Planning] dialog box comprises as below.

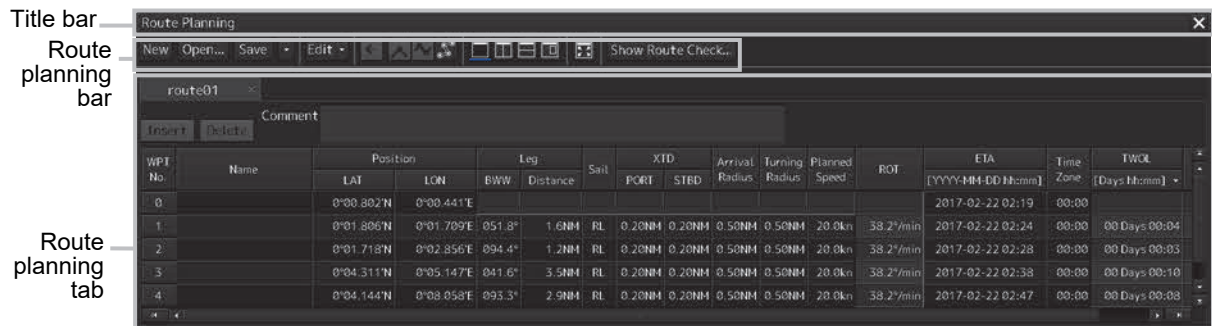

| Name | Function |
|--------------------|---|
| Title bar | Displays the menu title, "Route Planning". |
| Route Planning bar | Route planning tools are assigned (Refer to "7.4.1 Route Planning bar".). |
| Route planning tab | Displays the file name and route data of the route file that is being created (Refer to "7.4.2 Route planning tab".). |

7.4.1 Route Planning bar

The Route Planning bar comprises the following tools.

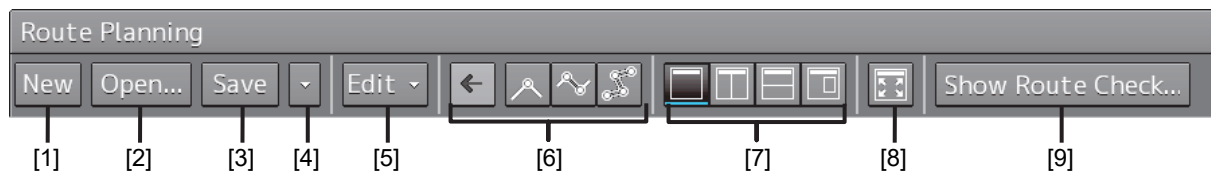

[1] [New] button

When this button is clicked on, a new route planning tab is added to the dialog box, enabling creation of a new route file.

Note

Up to four route files can be opened concurrently. If four files have already been opened, the [New] button is disabled. To create a new route file, close one or more of the files that are opened and click on the [New] button.

[2] [Open...] button

When this button is clicked on, the [File Operations] (Open a file) dialog box appears and a required file can be selected and opened from the route list of the files that have been saved.

Note
Up to four route files can be opened concurrently. If four files have already been opened, the [Open] button is disabled. To open from the saving list, close one or more of the files that are opened and click on the [Open] button.

[3] [Save] button

When the [Save] button is clicked on, the route file is saved.

For the details, refer to "7.5 Saving a Route".

[4] Route planning menu button

When this button is clicked on, the route planning menu is displayed.

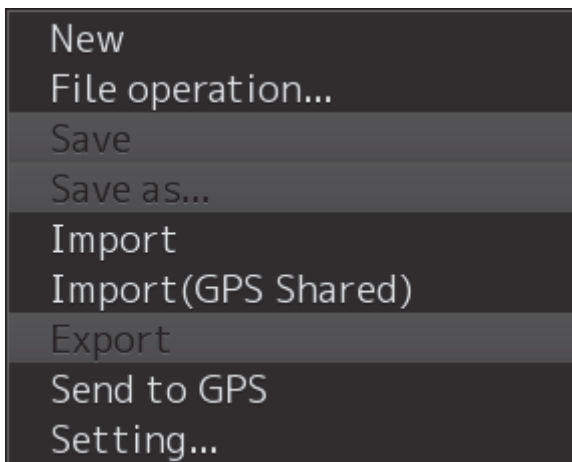

The following operations can be performed by using the route planning menu.

| Menu button name | Function | Related section |
|--|---|--|
| [New] | Creates a new route file. | 7.6.2 Creating a new route file by table editing 7.7.2 Creating a new route file by graphic editing |
| [File operation...] | Displays the [File operation] dialog box. | 7.6.4 Editing a route by table editing |
| [Save] (overwrite save) | Saves a route file by overwriting. | 7.5 Saving a Route |
| [Save as...] | Saves a route file by naming the file. | 7.5 Saving a Route |
| [Import] | Displays the [Import] dialog box. | 7.11.1 Importing a route file |
| [Import](GPS Shared) (import from GPS) | Displays the [Import(GPS Shared)] dialog box. | Instruction Manual <Function 2>, 1.6 Importing the Route File That Is Received from GPS |
| [Export] | Displays the [Export] dialog box. | 7.11.2 Exporting a route file |

| Menu button name | Function | Related section |
|---------------------------------|--|---|
| Send to GPS (Export for GPS) | Displays the [Send to GPS] dialog. | Instruction Manual <Function 2>, 1.6.1 Transmitting a route file to GPS |
| [Setting...] | Displays the [Route] dialog box for setting initial values of the route at route planning. | 7.2.2 Setting [Settings] - [Route] on the menu |

[5] [Edit] button

When this button is clicked on, the Edit menu is displayed.

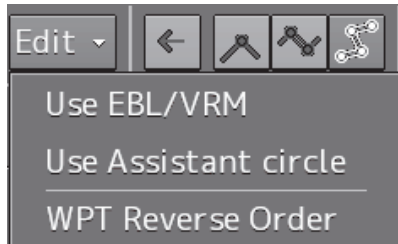

The following operations can be performed by using the Edit menu.

| Menu button name | Function | Related section |
|------------------------|---|---|
| [Use EBL/VRM] | When this item is selected by clicking on the item, the EBL/VRM mode that enables creation of a route by using EBL and VRM becomes available. When the item is clicked on again, the check mark is cleared and EBL/VRM mode is cancelled. | 7.7.2.1 Creating a route by using EBL/VRM |
| [Use Assistant circle] | When this item is selected by clicking on the item, the Use Assistant circle mode that enables creation of a route by using an assistant circle (supplementary line) becomes available. When the item is clicked on again, the check mark is cleared and the Use Assistance circle mode is cancelled. | 7.7.2.2 Creating a route by using the assistant circle function |
| [WPT Reverse Order] | When this item is selected by clicking on the item, the order of the WPT that is currently selected can be reversed. | - |

[6] Display area switching button

Chart display can be changed to the display area/scale suitable for the editing.

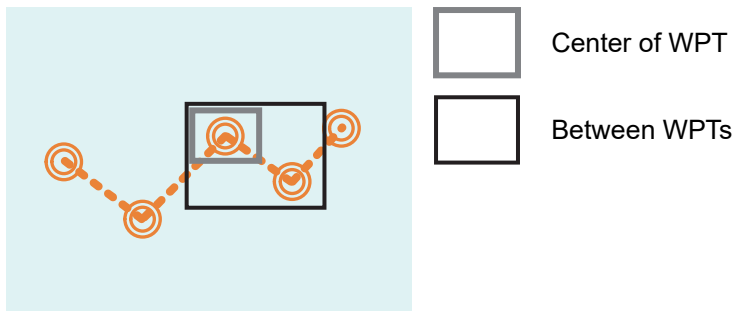
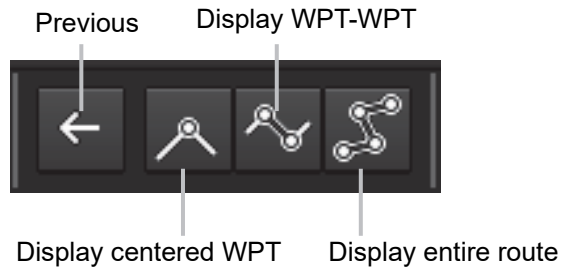

| Button name | Function |
|------------------------|---|
| [Previous] | Switches the chart display to the display area/scale before the chart display was switched. |
| [Display centered WPT] | Displays the WPT that is currently being edited at the center of the chart. |
| [Display WPT-WPT] | Displays on the chart the WPT that is currently being edited and the previous WPT. |
| [Display entire route] | Displays the entire route that is being edited on the chart. |

[7] Multi view switching button

A method of splitting a chart can be selected.

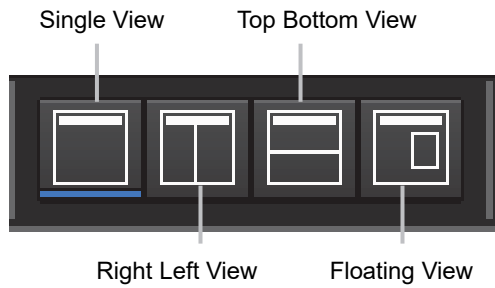

| Button name | Function | Display image |
|---------------------------------------|--|---------------|
| [Single View] | Displays a chart on a single screen. | |
| [Right Left View] | Displays a chart by splitting it into 2 screens of left and right. | |
| [Top Bottom View] | Displays a chart by splitting it into top and bottom. | |
| [Picture in Picture] (Dialog view) | Displays a dialog box of another chart inside of the chart screen. | |

[8] [Display full] (Full screen display) button

A chart can be displayed in full screen mode by clicking on this button that clears the operation section and display section other than the [Route Planning] dialog box. When this button is clicked on again, the operation section and the display section are re-displayed.

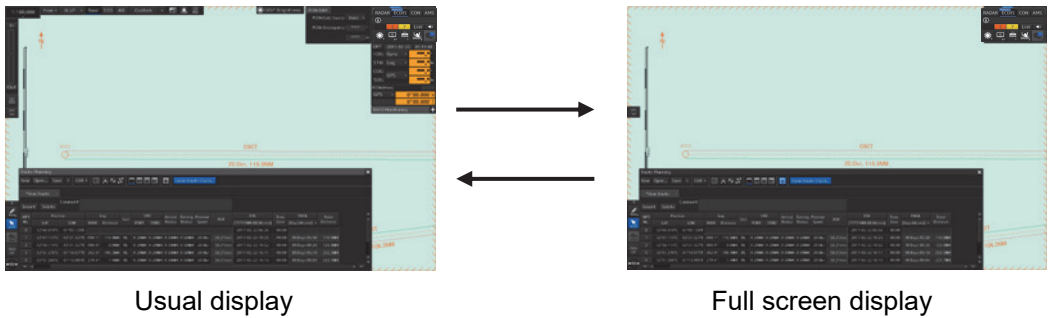

Usual display

Full screen display

[9] [Show Route Check...] (Route check screen display) button

When this button is clicked on, the [Check Route] dialog appears. When an error is detected, the error count is displayed with a badge.

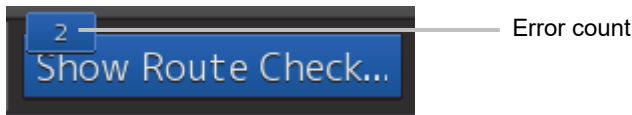

For the details of the [Check Route] dialog, refer to "7.9 Checking Route Data".

7.4.2 Route planning tab

When a route file is opened, a route plan tab comprising a file name display section and route data is displayed. Up to four route planning tabs can be displayed concurrently.

File name display section

The file names that are currently opened are displayed in the tabs. When the display of the file name is clicked on, the route file can be switched.

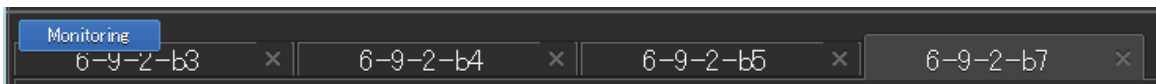

"*" is attached to the top of the name of the file you are editing.

A badge is displayed on the name of the file that is being monitored or under automatic sailing.

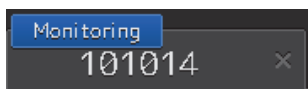

Monitoring badge

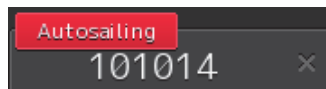

Automatic sailing badge

When the [X] button on the file name display section is clicked on, the tab is closed. If an attempt is made to close the tab that has not been saved, a save confirmation message dialog box appears.

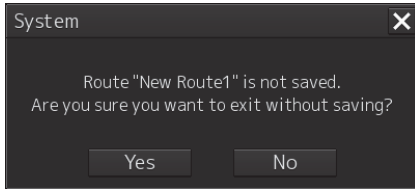

To close the tab by saving the route file by overwriting, click on the [Yes] button. When not saving the route file by overwriting, click on the [No] button. When the [X] button is clicked on, the file returns to the state prior to the clicking on the [X] button on the file name display section.

Route data

WPTs that form the route and the WPT data are displayed in a list.

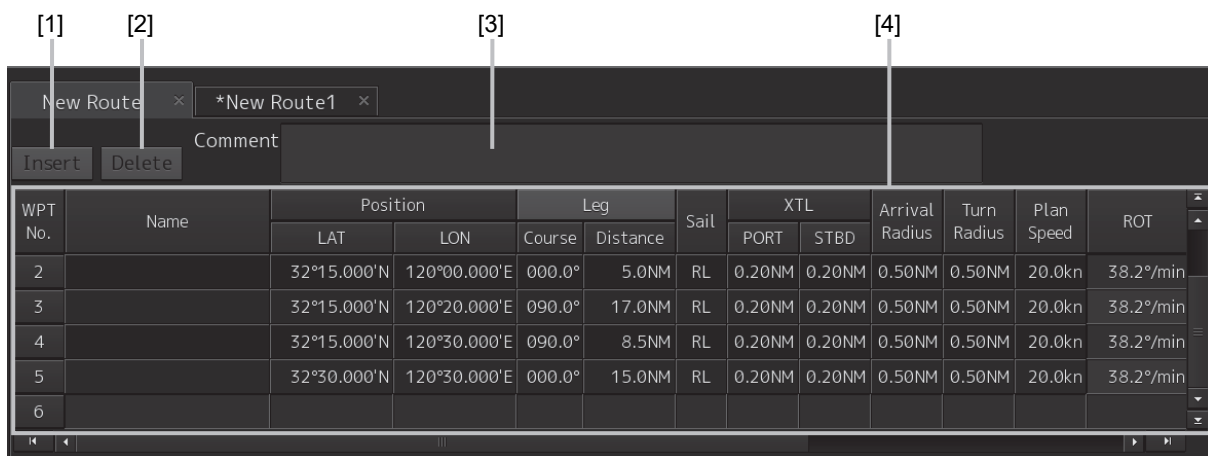

Route Data

[1] [Insert] button

A new WPT is inserted in the selected WPT.

[2] [Delete] button

The selected WPT is deleted.

[3] [Comment] field

The comment of the route file is displayed.

[4] WPT list

Data of each WPT is displayed.

7.5 Saving a Route

- 1 Click on the [Save] button on the Route Planning bar.



Or select the [Save] button that is displayed by clicking on the Route Planning menu button

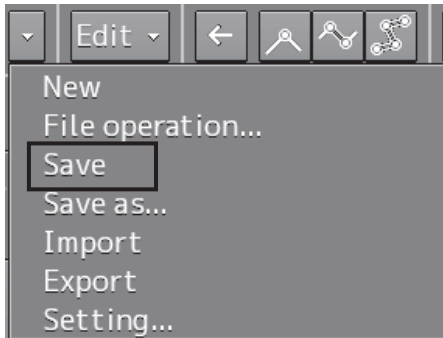

At creation of a new route, a [Save as Route File] dialog box appears.

Perform Steps 2 to 4 in the [Save as Route File] dialog.

When the existing route file is saved, the [Save as Route File] dialog box does not appear since the file is overwritten.

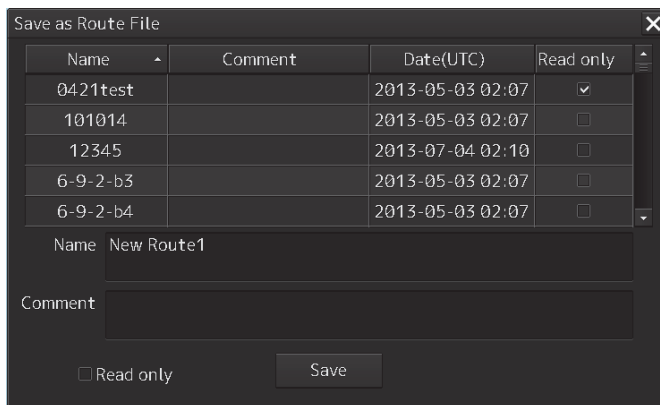

- 2 Enter [Name] and a comment in [Comment] as required.

Note

Although up to 64 characters are allowed for a route name, only 8 characters are output when the information is transmitted to another equipment as the route information (RTE sentence).

Memo

When all the files that have been saved are opened, all the file names may not necessarily be displayed. Files can be distinguished easily by entering comments.

3 Click on the [Save] button.

The file is saved.

4 The file name that is displayed on the Route Planning tab changes to the name that is specified in the [Name] box.

For the details of the Route Planning tab, refer to "7.4.2 Route planning tab".

When a route of the same file name already exists

1 When file saving operation is performed, a dialog box message appears confirming whether the file is to be overwritten.

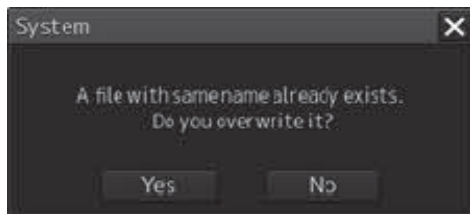

2 When overwriting the file, save the file by clicking on the [Yes] button. When not overwriting the file, close the dialog box by clicking on the [No] button and change the file name on the [Save as Route File] dialog box.

Memo

- The following message is displayed when an attempt is made to overwrite a protected file.

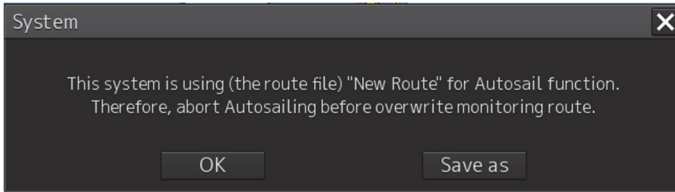

To cancel the save operation, close the dialog box by clicking on the [OK] button or the [X] button. When saving the file by changing the file name, click on the [Save as...] button. The dialog box is closed and the [Save as Route File] dialog box appears.

- The following message is displayed when an attempt is made to overwrite the route file that is currently being monitored.

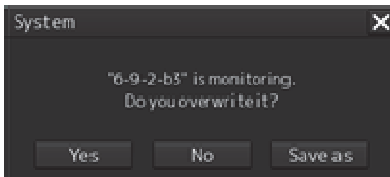

To cancel the save operation, click on the [No] button or [X] button. To continue the monitoring of the updated route by saving the route file by overwriting, click on the [Yes] button. When saving the file by changing the file name, click on the [Save as...] button. The dialog box is closed and the [Save as Route File] dialog box appears.

- The following message is displayed when an attempt is made to overwrite the file of the route under automatic sailing.

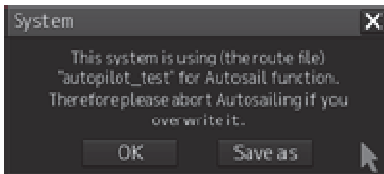

To cancel the save operation, close the dialog box by clicking on the [OK] button or the [X] button. When saving the file by changing the file name, click on the [Save as...] button. The dialog box is closed and the [Save as Route File] dialog box appears.

The monitored route does not change by the save operation.

Note

When editing the file of the route being monitored, if the limit check detects a turning radius error ("The straight route can not be created."), The following popup will be displayed when saving.

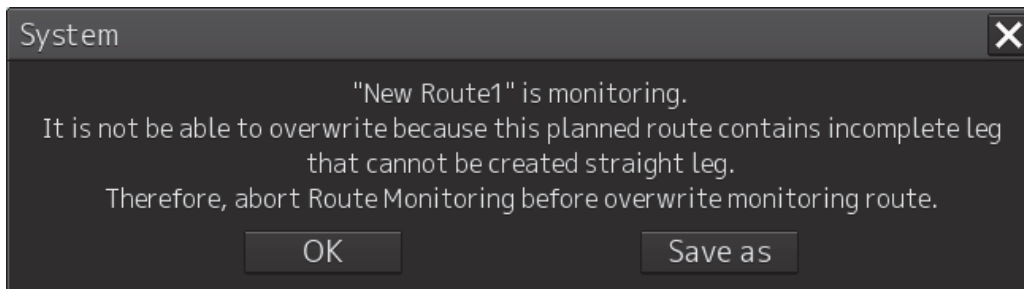

To cancel the save operation, close the dialog box by clicking on the [OK] button or the [X] button. When saving the file by changing the file name, click on the [Save as...] button. The dialog box is closed and the [Save as Route File] dialog box appears.

Saving a route file by naming the file

Click on [Save as...] of the route planning menu button on the Route Planning bar.

When the [Save as Route File] dialog box appears, save the file by entering a new file name.

Setting a route file to a Read Only mode (disabling editing)

Check Read only for the file that is to be set to [Read only] (disabling editing) mode. To cancel Read Only (disabling editing) specification, clear the check.

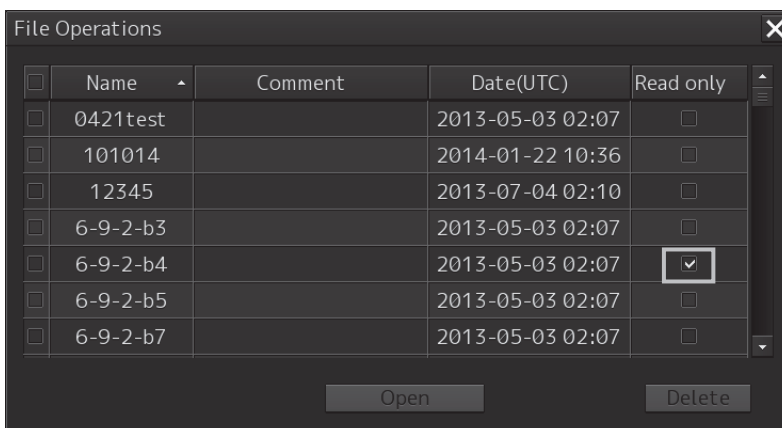

7.6 Planning a Route by Using Table Editing

CAUTION



Edit the navigation route according to the world geodetic system (WGS-84).
If you use the navigation route edited by a geodetic system other than the world geodetic system, an accident may occur.

7

7.6.1 Table editing operation flow

7.6.1.1 Creating a new route file

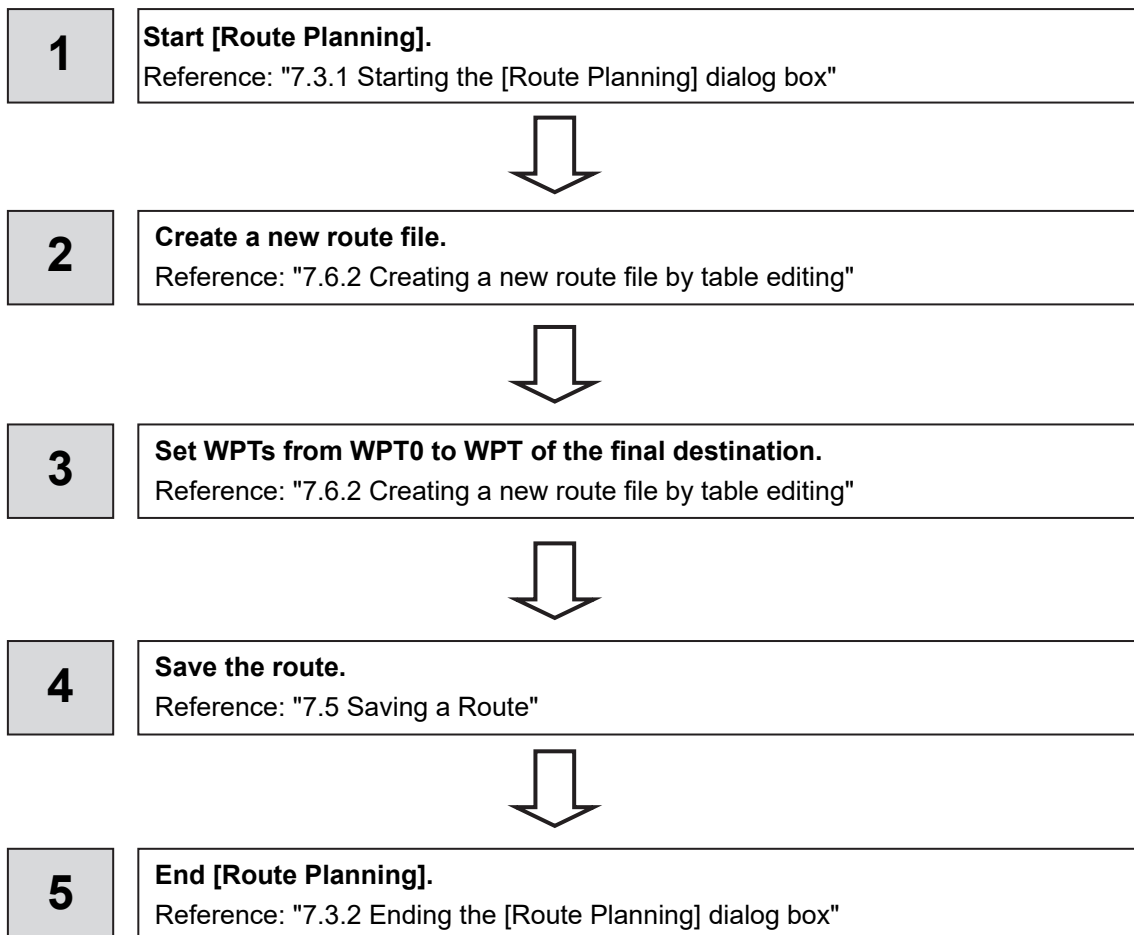

7.6.1.2 Editing a route

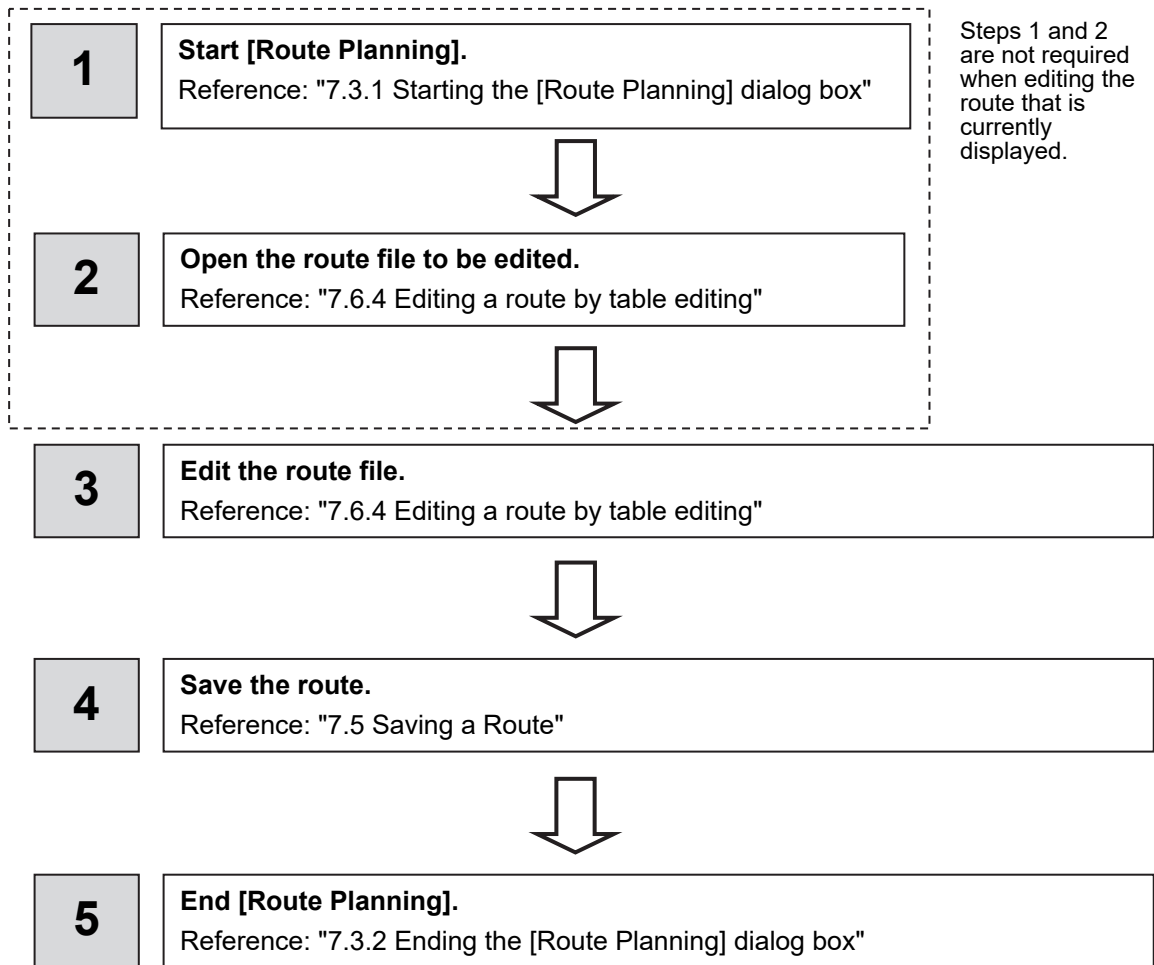

7.6.2 Creating a new route file by table editing

- 1 Click on the [New] button on the Route Planning bar



Or select the [New] button that is displayed by clicking on the Route Planning menu button.

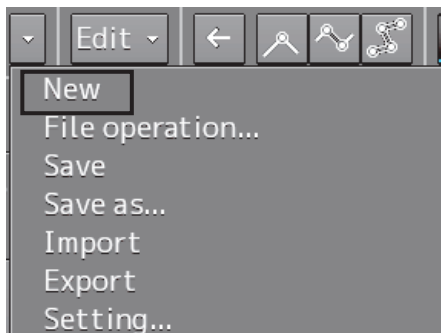

A new tab is added.

The screenshot shows the 'New Route' dialog box with a table for editing route waypoints. The table has columns for WPT No., Name, Position (LAT, LON), Leg (BWW, Distance), Sail, XTD (PORT, STBD), Arrival Radius, and Turning Radius. The Position columns contain asterisks indicating input fields.

| WPT No. | Name | Position | | Leg | | Sail | XTD | | Arrival Radius | Turning Radius |
|---------|------|----------|-------|-----|----------|------|------|------|----------------|----------------|
| | | LAT | LON | BWW | Distance | | PORT | STBD | | |
| | | ***** | ***** | | | | | | | |

- 2 Enter the latitude and the longitude of WPT0 (waypoint 0)

Enter the latitude by clicking on [LAT] of [Position].

Enter the longitude by clicking on [LON] of [Position].

Use the software keyboard for entering the latitude and longitude.

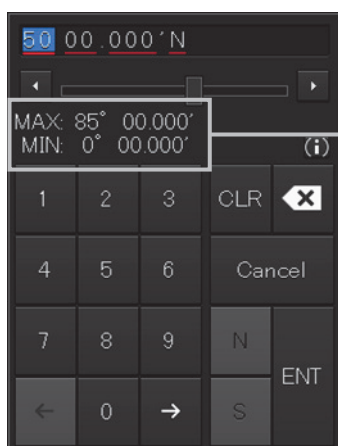

Latitude software keyboard

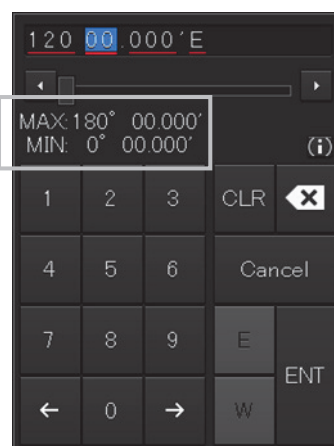

Longitude software keyboard

Range of the values that can be entered

Memo

The maximum latitude input range of Position is 85 ° 00.000 (polar range restriction).

3 Set the following items as required.

*Some items are for display only and cannot be set.

| Item | Description |
|---|---|
| [Name] | Set a name of WPT. |
| [Leg Course] | This is the bearing from the previous WPT and is not set in WPT0. The specifiable range is from 0.0° to 359.9°. Editing is disabled when [GC] is selected in [Sail]. |
| [Leg Distance] | This is the distance from the previous WPT and is not set in WPT0. The specifiable range is from 0.0 to 9999.9 NM. Editing is disabled when [GC] is selected in [Sail]. |
| [Sail] | [RL] or [GC] can be selected from the list. |
| [XTD PORT] (Port side cross track limit) | Set a port side cross track limit. The specifiable range is from 0.01 to 5.00 NM. |
| [XTD STBD] (Starboard side cross track limit) | Set a starboard side cross track limit. The specifiable range is from 0.01 to 5.00 NM. |
| [Arrival Radius] | Sets the arrival radius. (0.01 to 9.99 NM) |
| [Turn Radius] (Turning radius) | Sets the turning radius. (0.00 to 9.99 NM) |
| [Plan Speed] (Planned speed) | Sets the planned ship's speed. (1.0 to 99.9kn) |
| [ROT] | ROT is automatically calculated from the planned speed and turning radius. |
| [ETA] | ETA is automatically calculated from the position of WPT, planned speed, and time zone. |
| [Time Zone] | The time difference of the time of arrival can be input within the range from -13.30 to +13.30. |
| [TWOL] | TTG can be automatically calculated from the position of WPT and planned speed. ※[Setting]-[Route]-[Monitoring]-[Arrivalcircle] selected:[TTG] |
| [Total Distance] | This is the total distance between WPT0 and the final WPT. |

Memo

The values that are set by selecting [Settings] – [Route] on the menu is reflected in [Sail], [XTD PORT], [XTD STBD], [Arrival radius], [Turn Radius], [Plan Speed], and [Time Zone]. For the details, refer to "16.8 Setting up Parameter Values at Route Planning Creation".

4 Add the next WPT by clicking on the next WPT No. or the [Insert] button after entering the latitude and longitude.

| 6-9-2-b4 | | *New Route | | Comment | |
|----------|------|-------------|--------------|---------|----------|
| WPT No. | Name | Position | | Leg | |
| | | LAT | LON | Course | Distance |
| 0 | | 32°00.000'N | 120°00.000'E | | |
| 1 | | | | | |

WPT1 is added.

- 5 Set the item as indicated in Step 3.
- 6 Enter data up to the last WPT with the same procedure.
The route based on the input data is displayed each time.

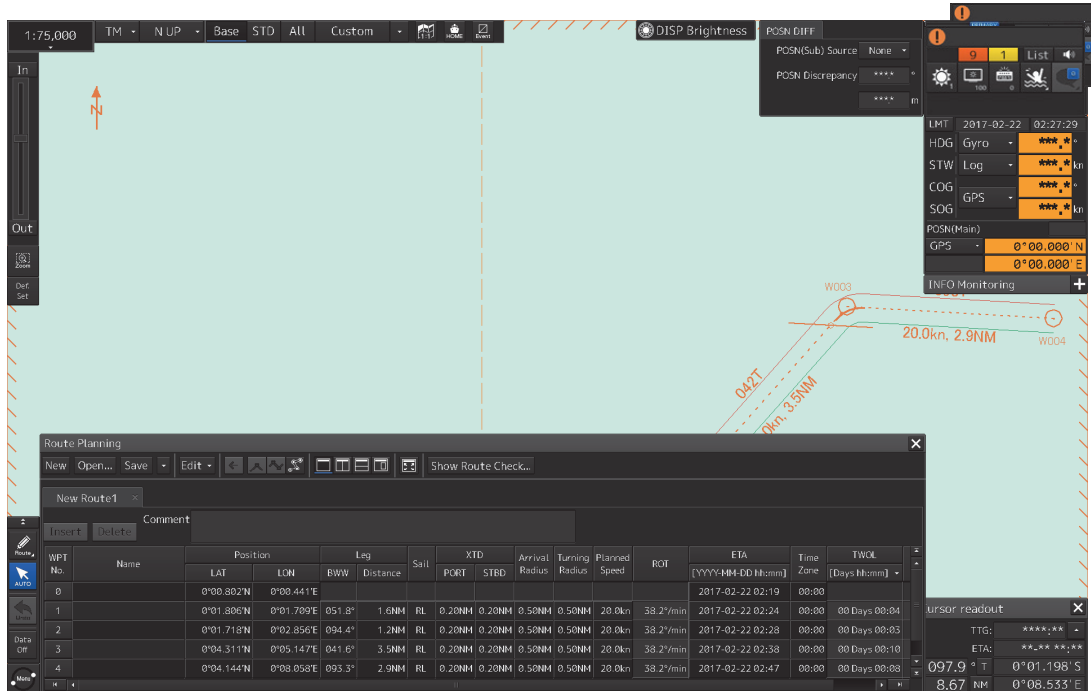

- 7 After completing the creation, save the route file.
For the saving procedure, refer to "7.5 Saving a Route".

7.6.3 Deleting WPT data

- 1 Select WPT data to be deleted and click on the [Delete] button.

7.6.4 Editing a route by table editing

Memo

Steps 1 and 2 are not required when editing the route that is currently displayed.

- 1 Click on the [Open] button on the Route Planning bar

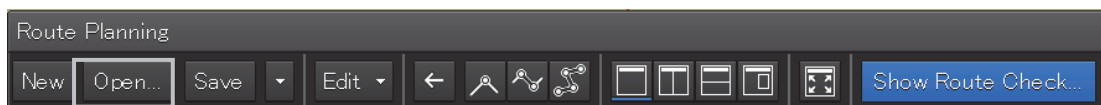

Or select the [File operation...] button that is displayed by clicking on the Route Planning menu button.

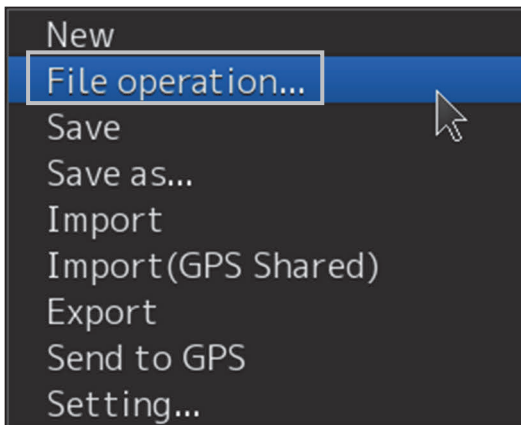

The [File operation] dialog box appears.

2 Select the route file to be edited and click on the [Open] button.

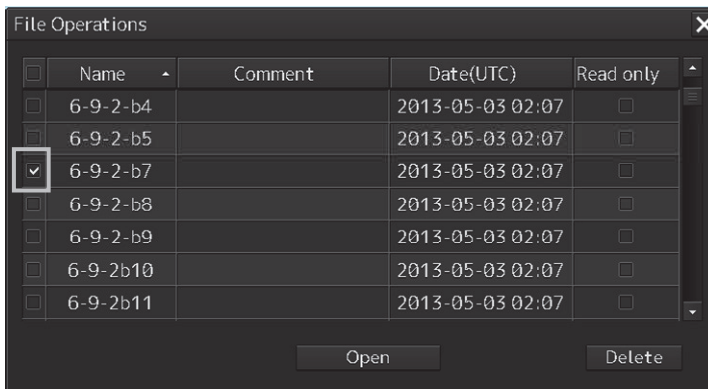

Memo
 If [Read only] is selected, the file overwrite function is disabled. To overwrite the existing file, clear the item before opening the file.

The route file is displayed on the [Route Planning] dialog box.

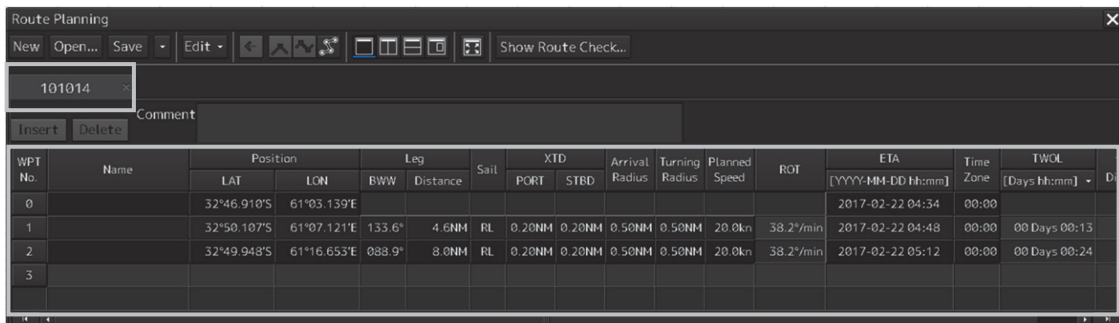

For the details of the Route Planning tab, refer to "7.4.2 Route planning tab".

3 Select WPT No. of WPT to be changed and click the right mouse button.

The context menu is displayed.

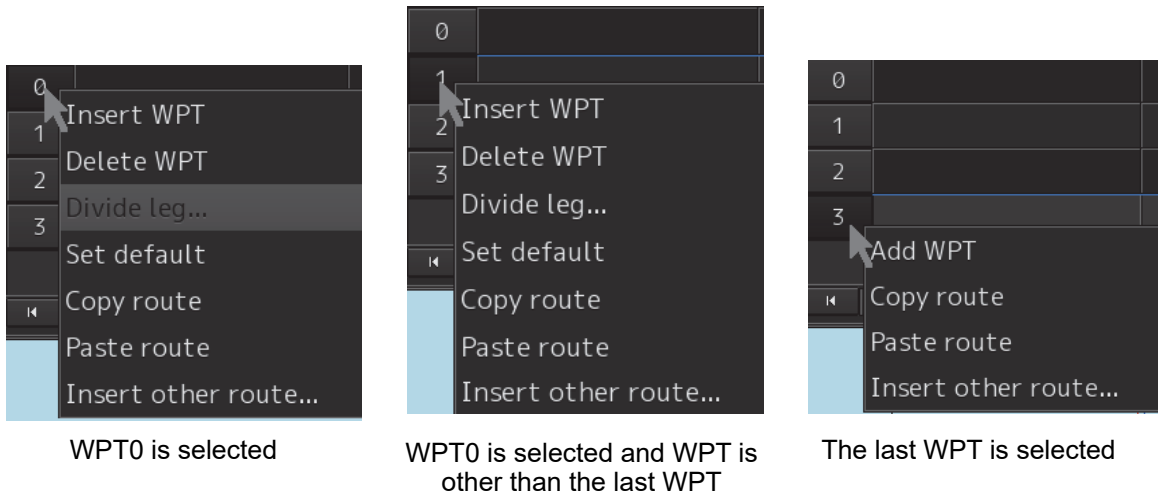

A route can be edited by selecting the "Edit" mode from the context menu.

The procedures for editing are as follows.

| Menu button name | Function | Related section |
|--------------------|--|---|
| Insert WPT | Adds WPT. | 7.6.4.1 Route Planning bar |
| Delete WPT | Deletes WPT. | 7.6.4.2 Deleting WPT |
| Divide leg... | Displays a leg division dialog box. Divides the leg in the dialog box. | 7.6.4.3 Dividing a leg |
| Set default | Reflects the initial value of the route plan setting in the specified WPT. | — |
| Copy route | Copies the entire route. | 7.6.4.4 Copying the entire route |
| Paste route | Pastes the copied course to the last WPT of the course. | 7.6.4.5 Pasting the copied route |
| Insert other route | Displays the insertion dialog of some other route. Inserts some other dialog in the route that is being edited on the dialog. | 7.6.4.6 Inserting the other route |
| Add WPT | Inserts the WPT of the same value as the last WPT. | 7.6.4.7 Insert the same WPT as the last WPT |

-
-
- 4** After completing the editing, click on the [Save] button on the Route Planning bar.

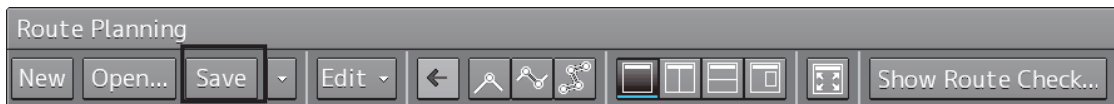

Or select the [Save] button that is displayed by clicking on the Route Planning menu button

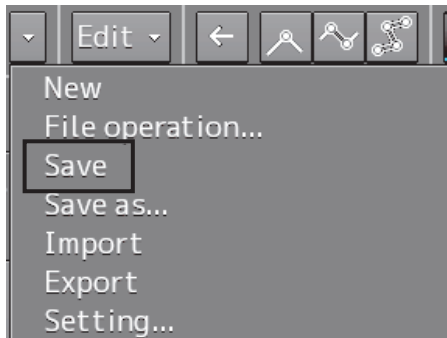

For the details of save operation, refer to "7.5 Saving a Route ".

7.6.4.1 Inserting WPT

Insert the WPT of the same value as the selected WPT.

- 1** Click the right mouse button on the WPT No. of the WPT to be inserted.
The context menu is displayed.
- 2** Click on [Insert WPT] of the context menu.
WPT is inserted following the selected WPT.

7.6.4.2 Deleting WPT

Delete the selected WPT.

- 1** Click the right mouse button on the WPT No. of the WPT to be deleted.
The context menu is displayed.
- 2** Click on [Delete WPT] on the context menu.
The selected WPT is deleted.

7.6.4.3 Dividing a leg

A leg can be divided by setting a longitude or a nautical mile.

- 1 Click the right button on the WPT No. to be divided.**
The context menu is displayed.
- 2 Click on [Divide leg...] of the context menu.**
The [Divide Route] dialog box appears.

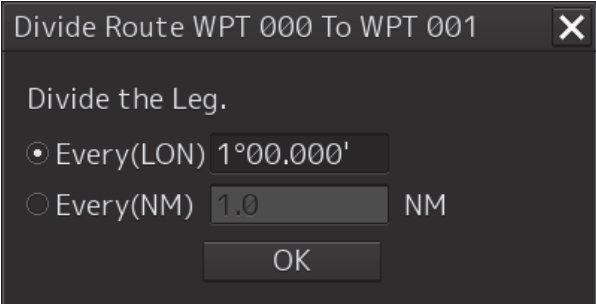

- 3 Enter a division interval.**
[Every (LON)] (Longitude division)
 - 1) Click on "Every(LON)".
 - 2) Enter a longitude interval for division.**[Every(NM)] (Nautical mile division)**
 - 1) Click on "Every(NM)".
 - 2) Enter a nautical mile interval for division.
- 4 Click on the [OK] button.**
The leg that is selected in Step 1 is divided in the unit that is specified in Step 3.

Note
When the total number of WPTs exceeds the maximum value of 511 as a result of leg division, leg division is executed within the range of 511 in the entire route.

7.6.4.4 Copying the entire route

Copy the entire route that is selected.

- 1 Click the right mouse button on the WPT No. other than the last WPT.**
The context menu is displayed.
- 2 Click on [Copy route] on the context menu.**
The entire route is copied.

7.6.4.5 Pasting the copied route

The route that was copied to the last WPT of the route is pasted.

- 1 Click the right mouse button on the WPT No. of the WPT on which the route is to be pasted.**

The context menu is displayed.

- 2 Click on [Paste route] in the context menu.**

The routes are pasted(inserted).

Note

After pasting the copied route, when a route planning error occurs as a result of recalculation of the Course, Distance, Total Distance, ROT, TTG, and ETA, an error message is displayed and the route will not be pasted.

Memo

The same operation is performed also when the next No. button of the last WPT is clicked.

7.6.4.6 Inserting the other route

Insert the route of some other file into the final WPT of the route.

- 1 Click the right button on WPT No.**

A context menu is displayed.

- 2 Click on [Insert other route] in the context menu.**

The [Insert other route] dialog is displayed.

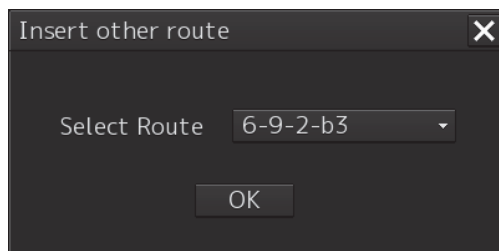

- 3 Select a route file to be inserted from the [Select Route] combo box.**

- 4 Click on the [OK] button.**

The route file is inserted.

Note

If the range can be inserted is exceeded, an error message is displayed and the route will not be inserted.

7.6.4.7 Insert the same WPT as the last WPT

Insert the same WPT as the last WPT following the last WPT.

- 1 Click the right mouse button on the WPT No. of the last WPT.**

The context menu is displayed.

- 2 Click on [Add WPT] on the context menu.**

WPT is added following the last WPT.

7.7 Planning a New Route by Graphic Editing

CAUTION



Edit the navigation route according to the world geodetic system (WGS-84).
If you use the navigation route edited by a geodetic system other than the world geodetic system, an accident may occur.

7

7.7.1 Graphic editing operation flow

7.7.1.1 Creating a new route file

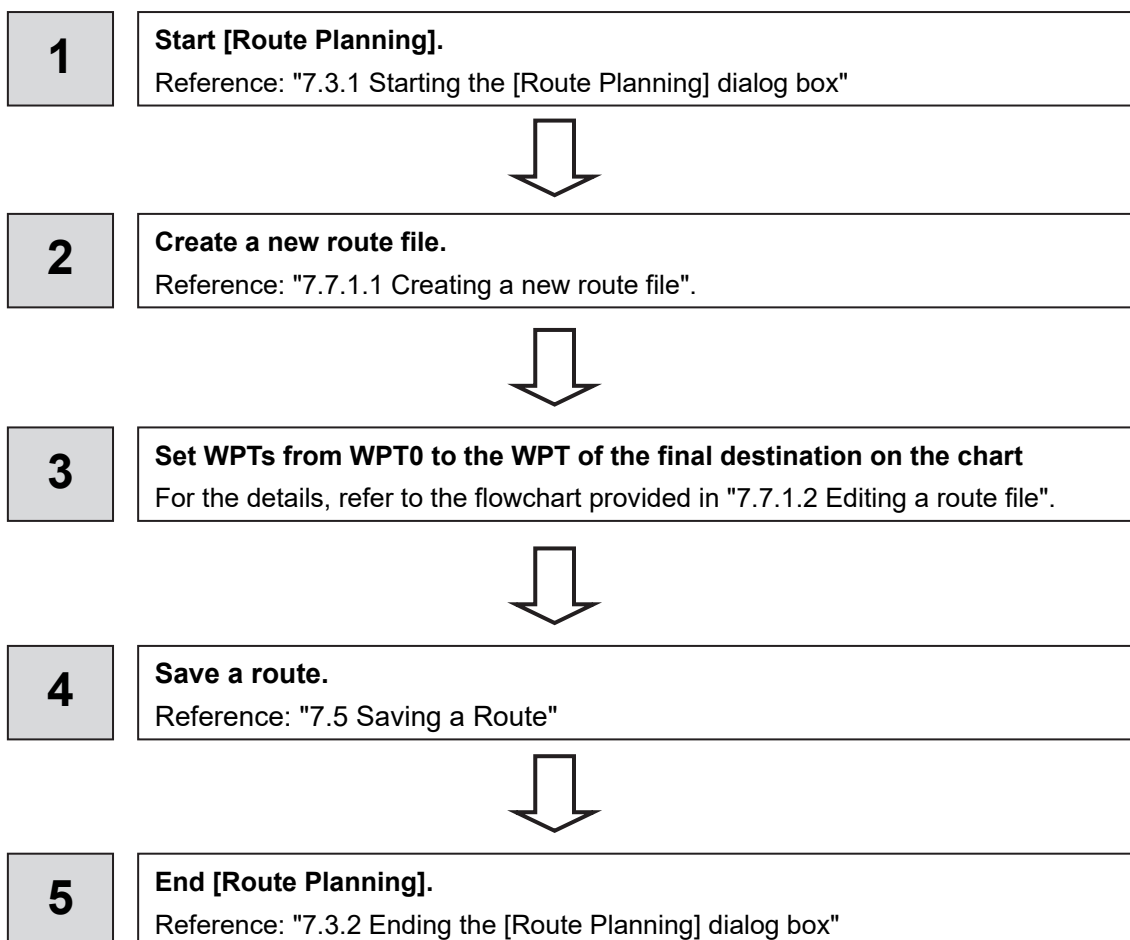

7.7.1.2 Editing a route file

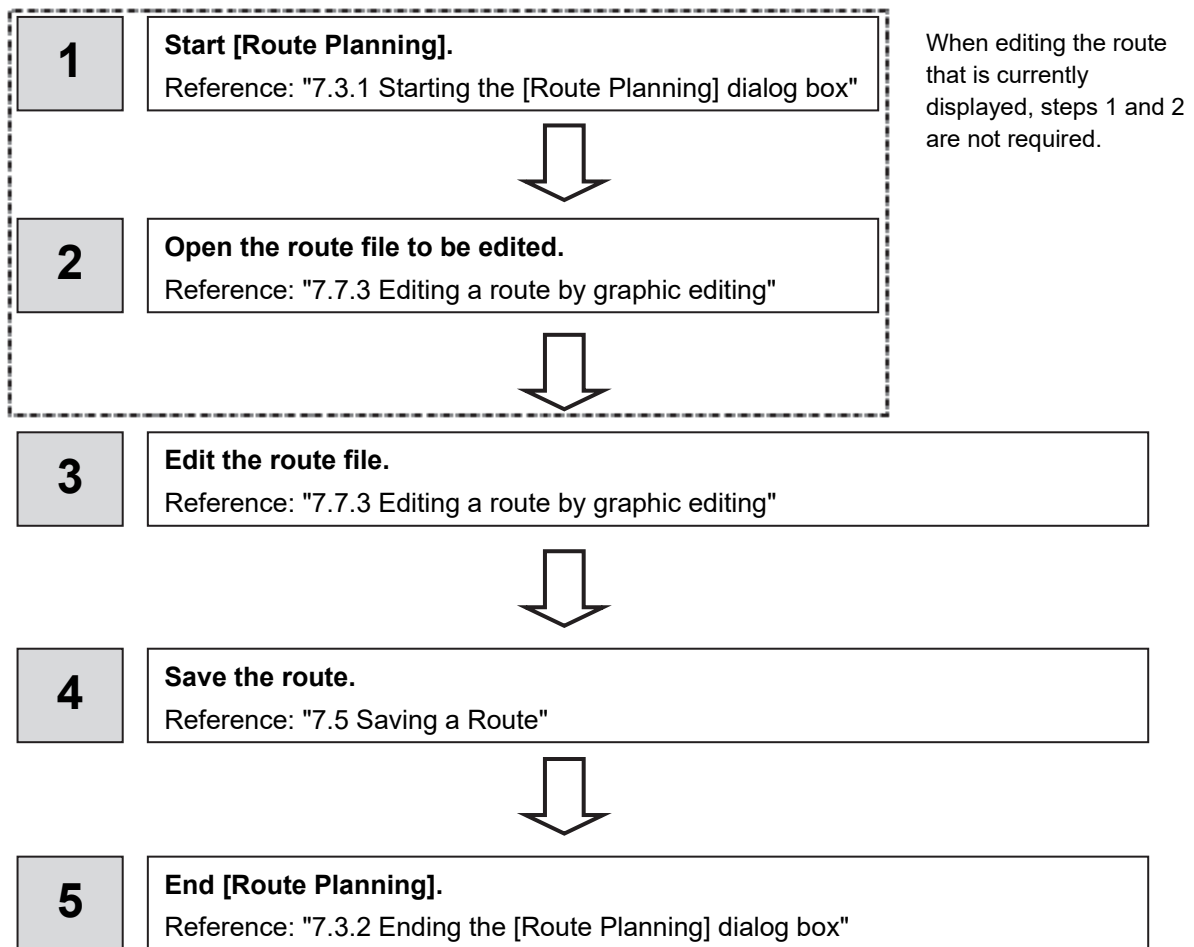

7.7.2 Creating a new route file by graphic editing

- 1 Click on the [New] button on the Route Planning bar.



Or select the [New] button on the menu that is displayed by clicking on the Route Planning menu button.

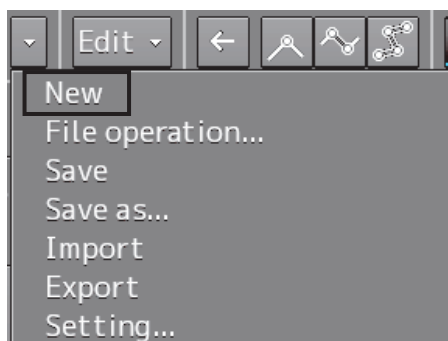

- 2 Placing the cursor on the WPT0 position.

The latitude and the longitude of the WPT are displayed near the cursor.

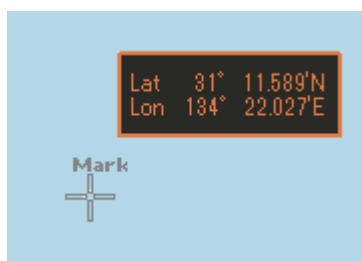

- 3 Click the mouse button.

WPT0 is added.



4 Move the cursor.

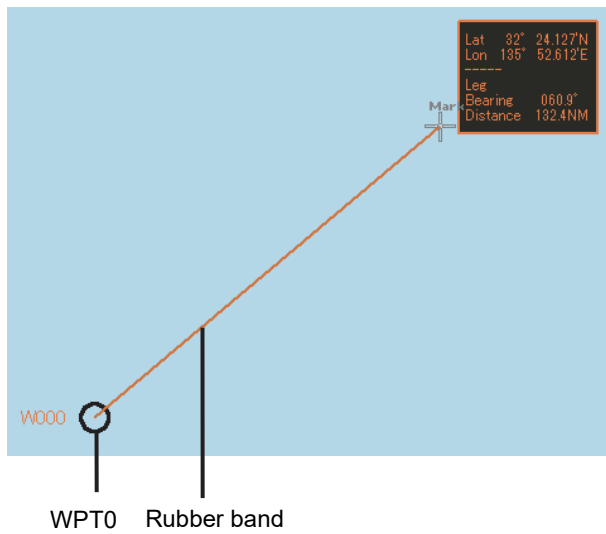

5 Click the mouse button.

WPT1 is added at the cursor position.

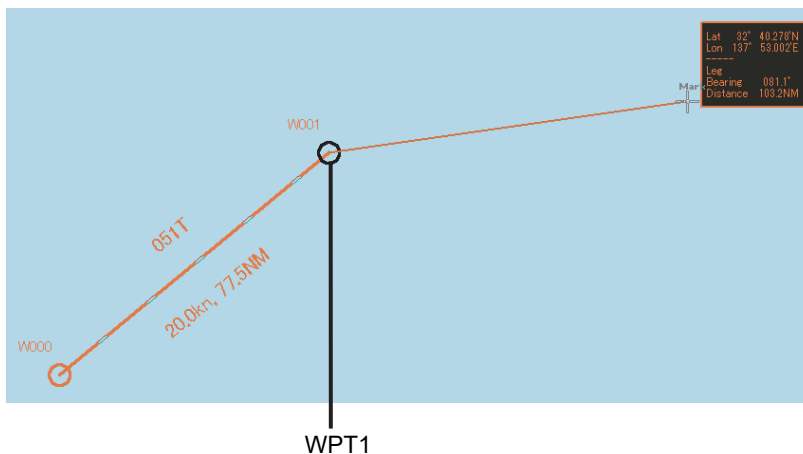

6 Add as many WPTs as required in the same way.

7 After creating the last WPT, double-click the left button or click the right button.

The Route planning is terminated.

Note

In the case of ARCS, when a WPT is specified at a position other than the active chart and another panel exists at the position, the panel display is switched automatically.

8 Save the route file that was created.

For the details of how to save the file, refer to "7.5 Saving a Route".

7.7.2.1 Creating a route by using EBL/VRM

- 1 Click on [Use EBL/VRM] on the [Edit] button to select it.

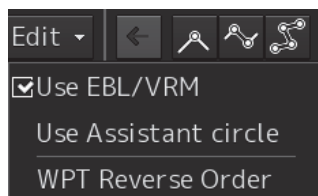

The cursor changes to EBL/VRM.

- 2 Move the cursor to the position used as the mark (example: headland) and click on the position.

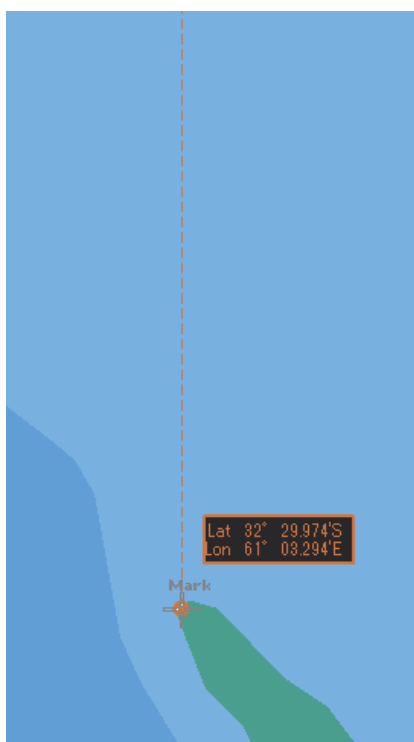

-
-
- 3** Move the cursor and determine the WPT position while checking the bearing from the position used as the mark.



The latitude/longitude is displayed next to the cursor.

- 4** Click the mouse button.

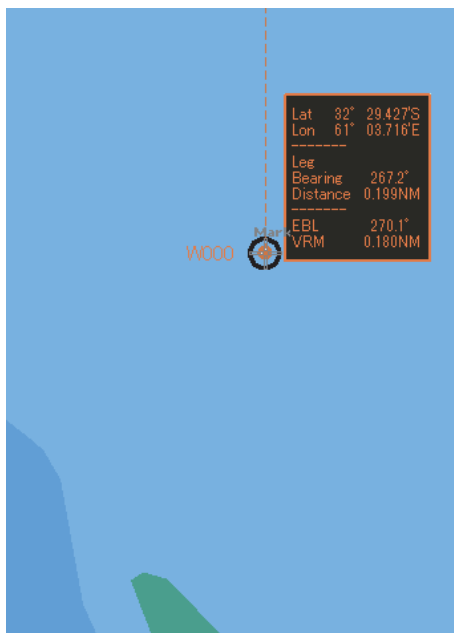

WPT0 is created.

- 5** Add as many WPTs as required in the same way.

Memo

When EBL/VRM is not used for creation of the next WPT, clear the item by clicking on [Use EBL/VRM].

- 6** After creating the last WPT, double click the left button or click the right button.
The Route planning is terminated.

7.7.2.2 Creating a route by using the assistant circle function

A route can be created by using an assistant circle (supplementary line).

The assistant circle function adds WPT at the position where the mark such as headland and the leg intersects at right angles.

When the position that is used as the mark is determined and the cursor is moved to the position, WPT is added at the position where the leg and the position intersect at right angles.

- 1** Select the [Use Assistant circle] check box of the [Edit] button.

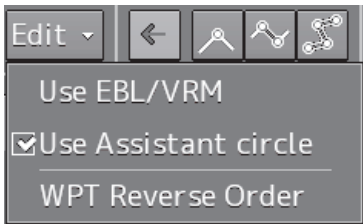

- 2** Move the cursor to any position and click the left button.

WPT0 is created.

- 3** Move the cursor to the position as the mark (example, headland) and click the button.

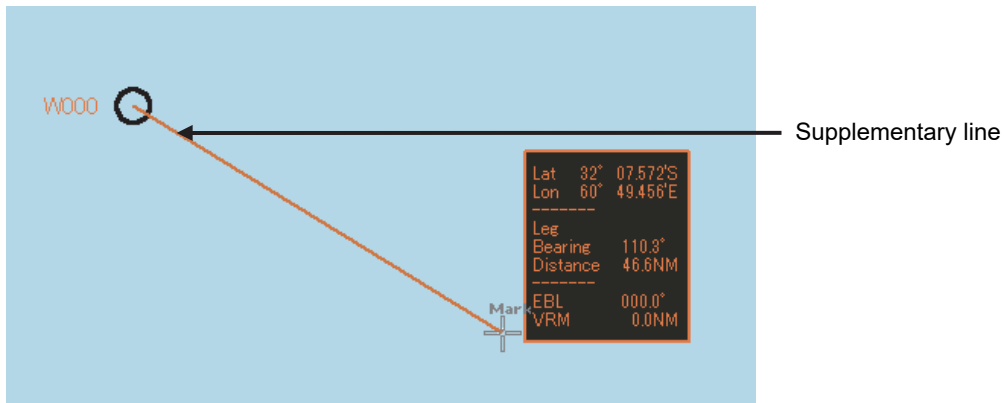

4 Move the cursor and click the button while checking the leg bearing.

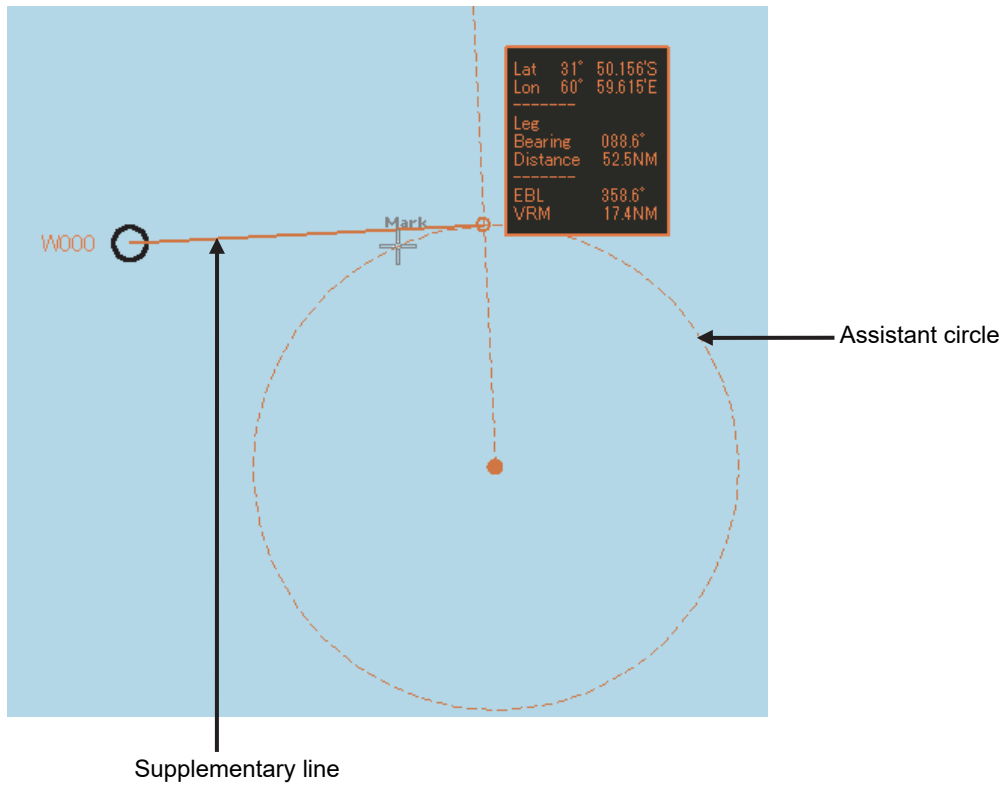

WPT1 is created at the intersecting point of the assistant circle and the supplementary line.

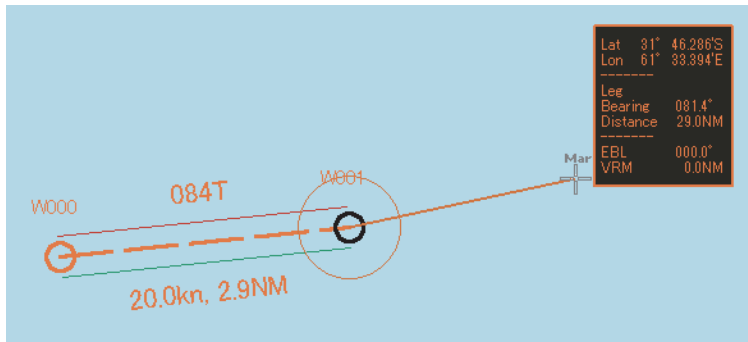

Memo

The direction of the leg varies according to the positional relationship of the cursor.

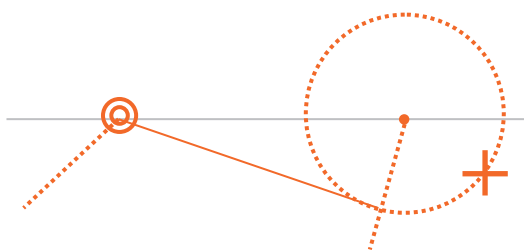

When the cursor is on the right side of the position of WPT and the position used as the mark, the leg will be on the lower side.

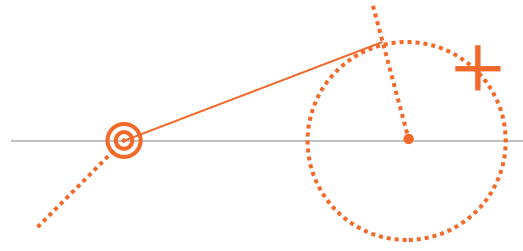

When the cursor is on the left side of the position of WPT and the position used as the mark, the leg will be on the upper side.

5 Add as many WPTs as required in the same way.

Memo
When Use Assistant circle is not used for creation of the next WPT, clear the item by clicking on [Use Assistant circle].

6 After creating the last WPT, double click the left button or click the right button.
The Route planning is terminated.

7.7.3 Editing a route by graphic editing

1 Click on the [Open] button on the Route Planning bar.



Or select the [File operation...] button that is displayed by clicking on the Route Planning menu button.

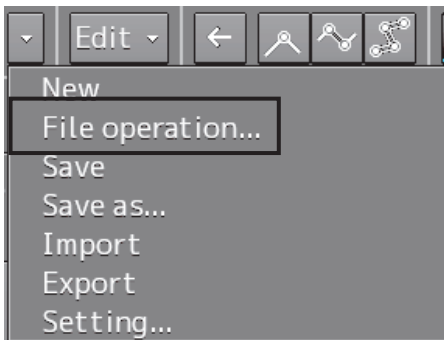

The [File operation] dialog box appears.

2 Select the route file to be edited and click on the [Open] button.

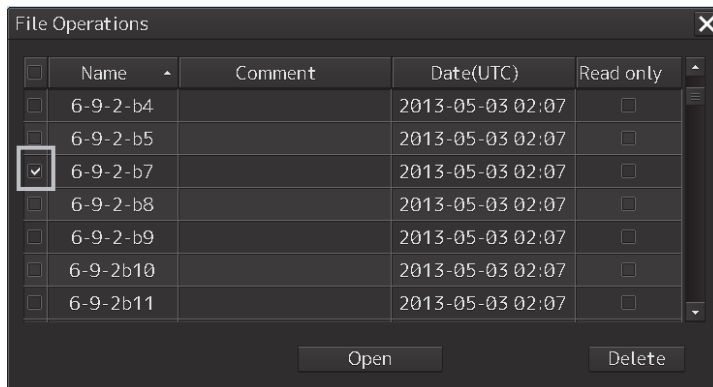

Memo
If [Read only] is selected, the file overwrite function is disabled. To overwrite the existing file, clear the item before opening the file.

3 Edit the route with graphic editing.

Refer to the following for the editing methods.

Editing operations that are allowed by clicking on WPT or a leg of the route

| Editing function | Related section |
|----------------------------------|--|
| Inserting WPT between WPTs | 7.7.3.1 Inserting a WPT between WPTs |
| Moving WPT | 7.7.3.2 Moving a WPT |
| Changing XTD (cross track limit) | 7.7.3.3 Changing XTD (cross track limit) |

Operations that are allowed on the context menu that is displayed by clicking the right mouse button on WPT or a leg of the route

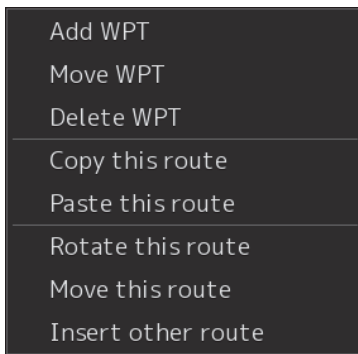

WPT0 or the last WPT is selected

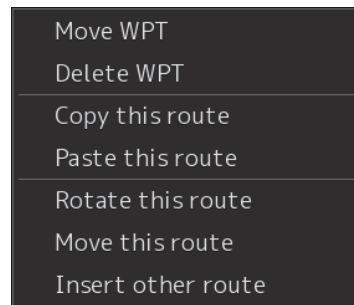

WPT other than WPT0 and the last WPT is selected

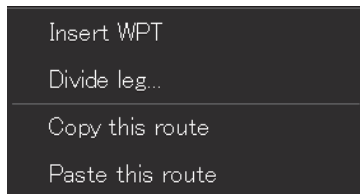

A leg is selected



XTD is selected

| Menu | Function | Related section |
|--------------------|--|---|
| Add WPT | Adds WPT. | 7.7.3.4 Adding WPT on the context menu |
| Move WPT | Moves WPT. | 7.7.3.5 Moving WPT on the context menu |
| Delete WPT | Deletes WPT. | 7.7.3.6 Deleting WPT on the context menu |
| Copy this route | Copies the entire route. | 7.7.3.7 Copying and pasting a route on the context menu |
| Paste this route | Pastes the copied route on to another route file. | |
| Rotate this route | Rotates the route. | 7.7.3.8 Rotating a route on the context menu |
| Move this route | Moves the route. | 7.7.3.9 Moving a route on the context menu |
| Insert other route | Inserts another dialog into the route that is being edited. | 7.7.3.10 Inserting other route on the context menu |
| Insert WPT | Inserts WPT between WPTs. | 7.7.3.11 Inserting WPT between WPTs on the context menu |
| Divide leg... | Displays a leg division dialog. Divides the leg in the dialog. | 7.7.3.12 Dividing a leg on the context menu |
| Change XTD | Changes the XTD (cross track limit). | 7.7.3.13 Changing XTD (cross track limit) on the context menu |

4 After completing editing, save the route file.

For the details of how to save the file, refer to "7.5 Saving a Route".

7.7.3.1 Inserting a WPT between WPTs

1 Click the left button on the leg between the WPTs in which a WPT is to be inserted.

The leg is set to a selected state.

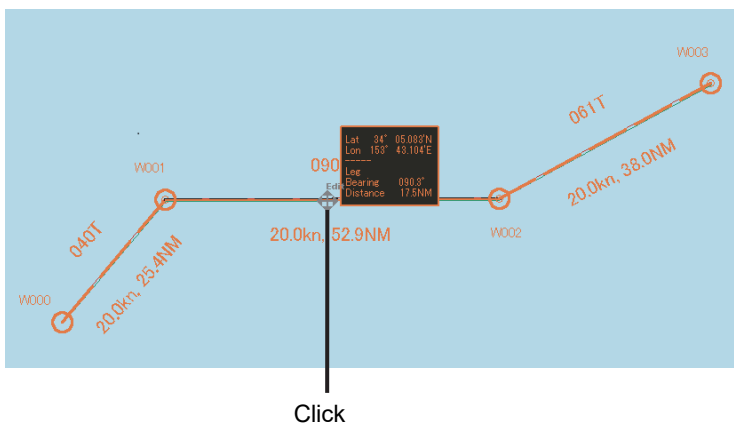

2 Determine the WPT insertion position by moving the cursor.

A rubber band is displayed.

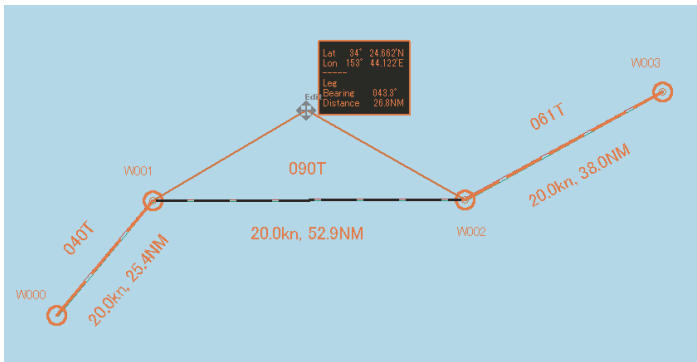

3 Click the mouse button.

A WPT is added.

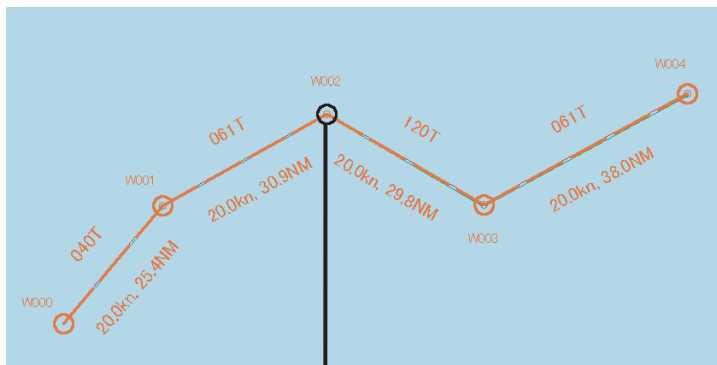

WPT that was added

Cancelling the operation

The addition operation can be cancelled by clicking the right button instead of clicking at Step 3.

7.7.3.2 Moving a WPT

1 Click on the WPT to be moved.

The WPT is set to a selected state.

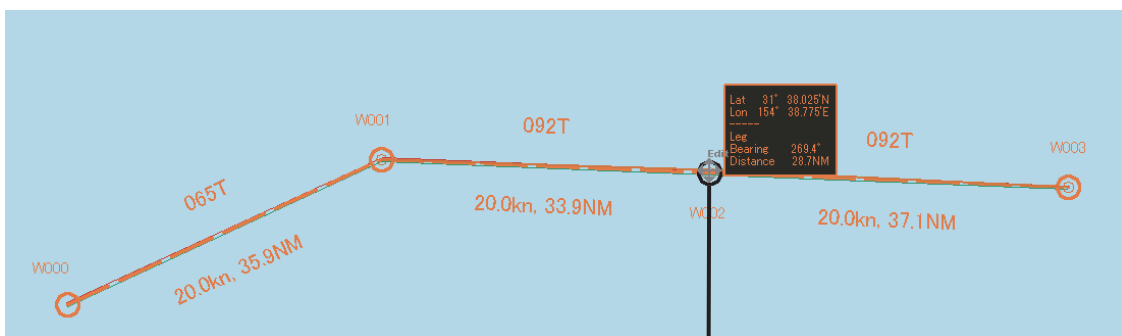

Click.

2 Move the WPT to any position.

A rubber band covering from the WPTs at the front and back to the cursor is displayed.

*In the case of WPT0 or the last WPT, a rubber band is displayed from one side.

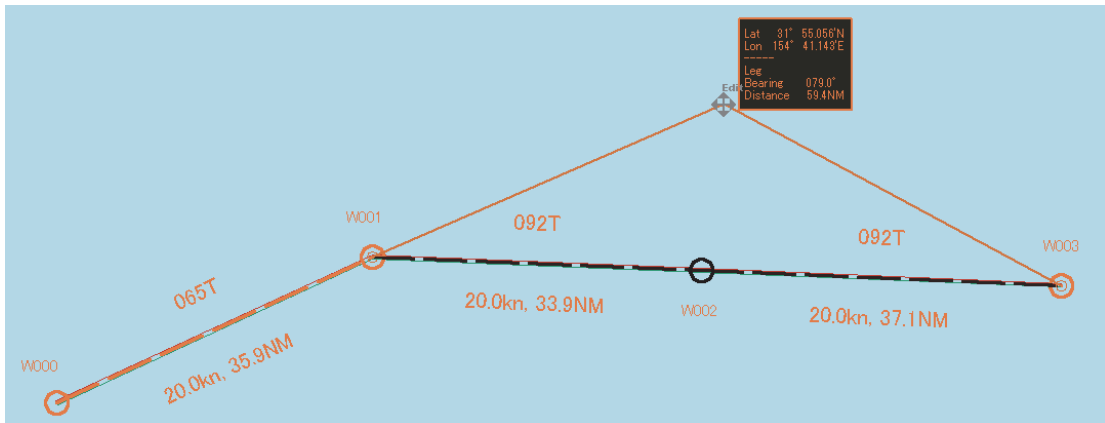

7

3 Click the mouse button.

The move is determined.



Cancelling the operation

The move operation can be cancelled by clicking the right button instead of clicking at Step 3.

7.7.3.3 Changing XTD (cross track limit)

1 Click on the XTD.

The cursor is changed to the XTD change mode.

2 Move the cursor and change the XTD.

Use the information (XTD distance) that is displayed near the cursor and the line that is linked to the cursor as the guideline.

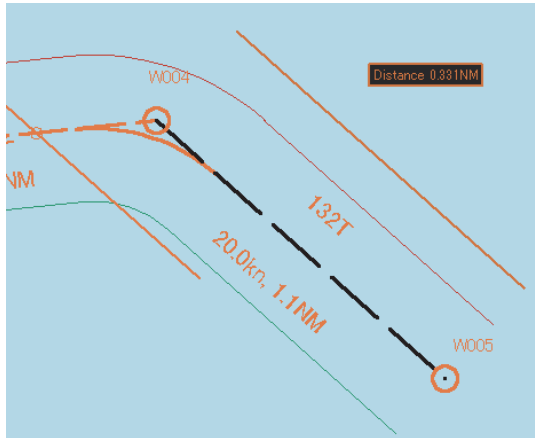

Note

The line cannot be moved exceeding the limit of XTD (5.00 NM).

3 Click the mouse button.

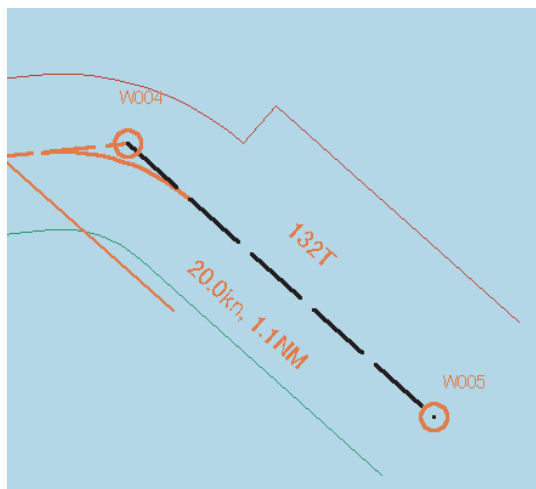

The width of the XTD is changed.

Cancelling the operation

The change operation can be cancelled by clicking the right button instead of clicking at Step 3.

7.7.3.4 Adding WPT on the context menu

Add a WPT to WPT0 or the last WPT.

- 1 Click the right mouse button on WPT0 or the last WPT.

The context menu is displayed.

- 2 Click [Add WPT] on the context menu.

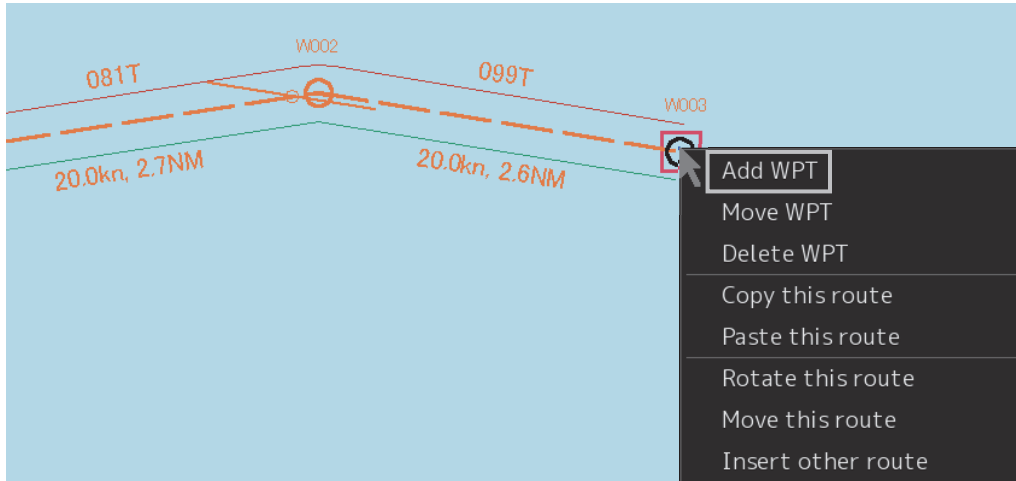

The cursor changes to the WPT addition mode.

- 3 Move the cursor on the position of the WPT to be added.

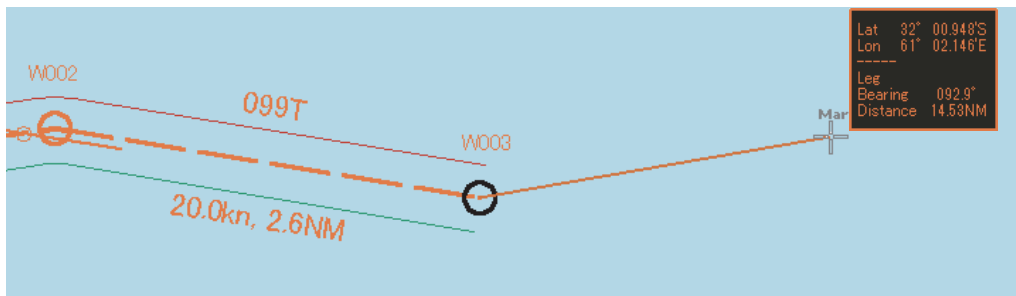

- 4 Click the mouse button.

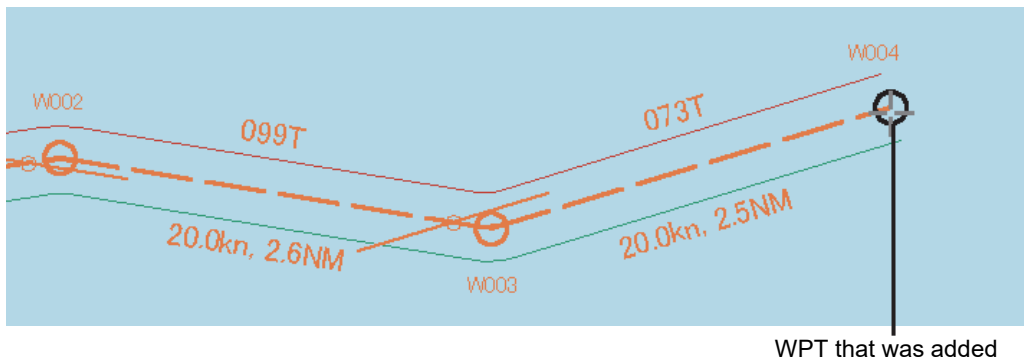

WPT is added.

Note
In the case of ARCS, when WPT is specified at a position other than the active chart and another panel exists at the position, the panel display changes automatically.

Cancelling the operation

The addition operation can be cancelled by clicking the right button instead of clicking at Step 4.

7.7.3.5 Moving WPT on the context menu

- 1 Click the right button on the WPT to be moved.

The context menu is displayed.

- 2 Click [Move WPT] on the context menu.

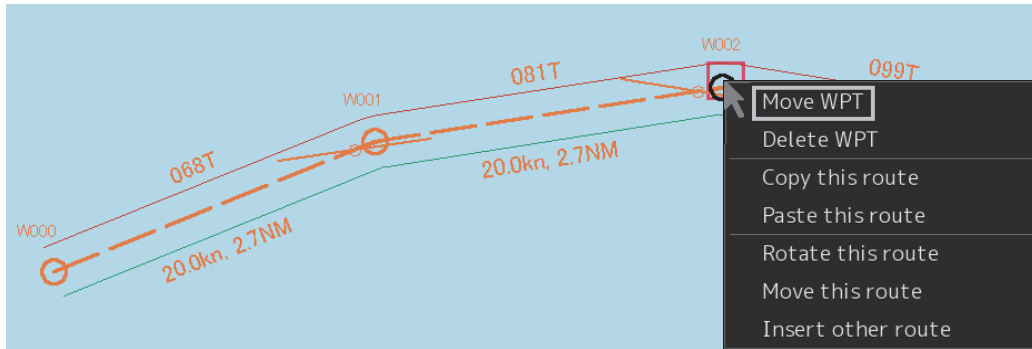

The cursor mode changes to the WPT move mode.

- 3 Move the cursor to the required position.

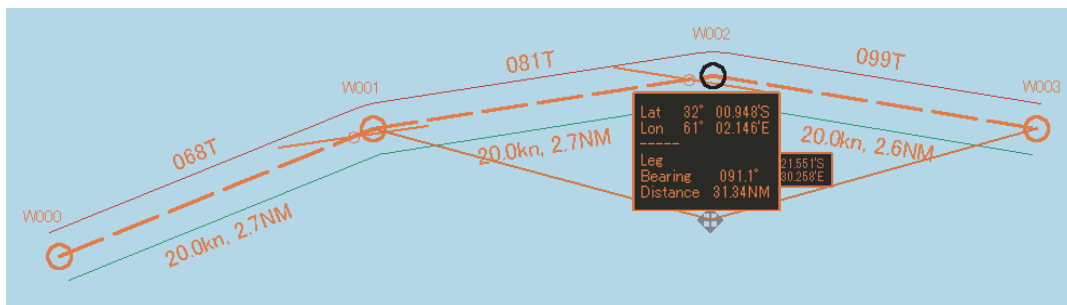

- 4 Click the mouse button.

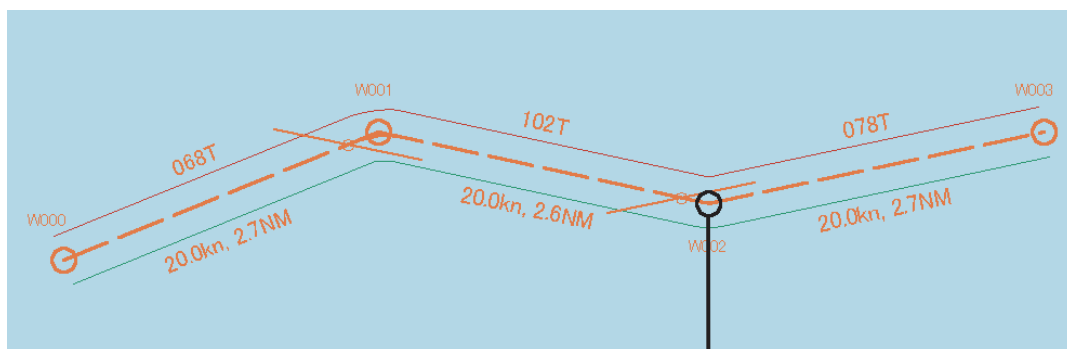

WPT that was moved.

Cancelling the operation

The addition operation can be cancelled by clicking the right button instead of clicking at Step 4.

7.7.3.6 Deleting WPT on the context menu

- 1 Click the right button on the WPT to be deleted.
The context menu is displayed.
- 2 Click [Delete WPT] on the context menu.

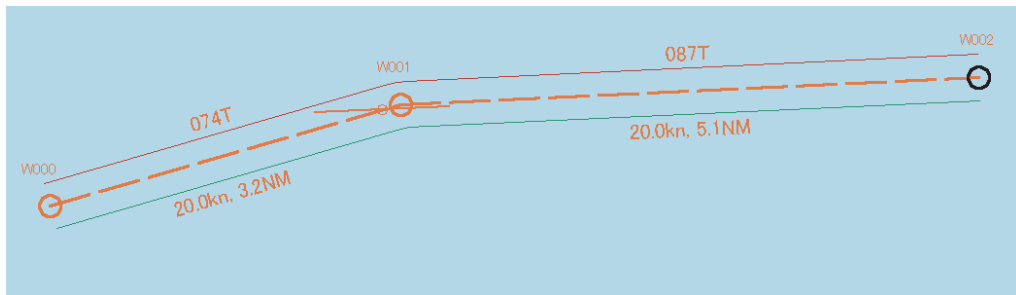
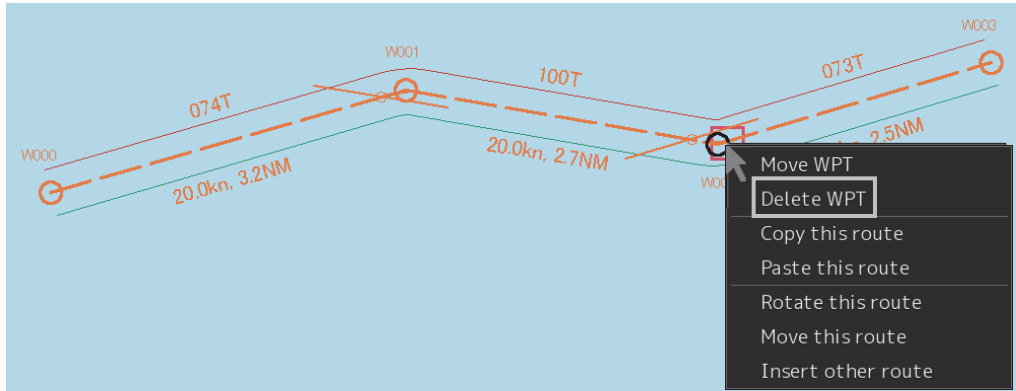

The WPT is deleted.

7.7.3.7 Copying and pasting a route on the context menu

A route can be copied and pasted on to another route file.

- 1 Click the right button on a WPT of the route to be copied.

The context menu is displayed.

- 2 Select [Copy this route] on the context menu.

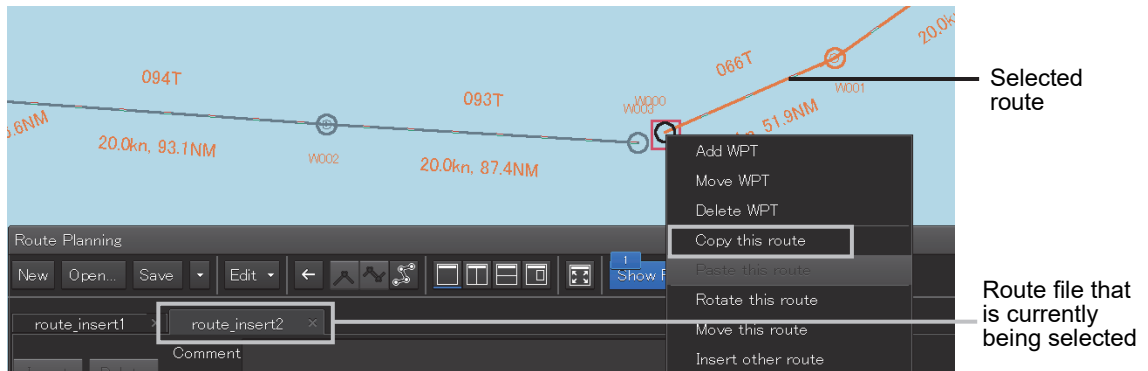

The route is copied.

- 3 Open the route file of the paste destination by switching the tab.

- 4 Select the route to be pasted and click the right button.

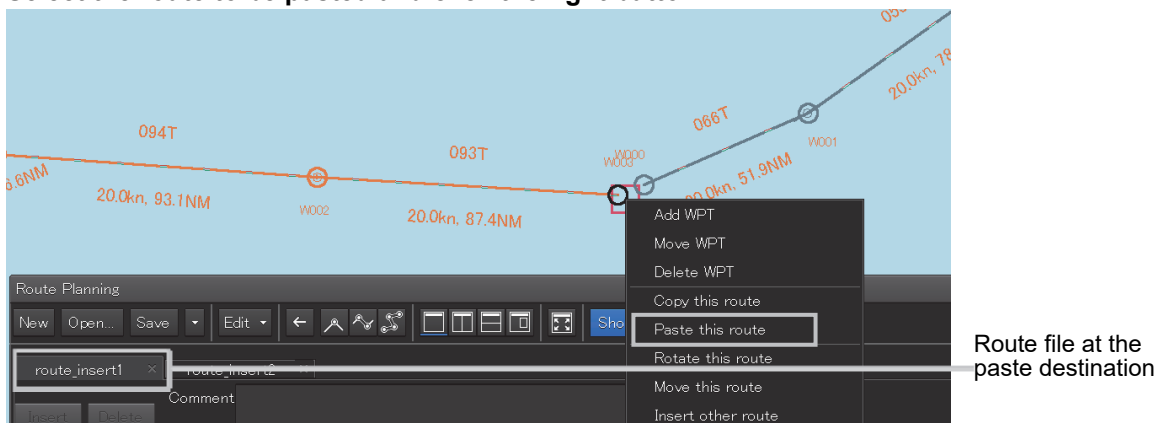

- 5 Click on [Paste this route] in the context menu.

The copied route is pasted to the selected route.

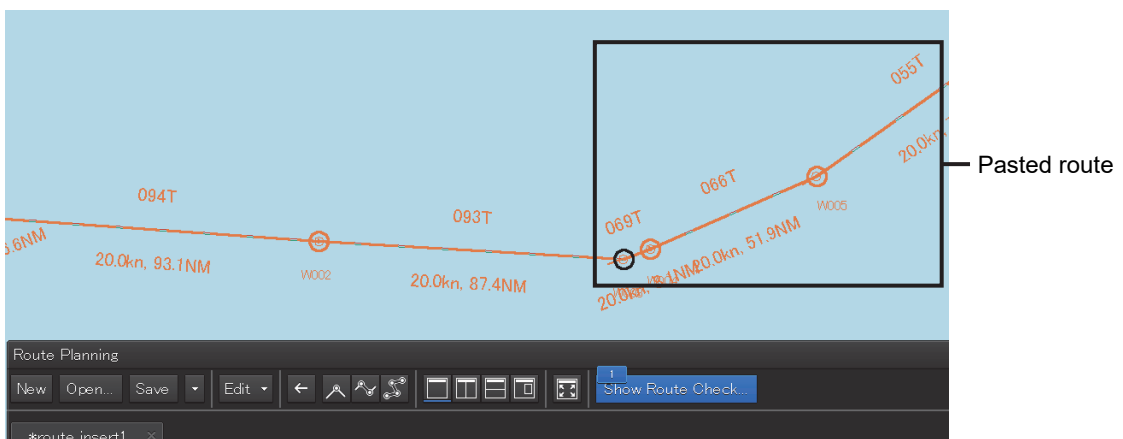

Note

At pasting, Course, Distance, Total Distance, ROT, TTG, and ETA are recalculated. When a Route planning error occurs as a result, an error message is displayed and insertion and pasting are not performed. For the error messages that are displayed, refer to "7.12 Error Messages that are Displayed when a Route is Created".

7.7.3.8 Rotating a route on the context menu

- 1 Click the right mouse button on the WPT No. that is used as the reference of rotation.
The context menu is displayed.
- 2 Click [Rotate this route] on the context menu.

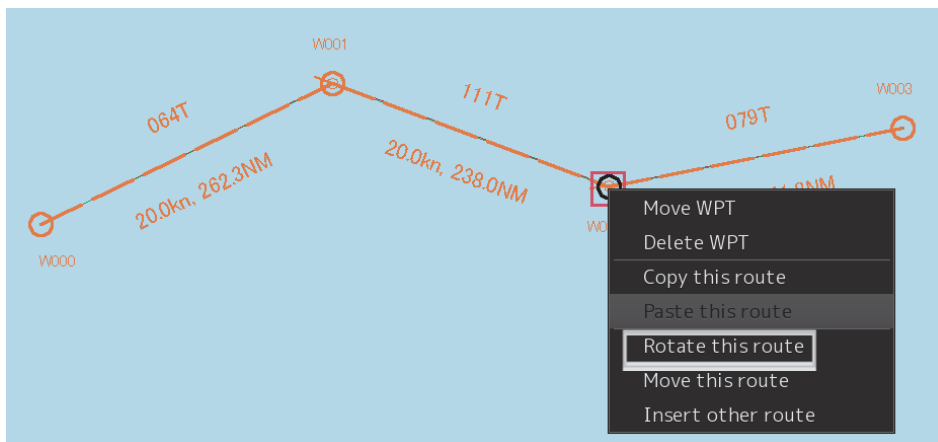

- 3 Rotate the route.

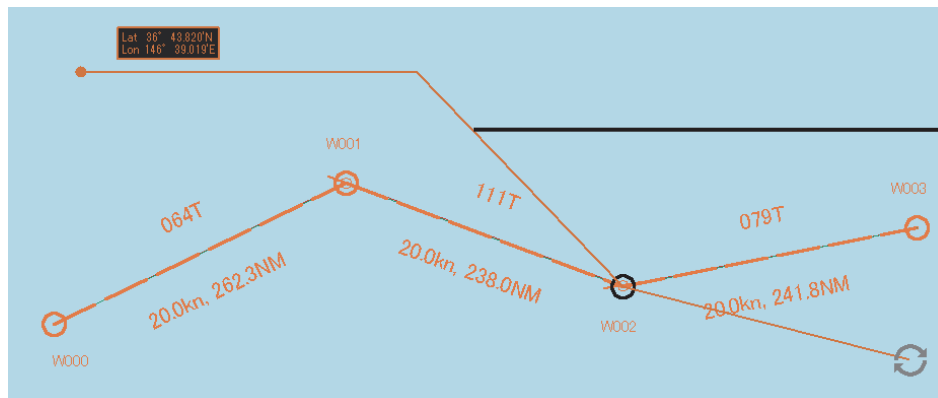

The route rotates based on the selected WPT

4 Click the mouse button.

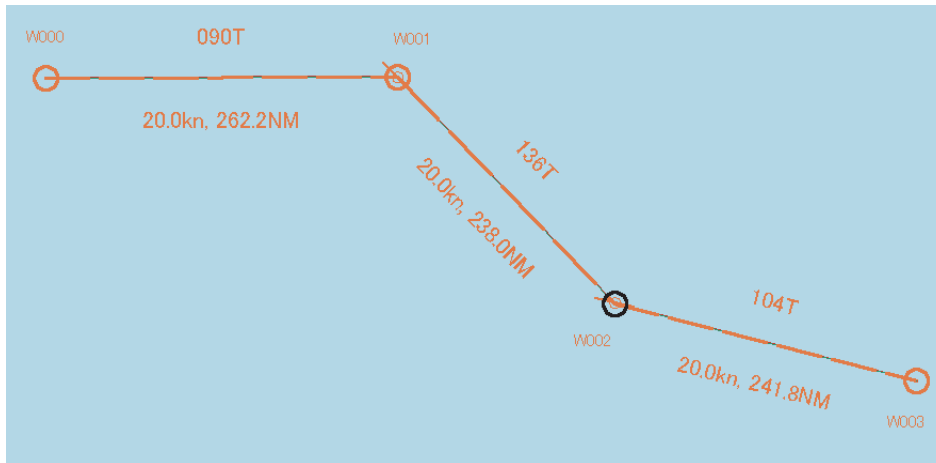

Cancelling the operation

The addition operation can be cancelled by clicking the right button instead of clicking at Step 4.

7.7.3.9 Moving a route on the context menu

- 1 Click the right mouse button on the WPT of any of the routes to be moved.
The context menu is displayed.
- 2 Click [Move this route] on the context menu.

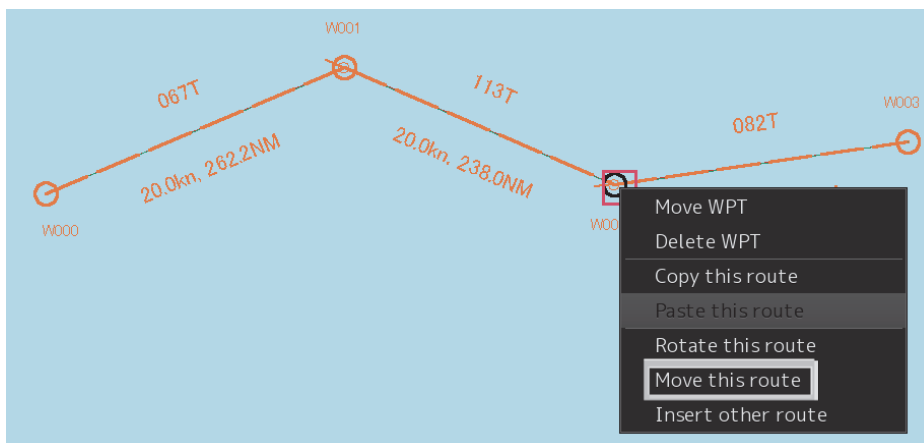

3 Move the route.

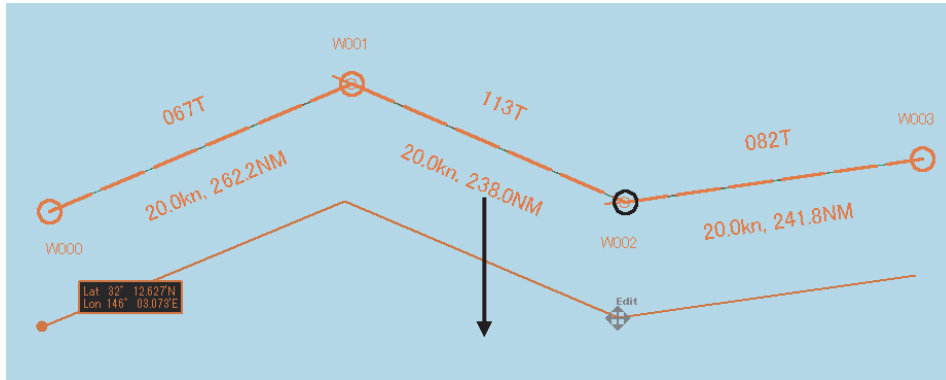

4 After positioning the route, click the mouse button.

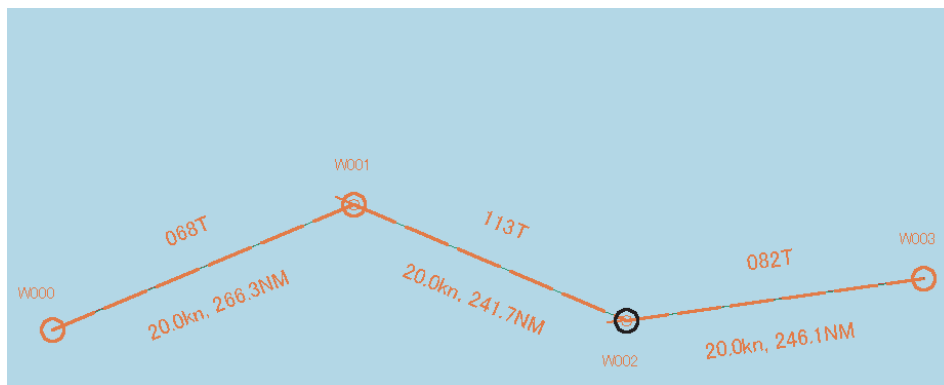

Cancelling the operation

The addition operation can be cancelled by clicking the right button instead of clicking at Step 4.

7.7.3.10 Inserting other route on the context menu

Insert the route of another file into the last WPT of the route.

- 1 Click the right mouse button on WPT No.

The context menu is displayed.

- 2 Click on [Insert other route] in the context menu.

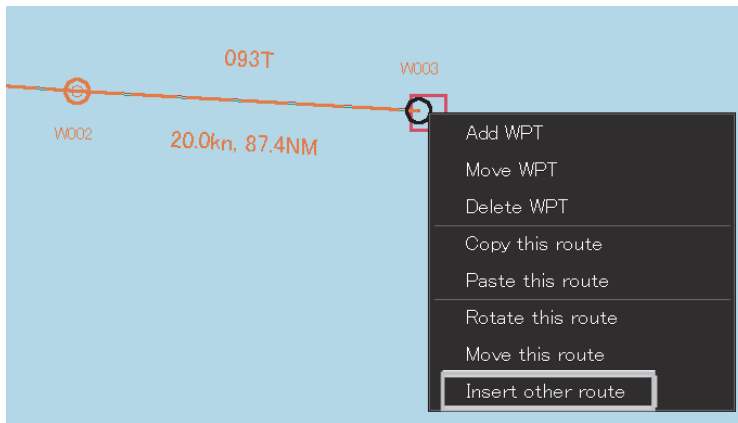

The [Inset other route] dialog is displayed.

- 3 Click on the route file to be inserted from the [Select Route] combo box.

- 4 Click on the [OK] button.

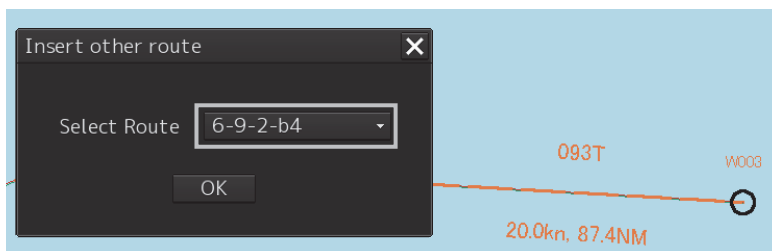

The route file is inserted.

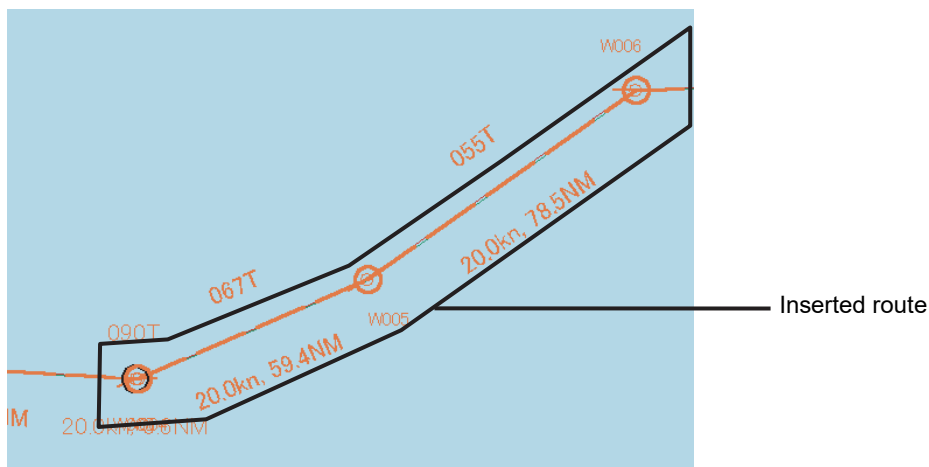

Note

When the range exceeded the insertion allowed range, an error message is displayed and the route will not be inserted.

7.7.3.11 Inserting WPT between WPTs on the context menu

- 1 Click the right mouse button on the leg between the WPTs within which WPT is to be inserted.

The context menu is displayed.

- 2 Click [Insert WPT] on the context menu.

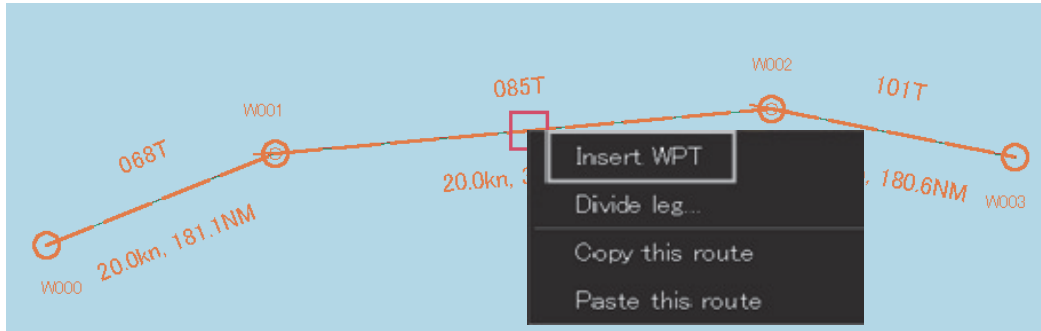

The cursor mode changes to the WPT insertion mode.

- 3 Move the cursor to the position in which WPT is to be inserted.

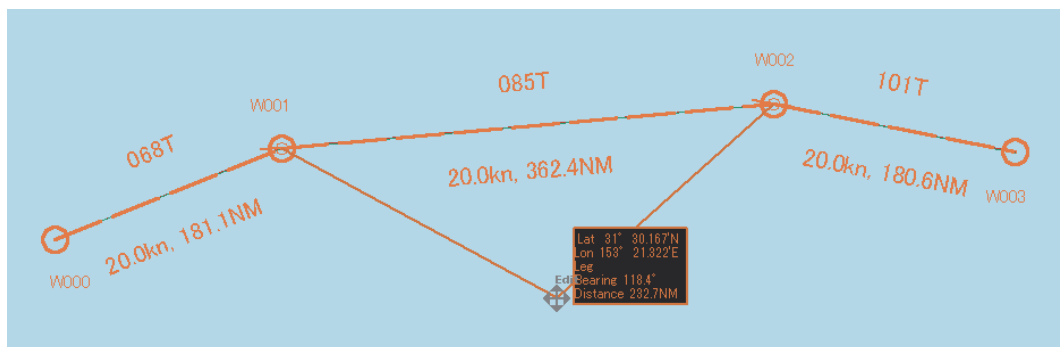

- 4 Click the mouse button.

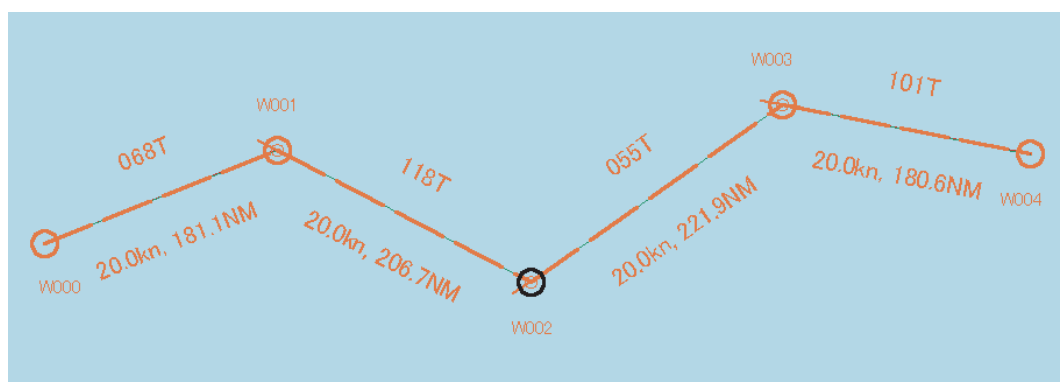

WPT is inserted.

Cancelling the operation

The insertion operation can be cancelled by clicking the right button instead of clicking at Step 4.

7.7.3.12 Dividing a leg on the context menu

- 1 Click the right mouse button on the leg of the route to be divided.

The context menu is displayed.

- 2 Click [Divide leg...] on the context menu.

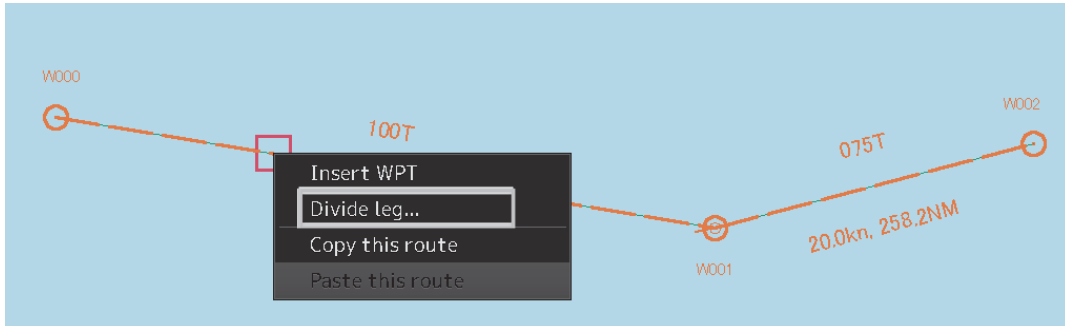

The [Divide Route] dialog box appears.

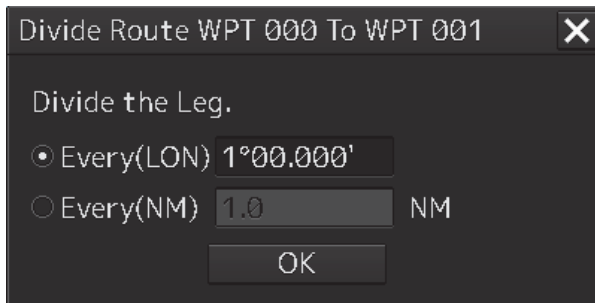

- 3 Input a division interval.

[Every(LON)] (longitude division)

- 1) Click on "Every(LON)".
- 2) Enter a longitude division interval.

[Every(NM)] (nautical mile division)

- 1) Click on "Every(NM)".
- 2) Enter a nautical mile division interval.

- 4 Click on the [OK] button.

The leg that was selected in Step 1 is divided in the unit specified in Step 3.

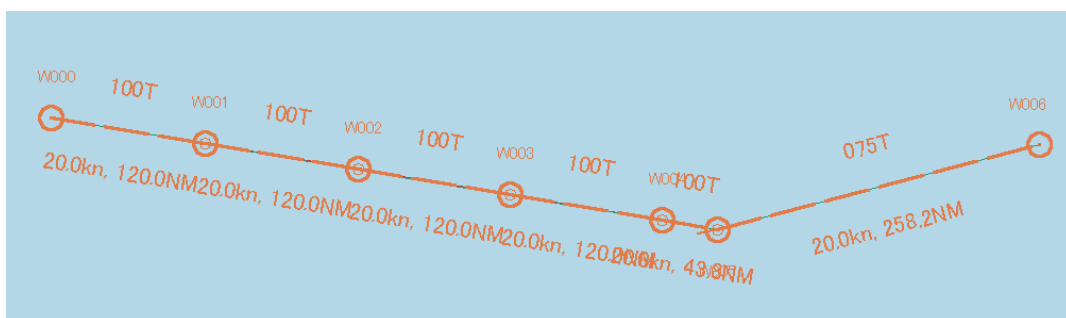

Note

When the total number of WPTs exceeds the maximum value of 511 as a result of leg division, leg division is executed within the range of 511 in the entire route.

7.7.3.13 Changing XTD (cross track limit) on the context menu

- 1** Click the right mouse button on XTD.
The context menu is displayed.
- 2** Click [Change XTL] on the context menu.

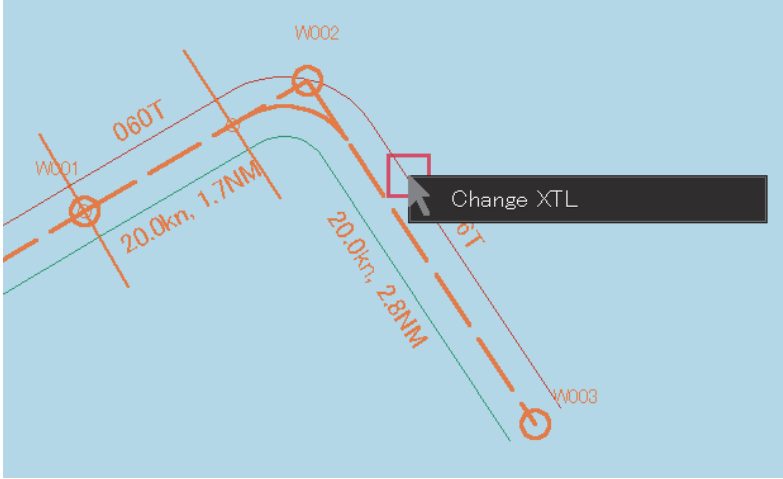

- 3** Change the width of XTD by moving the cursor.

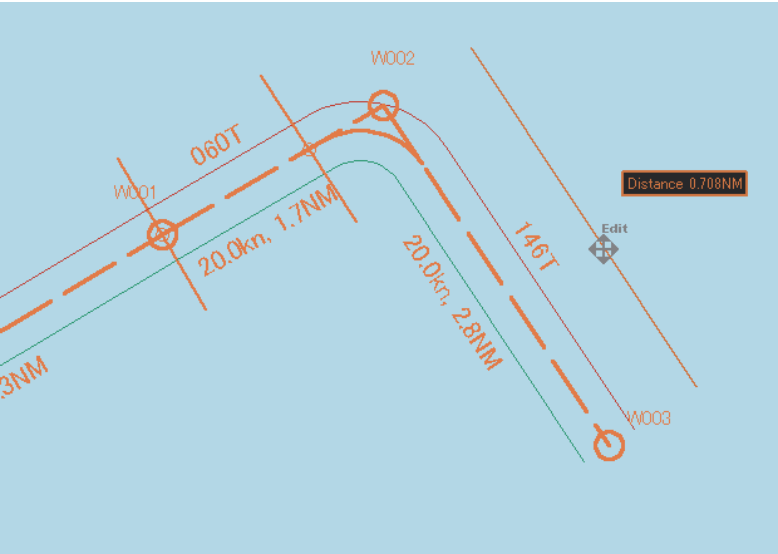

4 Click the mouse button.

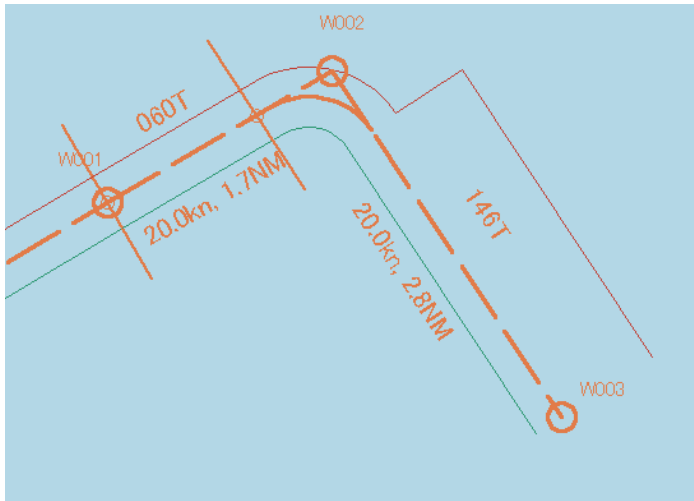

The XTD width is changed.

Cancelling the operation

The operation can be cancelled by clicking the right button instead of clicking at Step 4.

7.8 Creating an Alternate Route

An alternate route can be created by referencing the route that is currently displayed on the screen during sailing. An alternate route can be written over the existing route that is being monitored or can be saved by assigning a new name.

The following two charts indicate the original route and the modified alternate route. The diagram shows that an alternate route is created while the original route is displayed.

In the example below, the following WPTs are changed.

- W001 Position (shift)
- W002 (Insertion. As a result, the subsequent WPT numbers are incremented by 1.)
- W006 (1 WPT is added to the last WPT.)

Memo

The original route is displayed in red to distinguish it from the alternate route.

Original route

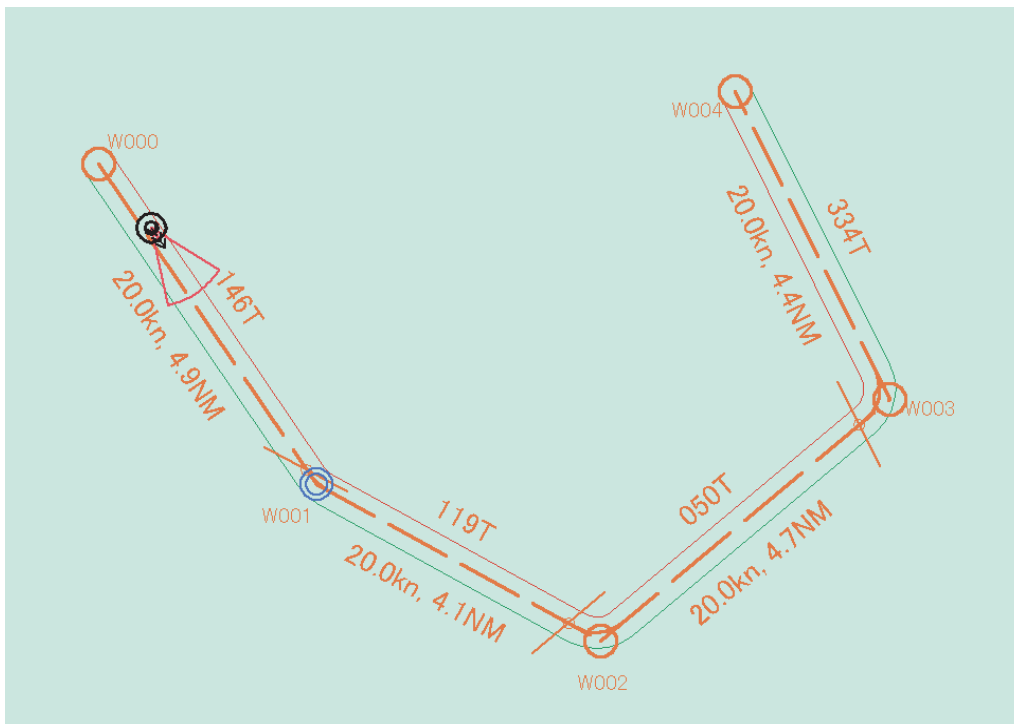

Original route and alternate route

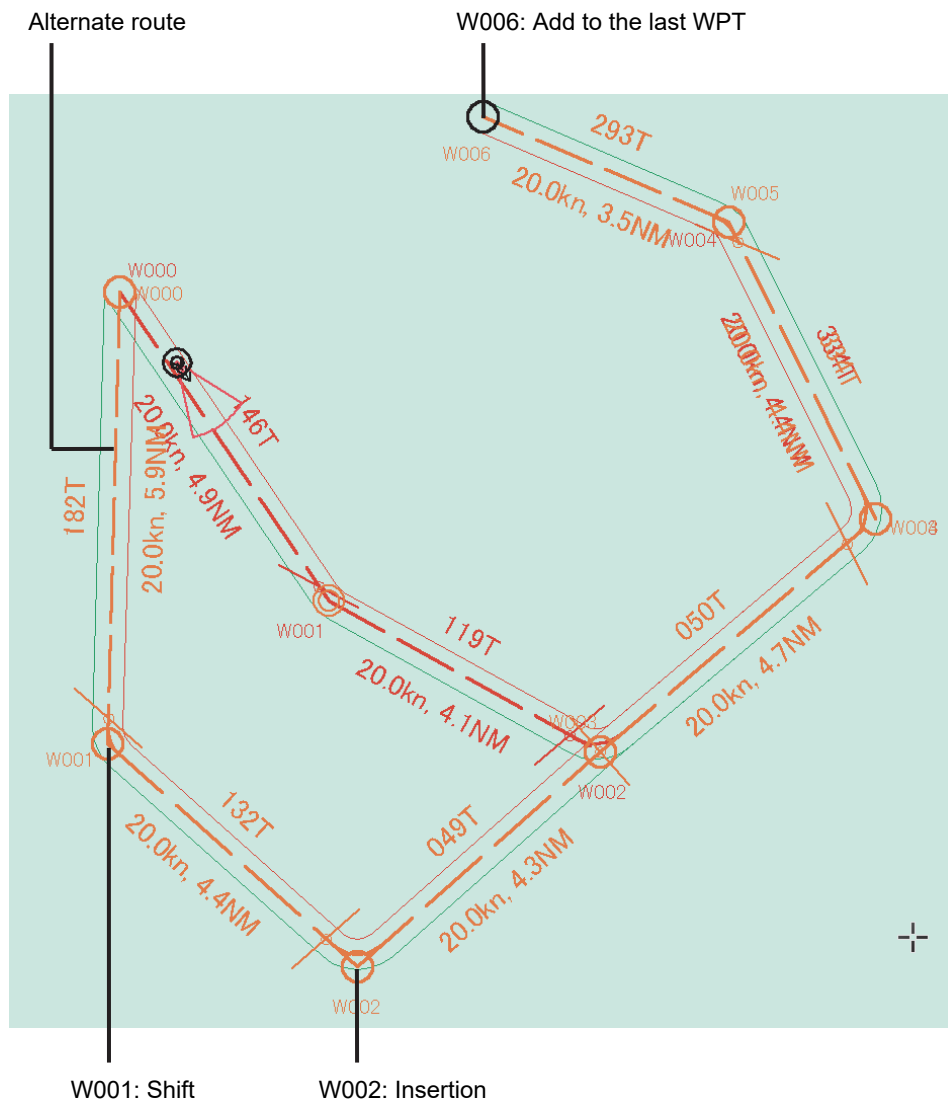

7.8.1 Creating an alternate route

- 1 Click the right button on the WPT of the route or leg that is being monitored.
The context menu is displayed.
- 2 Click on [Monitoring WPT xxx] or [Monitoring LEG xxx] in the context menu.

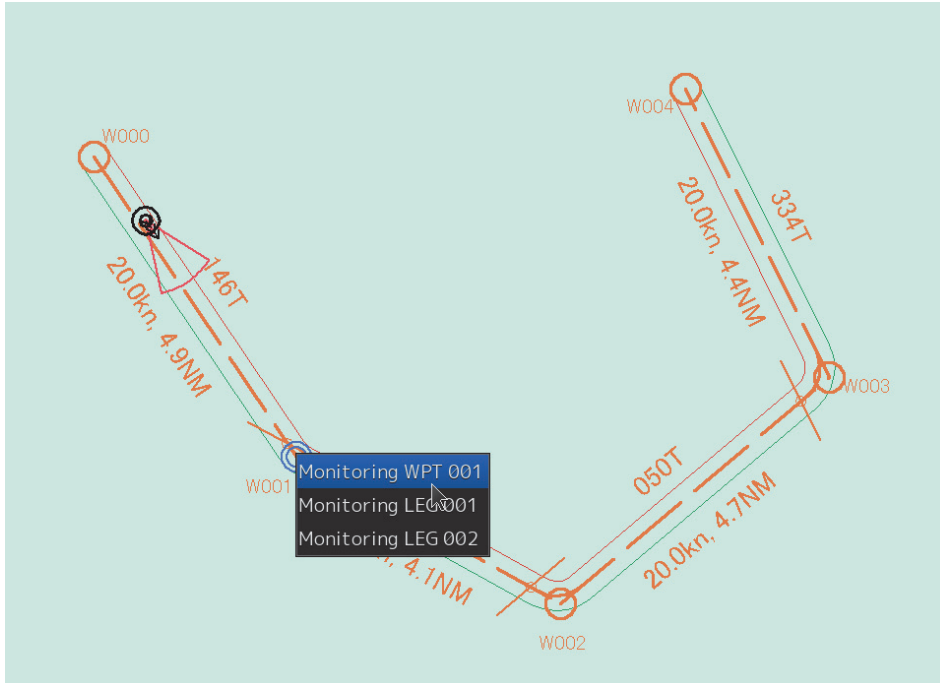

The context menu is displayed.

- 3 Click on [Edit this route] in the context menu.

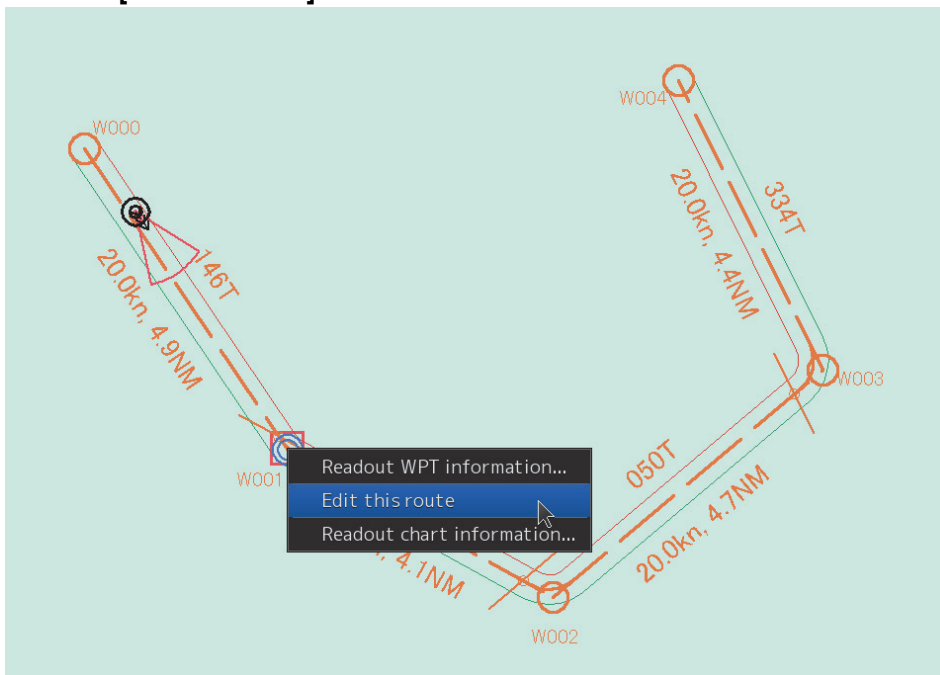

The [Route Planning] dialog is displayed.

- 4** For table editing, edit the route by using the same procedure as that from Step 3 in “7.6.4 Editing a Route in Table Editing”.
- 5** For graphic editing, click the right button on the WPT of the route or leg that is being monitored.
The context menu is displayed.
- 6** Click on [Planning WPT] or [Planning LEG] in the context menu.

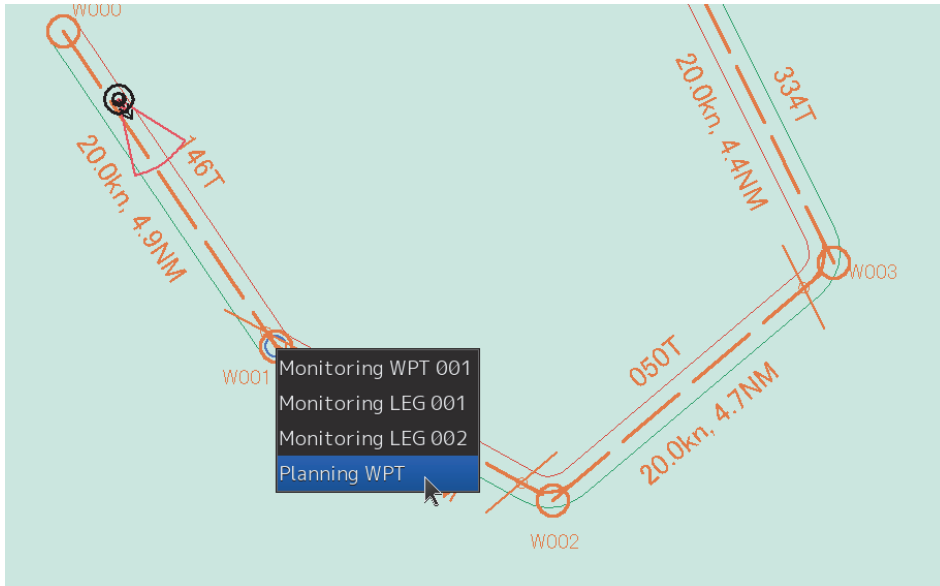

The context menu for editing WPT or leg is displayed.

- 7** Edit the route by using the same procedure as that from Step 3 in “7.7.3 Editing a route in graphic editing”.

7.8.2 Saving an alternate route

7.8.2.1 Overwriting without changing a file name

- 1** Click on the [Save] button.
A confirmation dialog is displayed.
- 2** Click on the [YES] button.

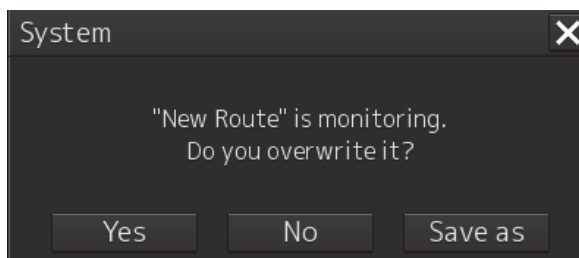

The alternate route is displayed and used instead of the original route.

Note

In this case, the name of the route that is being monitored remains unchanged. The original route file is cleared since it is overwritten.

7.8.2.2 Saving by assigning a name

- 1 Click on [Save as] of the route plan menu button on the route plan bar.**
The [Save as Route File] dialog is displayed.
- 2 Enter a new file name and click on the [Save] button.**
An alternate route is displayed and used instead of the original route.

Note

In this case, the name of the route that is being monitored changes to the file name that was input. The original route file remains.

7.9 Checking Route Data

Route data is constantly checked based on the safety standards and limits.

These items are checked on the [Check Route] dialog box.

The [Check Route] dialog box appears by clicking on the [Show Route Check] button on the Route Planning bar.



7.9.1 Checking a route based on the safety standards

The result of safety check is displayed on the "Safety check" tab.

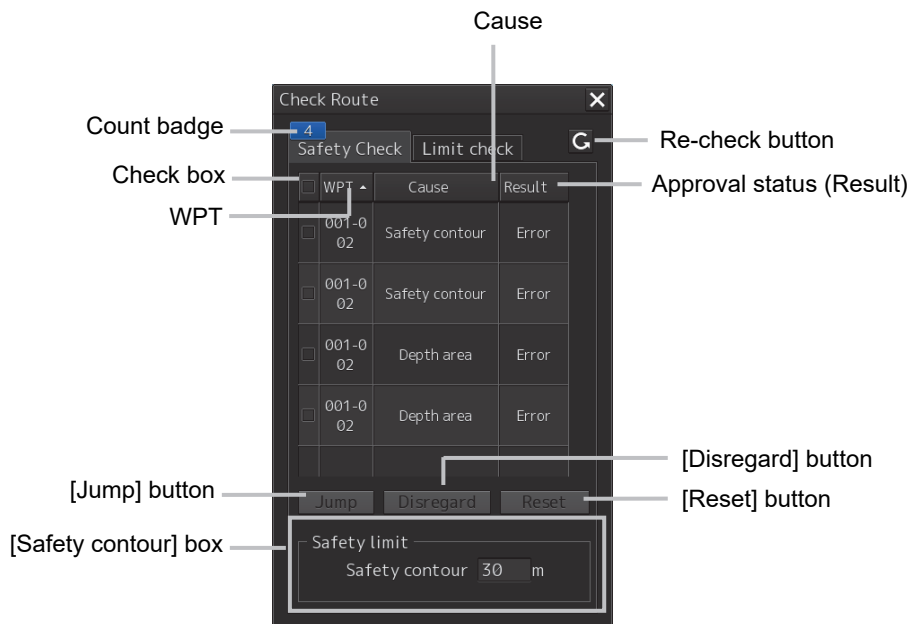

When safety errors are detected, the number of errors is displayed on the count badge. When the error count exceeds 999, "More" is displayed instead of the count.

The list of Cause and Result of the errors that were detected is displayed for each WPT prior to and following the error occurrence point.

The following causes are displayed.

| Cause |
|------------------------------------|
| SpeConAre(Traffic separation zone) |
| SpeConAre(Traffic crossing) |
| SpeConAre(Traffic roundabout) |
| SpeConAre(Traffic precautionary) |
| SpeConAre(Two way traffic) |
| SpeConAre(Deeper water route) |

| |
|--|
| Cause |
| SpeConAre(Recommended traffic lane) |
| SpeConAre(Inshore traffic zone) |
| SpeConAre(Fairway) |
| SpeConAre(Restricted area) |
| SpeConAre(Caution area) |
| SpeConAre(Offshore production area) |
| SpeConAre(Military practice area) |
| SpeConAre(Seaplane landing area) |
| SpeConAre(Submarine transit area) |
| SpeConAre(Canal) |
| SpeConAre(Fishing ground) |
| SpeConAre(Fishing prohibited) |
| SpeConAre(Pipeline area) |
| SpeConAre(Cable area) |
| SpeConAre(Anchorage area) |
| SpeConAre(Anchorage prohibited) |
| SpeConAre(Dumping ground) |
| SpeConAre(Cargo transshipment area) |
| SpeConAre(Incineration area) |
| SpeConAre(Specially protected area) |
| SpeConAre(Safety contour) |
| SpeConAre(Coast line) |
| SpeConAre(Obstruction) |
| SpeConAre(Under water rock) |
| SpeConAre(Wreck) |
| SpeConAre(Spoil ground) |
| SpeConAre(Sensitive sea area) |
| SpeConAre(Archipelagic sea lane) |
| SpeConAre(Marine farm/aquaculture) |
| AtoN |
| Vertical Clearance |
| Hazard |
| Caution Object |
| Warning object |
| Alarm Object |
| Sounding |
| PSSA (Particularly Sensitive Sea Area) |
| Areas to be avoided |

memo

When the S63 chart and the C - MAP chart are used in combination with the safety check function, the S63 chart takes precedence.

Updating an error list

By clicking on the Re-check button, the latest error information is displayed by rechecking the information.

Sorting error display

By clicking on any of the items on the title line, error display can be sorted based on the item. A sort mark (▲ or ▼) is displayed on the title of the selected item.

Whenever an item is clicked on, the error display is sorted based on the ascending (▲) or the descending (▼) order.

Selecting an error to be processed

Select the check box of the error to be processed. To select all the errors, select the check box on the title line.

When the [Jump] button is clicked on, control jumps to the occurrence point of the error that was selected on the error list.

Ignoring an error

Click on the [Disregard] button. To restore the error that was once ignored, click on the [Reset] button.

Checking an error target on the list

When an error is detected, the WPT under which the error occurred is highlighted in red.

| WPT No. | Name | Position | | Leg | | Sail | XTD | | Arrival Radius | Turning Radius | Planned Speed | ROT | ETA [YYYY-MM-DD hh:mm] | Time Zone | TWOL [Days hh:mm] | Dis |
|---------|------|-------------|-------------|--------|----------|------|--------|--------|----------------|----------------|---------------|-----------|---------------------------|-----------|----------------------|-----|
| | | LAT | LON | BWW | Distance | | PORT | STBD | | | | | | | | |
| 0 | | 32°30.110'S | 60°59.942'E | | | | | | | | | | 2013-12-11 05:52 | 00:00 | | |
| 1 | | 32°26.329'S | 60°58.790'E | 345.5° | 3.9NM | RL | 0.20NM | 0.20NM | 0.50NM | 0.50NM | 15.0kn | 28.6°/min | 2013-12-11 06:07 | 00:00 | 00 Days 00:15 | |
| 2 | | 32°27.492'S | 61°00.411'E | 130.2° | 1.8NM | RL | 0.20NM | 0.20NM | 0.50NM | 0.50NM | 20.0kn | 38.2°/min | 2013-12-11 06:13 | 00:00 | 00 Days 00:05 | |
| 3 | | | | | | | | | | | | | | | | |

Checking an error target on the route

When an error is detected, the [Safety contour Alert] object in the Alert List is displayed in red and [Navigational Hazard Alert] and [Area Alert] are highlighted in yellow.

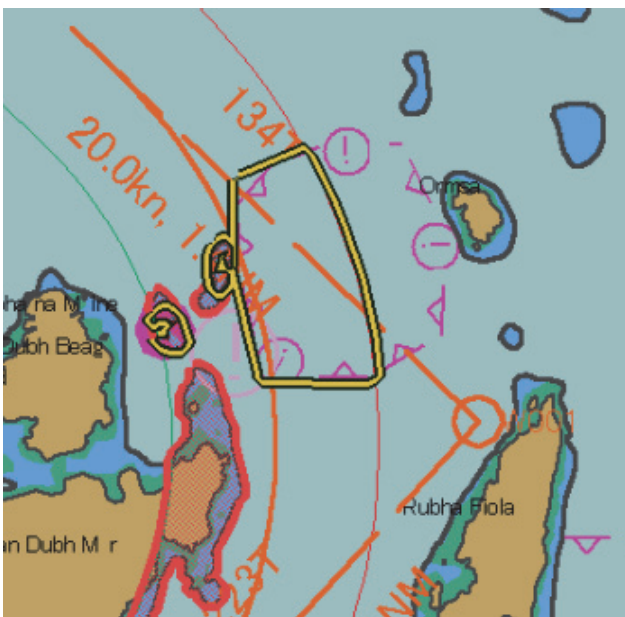
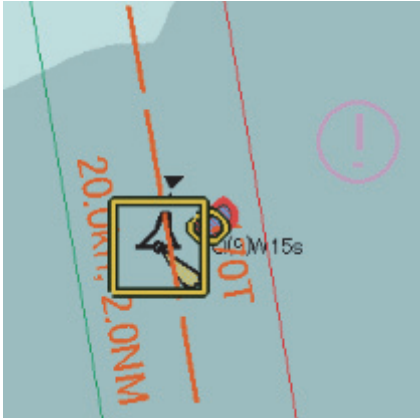

When error display is clicked on the error list, the error target are highlighted.

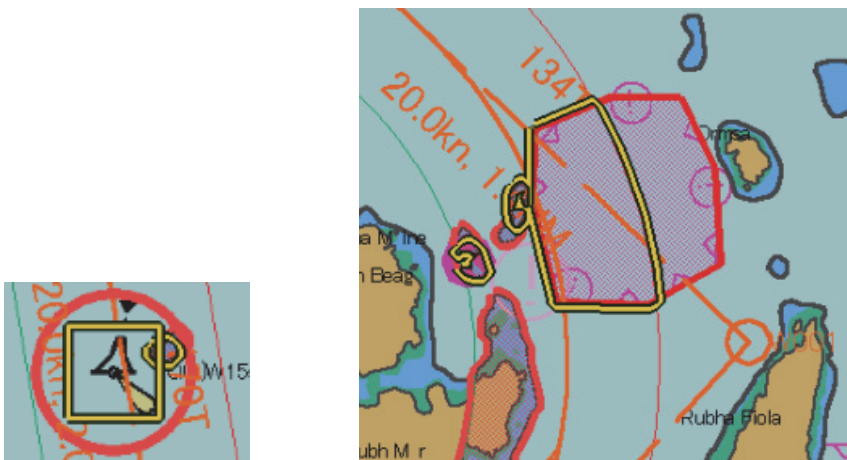

7.9.2 Checking a route based on the limits

The result of limit check is displayed on the [Limit check] tab.

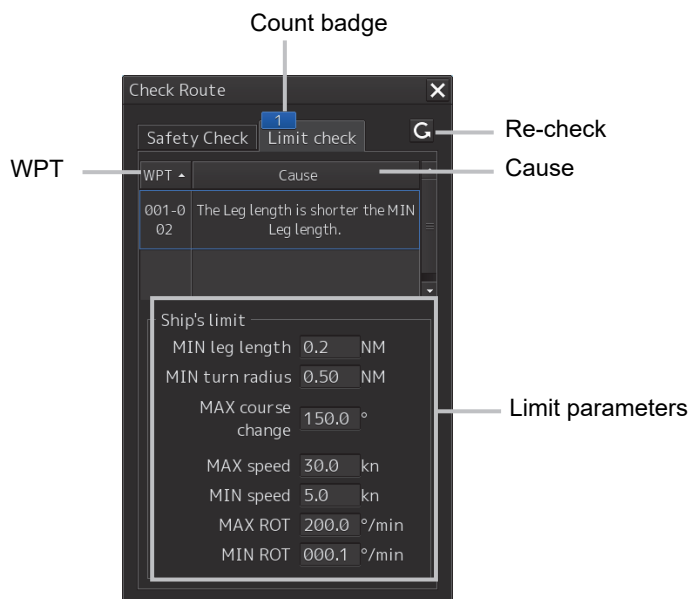

When limit errors are detected, the error count is displayed on the count badge. When the error count exceeds 999, "More" is displayed instead of the count.

The cause of the error that was detected is displayed for each of WPTs prior to and following the error occurrence point.

The following causes are displayed.

| Cause |
|---|
| The planned radius is beyond the MAX turn radius. |
| The planned radius is under the MIN turn radius. |
| The course angle of leg is beyond the MAX course angle. |
| The planned speed is beyond the MAX planned speed. |
| The planned speed is under the MIN planned speed. |
| The planned ROT is beyond the MAX ROT. |
| The planned ROT is under the MIN ROT. |
| The Leg length is shorter the MIN Leg length. |
| The straight route cannot be created. |

Updating error display

By clicking on the re-check button, the latest error information is displayed by rechecking the information.

Sorting error display

By clicking on any of the items on the title line, error display can be sorted based on the item. A sort mark (▲ or ▼) is displayed on the title of the selected item.

Whenever an item is clicked on, the error display is sorted based on the ascending (▲) or the descending (▼) order.

Verifying an error target on the list

When an error is detected, WPT of the error target is highlighted in yellow.

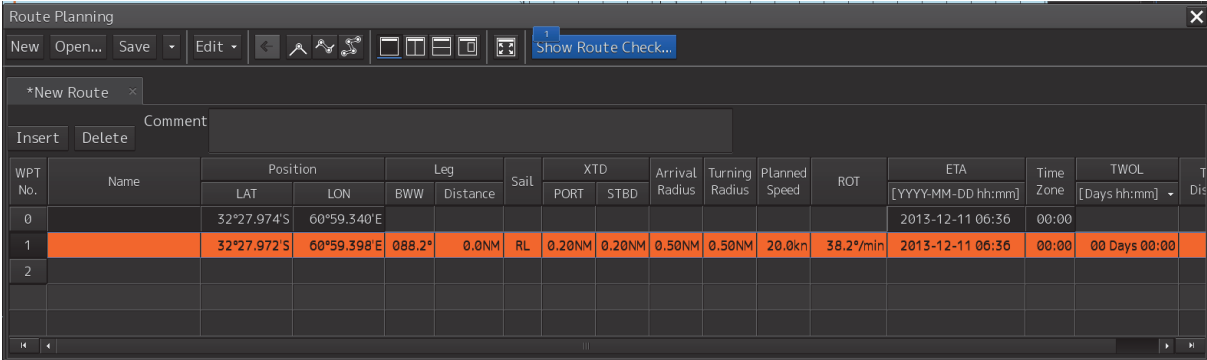

7.10 Navigation Calculation Function

This section describes the function that supports the distance and bearing calculation that are required for navigation.

| Turning Radius | Planned Speed | ROT | ETA | Time Zone | TWOL | Total Distance |
|----------------|---------------|-----------|--------------------|-----------|---------------|----------------|
| | | | [YYYY-MM-DD hh:mm] | | Days hh:mm] ▾ | |
| | | | 2017-02-22 04:34 | 00:00 | | |
| 0.50NM | 20.0kn | 38.2°/min | 2017-02-22 10:25 | 00:00 | 00 Days 05:50 | 116.9NM |
| 0.50NM | 20.0kn | 38.2°/min | 2017-02-22 10:52 | 00:00 | 00 Days 00:26 | 125.9NM |
| 0.50NM | 20.0kn | 38.2°/min | 2017-02-22 16:11 | 00:00 | 00 Days 05:18 | 232.3NM |
| 0.50NM | 20.0kn | 38.2°/min | 2017-02-22 16:15 | 00:00 | 00 Days 00:04 | 233.7NM |

7.10.1 ROT (Rate of Turn)

ROT is automatically calculated from the planned ship's speed and the turn radius and displayed on [ROT].

7.10.2 ETA (Estimated Time of Arrival)

ETA is automatically calculated from the WPT position, planned ship's speed, and time zone and is displayed on [ETA].

When ETA includes a date other than the current date, Viewing Does Not Include Current Date is displayed in Permanent Information because displaying of a date-dependent object is executed.

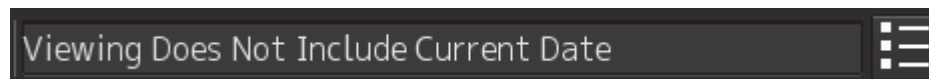

Detailed wording which each ETA's range is displayed within one day, each one or more is different.

When the ETA range is one day or less

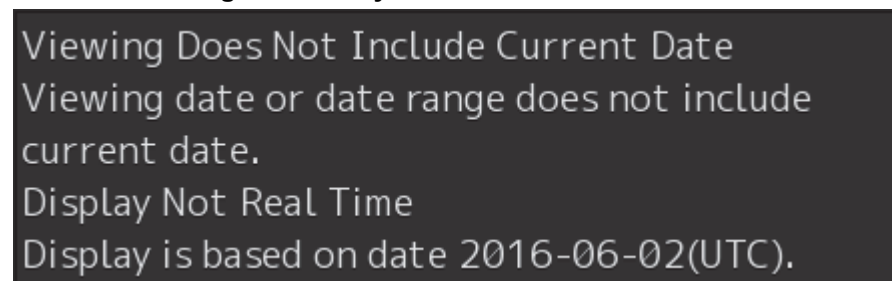

When the ETA range is greater than one day

Viewing Does Not Include Current Date
Viewing date or date range does not include current date.
Display Not Real Time
Display is based on viewing date range from 2016-06-01(UTC) to 2016-06-02(UTC).

* For the date-dependent objects, refer to the following.

Section 11 - 11.5 Displaying a date-dependent object – Displaying an indication of duration specification.

7.10.3 TWOL (Time to Go)

TTG is automatically calculated from the WPT position and planned ship's speed and displayed on [TWOL].

A display format can be selected from the list that is displayed by clicking on the TWOL title.

[Days hh:mm]

01Days 23:59

[hhhh:mm]

9999:59

Memo

In the navigation calculation function, each value is calculated using CCRP as a reference point.

7.11 Importing/Exporting a Route File

By using the [Import] or [Export] dialog box, the route file that was created can be imported/exported. The dialog box can be displayed as follows.

- 1 Click on the Route Planning menu button.
- 2 Select [Import] or [Export] from the list that is displayed.
The [Import] or [Export] dialog box appears.

7.11.1 Importing a route file

- 1 Specify the "Drive", the "Folder", the "File name", and the "File Type" that stores the file to be imported.
- 2 Click on the [OK] button.
The route file that is selected can be imported.
Press the [X] button to cancel the importing of a file.

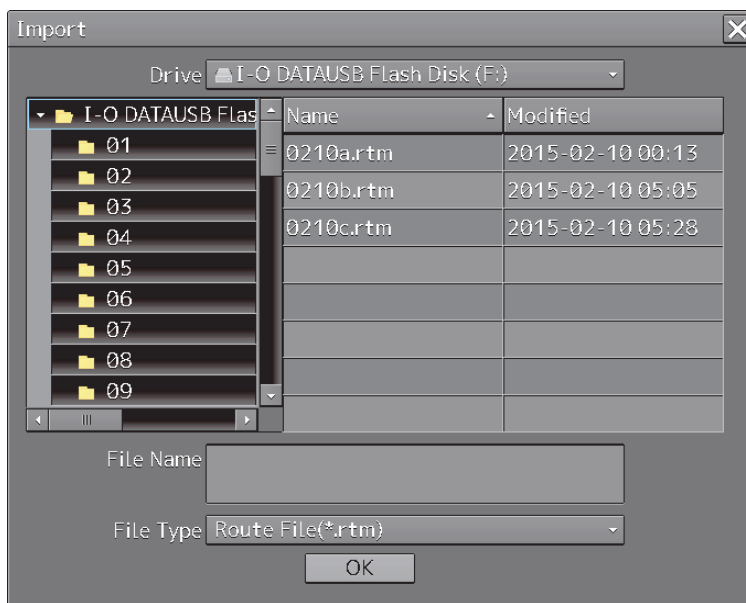

Note

The file type of the file to be imported can be selected in the [File Type] combo box. The file types that can be imported are as follows.

.rtn: Displays a route file (normal).

This file is used for ECDIS (JAN-701B/901B) and Chart Radar (JMA-900B)

.rta: Displays a route file (TCS route).

This file is used for ECDIS (JAN-701B/901B) and Chart Radar (JMA-900B)

.rtm: Displays a route file used in this equipment.

.rtz: Displays a route file (the route plan exchange format specified in IEC61174). RTZ version 1.0 and RTZ version 1.1 are supported.

.csv: Displays a route file in CSV format.

*(Wildcard): Displays all the files that can be imported.

When importing a route file created by another company's device, be sure to check the route file with the rout planning function before using it. If the XTD, Arrival Radius, PlanSpeed, Sail, Turn Radius, and Time Zone of the route file to be imported contain values outside the set range, the default values will be replaced and imported. (If a csv format route file containing values outside the set range is imported, an import error will occur. The value does not replace the default value.)

7.11.2 Exporting a route file

- 1 Specify the "Drive", the "Folder", the "File name", and the "File Type" that stores the file to be exported.

- 2 Click on the [OK] button.

The route file that is currently opened is exported.

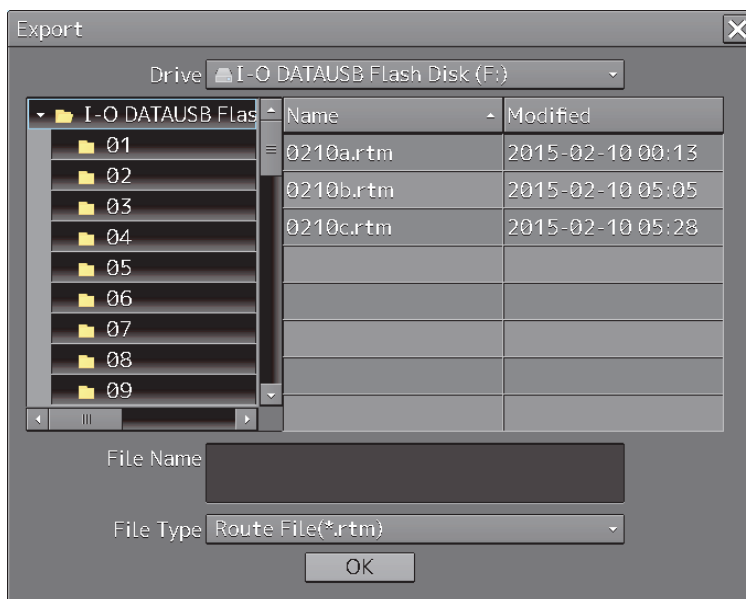

Press the [X] button to cancel the exporting of a file.

**Note**

When .rtz is selected, the route file will be exported in RTZ version 1.0 format.

7.12 Error Messages that are Displayed when a Route is Created

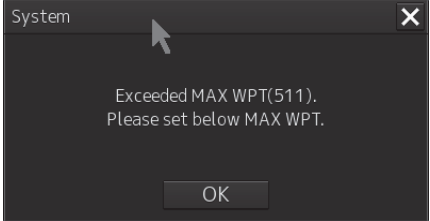
When a route is created, the following error messages may be displayed, disabling execution of the specified operation.

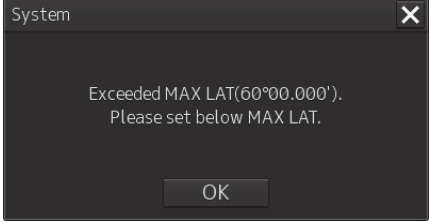
| Error message | Status |
|--|--|
|  | <p>The total number of WPTs exceeded the upper limit (511).</p> |
|  | <p>The leg length exceeded the maximum value (longitude 150°).</p> |
|  | <p>The latitude exceeded the latitude upper limit.</p> |

Section 8 Route Monitoring

8.1 Route Monitoring

The route monitoring function enables monitoring of the position of own ship, heading, and ship speed, and calculation of an expected time of arrival using the route created in route planning.

Memo

For monitoring a route, it is necessary to create a route file or copy a route file in route planning in advance.

For the details of route planning, refer to "Section 7 Route Planning".

8.1.1 Starting route monitoring

- 1 Click on the [Menu] button on the left toolbar.

The menu is displayed.

- 2 Click on the [Route Monitoring] button on the menu.

The [Route Monitoring] dialog box appears.

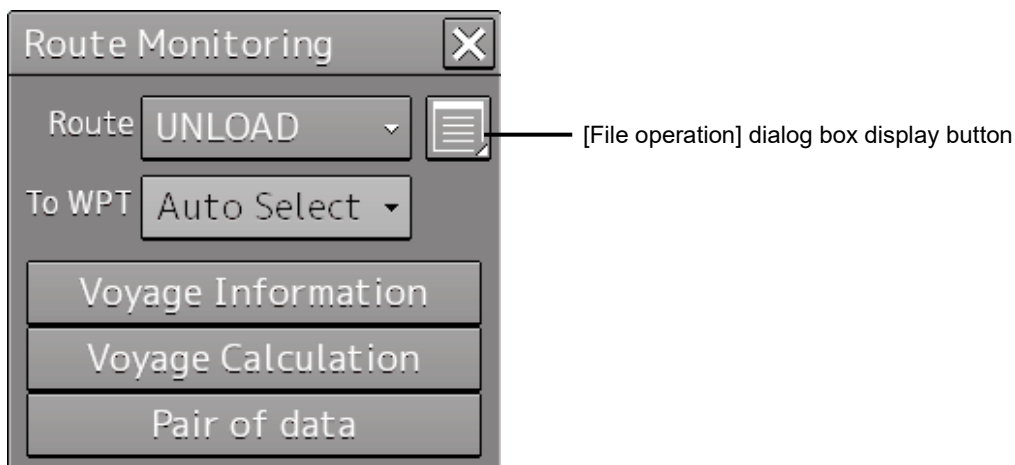

- 3 Select a required route file.

[Selecting from the [Route] combo box]

- 1) Click on the [Route] combo box.
- 2) Select a required route.

[Selecting from a route file list]

- 1) Click on the [File operation] dialog box display button.
- 2) Select a required file from the list of the [File operation] dialog box.

About the [File operation] dialog box, refer to "8.2 Selecting and Deleting Route Files"

- 3) Click on the [Open] button.

Note

It is possible to select only the route for which the turn is completed before the next turn occurs.

Automatic safety checking after loading a route

When a route file is loaded, safety checking is executed automatically.

When an error is detected, the [Safety Contour Alert] object is displayed in red and [Navigational Hazard Alert] and [Area Alert] are highlighted in yellow.

4 Select a WPT to which the ship is to travel. A WPT can be selected automatically or manually.**[Automatic selection]**

The nearest WPT from the own ship's position is selected automatically.

- 1) Open the next WPT list by clicking on the [To WPT] combo box.
- 2) Select [AUTO Select].

[Manual selection]

Select a WPT manually.

- 1) Open the next WPT list by clicking on the [To WPT] combo box.
- 2) Click on a required WPT .

8.1.2 Ending route monitoring

1 Click on the [Menu] button on the left toolbar.

The menu is displayed.

2 Click on the [Route Monitoring] button on the menu.

The [Route Monitoring] dialog box appears.

3 Click on the [Route] combo box.**4 Click on [UNLOAD].**

8.2 Selecting and Deleting Route Files

Selection of the route to be displayed and deletion of obsolete route files are enabled on the [File operation] dialog box.

Use the following procedure to open the [File operation] dialog box.

- 1 Click on the [Menu] button on the left toolbar.**
The menu is displayed.
- 2 Click on the [Route Monitoring] button on the menu.**
The [Route Monitoring] dialog box appears.
- 3 Click on the [File operation] dialog box display button.**
The [File operation] dialog box appears.

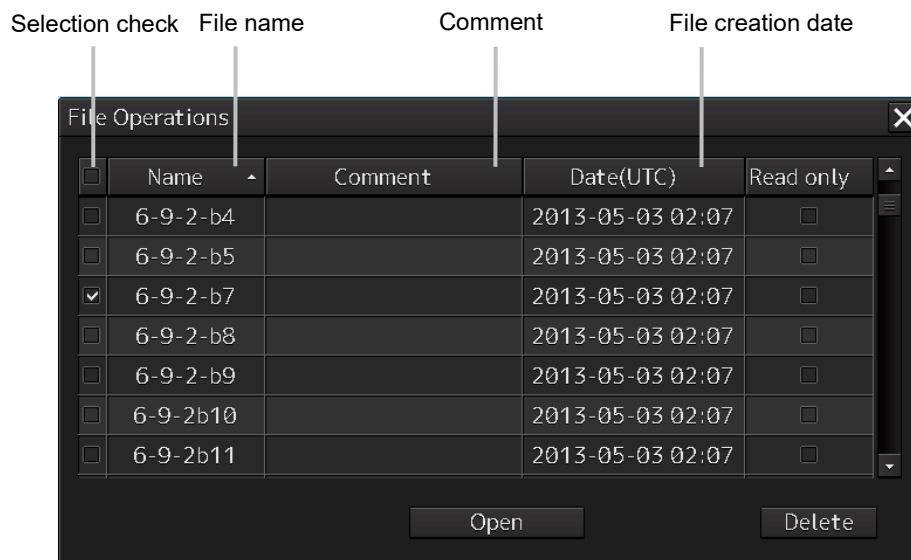

8.2.1 Selecting a route to be displayed

- 1 Select the selection check box of the route file to be displayed.**
When [Name] is clicked on, ▼ is displayed. Whenever ▼ is clicked on, the file display sequence changes to the ascending/descending sequence based on the names.
- 2 Click on the [Open] button.**

8.2.2 Deleting a route file

- 1** Click the selection check of the route file to be deleted.
- 2** Click on the [Delete] button.
A message dialog box is displayed as to whether the deletion is to be executed.
- 3** When executing deletion, click on the [Yes] button. To cancel deletion, click on the [No] button.

Note

The file of the route that is currently monitored or the route that is used for cannot be deleted.
The following message dialog box appears.

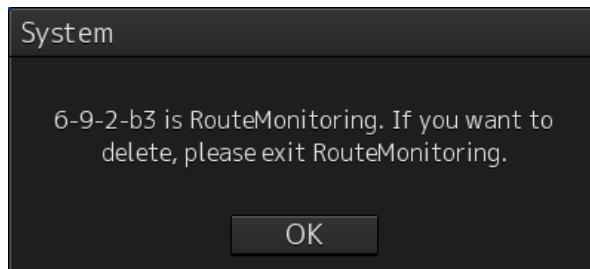

Close the dialog box by clicking on the [OK] button.

8.3 [Voyage Information] (Voyage Monitoring Information) Dialog Box

Note

In case of JAN-7201S/9201S, automatic sailing function and S-Joy function are not available by function restriction. Therefore the informations for their functions are not available.

The [Voyage Information] (voyage monitoring information) dialog box is used to monitor voyage statuses.

In addition to voyage monitoring, execution of course change and termination of automatic navigation can also be performed.

Use the following procedure to open the [Voyage Information] dialog box.

1 Click on the [Menu] button on the left toolbar.

The menu is displayed.

2 Click on the [Route Monitoring] button on the menu.

The [Route Monitoring] dialog box appears.

3 Click on the [Voyage Information] button.

The [Voyage Information] dialog box appears.

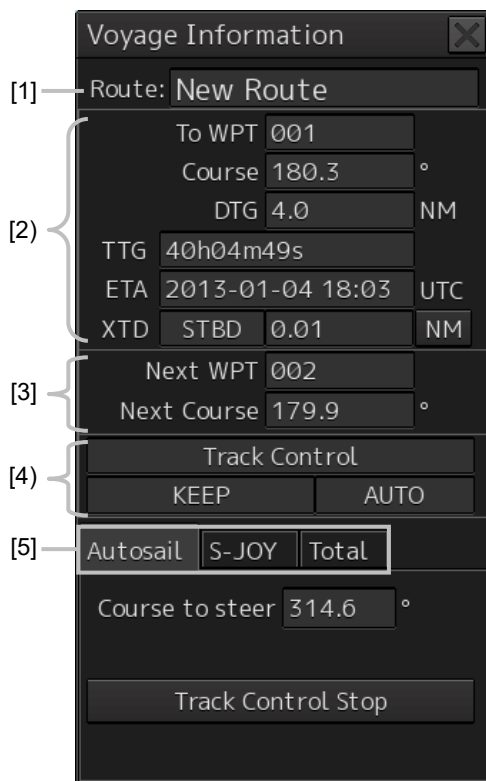

[1] Route name display

A file name of the route that is being monitored is displayed.

[2] To WPT information

The To WPT information that was selected in the [Route Monitoring] dialog box is displayed.

| | | | |
|--------|------------------|------|-----|
| To WPT | 001 | | [a] |
| Course | 180.3 | ° | [b] |
| DTG | 4.0 | NM | [c] |
| TTG | 39h59m39s | | [d] |
| ETA | 2013-01-04 18:03 | UTC | [e] |
| XTD | STBD | 0.01 | [h] |
| | | | [f] |
| | | | [g] |

[a] [To WPT] (To WPT number)

Displays a To WPT number.

[b] [Course] (Angle of own ship - To WPT)

Displays a bearing between the WPTs (To WPT bearing from the previous To WPT).

[c] [DTG] (Distance of own ship - To WPT)

Displays the distance between own ship and To WPT.

[d] [TTG] (Expected traveling time)

Displays an expected traveling time to reach the position indicated by To WPT.

[e] [ETA] (Expected time of arrival)

Displays the expected time of arrival at the position indicated by To WPT.

[f] Cross track direction

Displays a cross track direction of the own ship.

When the own ship is cross-tracked on the right side, [STBD] is displayed and when the own ship is cross-tracked on the left side, [PORT] is displayed.

[g] Cross track distance

Displays a cross track distance of the own ship.

[h] Cross track distance unit switching button

Switches the display unit of a cross track distance. Whenever the button is clicked on, the unit is switched to "m" or "NM".

[3] Next WPT information

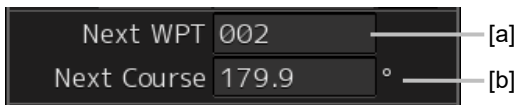

[a] [Next WPT] (Next WPT number)

Displays a Next WPT number.

[b] [Next Course] (Leg bearing of Next WPT)

Displays a leg bearing of the Next WPT.

[4] Automatic sailing information

This section displays the status of Auto Pilot that is installed.

Note
In case of JAN-7201S/9201S, automatic sailing function is not available by function restriction.



[a] Automatic sailing mode

Displays an automatic sailing mode.

| Display | Status |
|-----------------|---|
| No display | A/P (Auto Pilot) non-connection setting or automatic sailing alert is occurring |
| Track Control | The A/P steering mode is set to Track Control. |
| Heading Control | The A/P steering mode is set to Heading Control. |
| Manual | The A/P steering mode is set to Manual. |
| Override | Ship avoiding operation in progress |

Memo
 The display contents vary depending on the auto pilot that is installed. For the details, refer to the Auto Pilot Instruction Manual.

[b] Control mode

Displays a control mode of automatic sailing.

| Display | Status |
|---------------|---|
| No display | Automatic sailing inactive |
| KEEP | Automatic sailing/maintaining the course |
| DIRECT | Auto sailing/Direct to Waypoint selected |
| TURN | Automatic sailing/turning (TCS category C) |
| AVOID | Auto sailing/ Ship avoiding operation in progress |
| Assisted Turn | Automatic sailing/turning (TCS category B) |

[c] Turning mode

Displays a turning mode of automatic sailing.

| Display | Status |
|------------|----------------------------|
| No display | Automatic sailing inactive |
| MAN | Manual course change mode |
| AUTO | Automatic turning mode |

(5) Switching tab

When this tab is clicked on, the contents of the following dialog are switched.

[Clicking on the [Autosail] tab]

The dialog is switched to [Autosail] (automatic ailing) dialog.

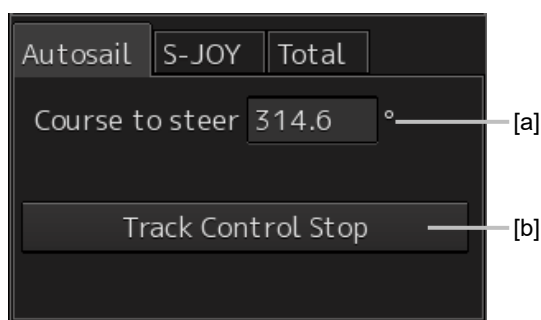

(a) Course to steer

Displays the course to steer to be transmitted to auto pilot.

(b) [Track Control Stop] (stop automatic sailing) button

To stop automatic sailing, click on this button.

The following message dialog is displayed.

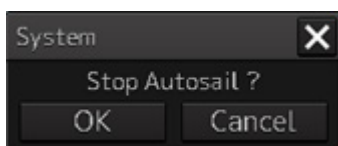

When the [OK] button is clicked on, automatic sailing terminates.

Memo

When a message dialog box indicating the switching of the Auto Pilot mode to the Manual mode is displayed, switch the Auto Pilot steering mode to the Manual mode.

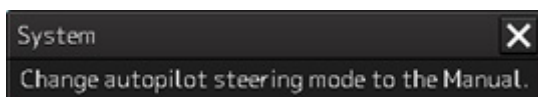

[Clicking on the [S-JOY] tab]

The dialog is switched to [S-JOY] dialog and information on S-JOY is displayed.

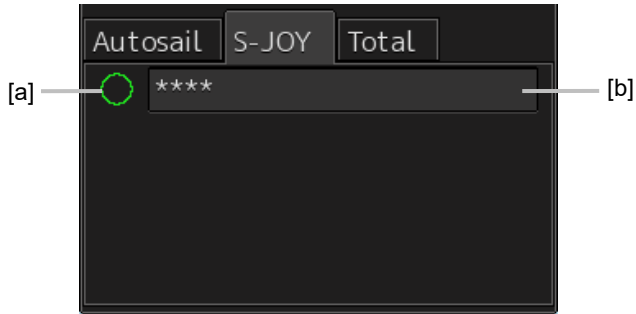

(a) Steering right

Displays the steering right of S-JOY.

When the steering right is available, the circle is filled.

(b) Mode

Displays the S-JOY mode.

The contents that are displayed in the dialog vary as follows.

| S-JOY mode | Contents that are displayed in the dialog |
|--------------|---|
| Track | - |
| Heading | Set HDG, Rudder Limit, ROT |
| Radius | Set HDG, Set Radius, ACT Radius, ROT |
| Planned Turn | Set HDG, Set Radius, ACT Radius, ROT |
| Rudder | Set Rudder, ACT Rudder, ROT |

[Clicking on the [Total] tab]

The dialog is switched to the [Total] dialog.

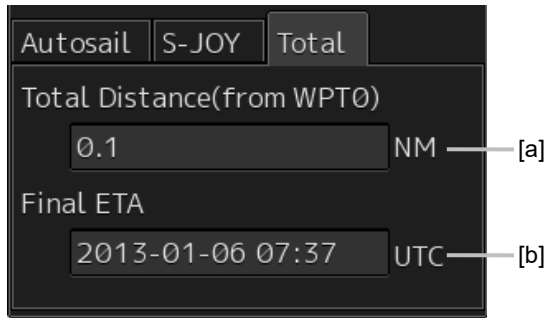

(a) [Total Distance (from WPT0)]

Displays the total distance from WPT0 to own ship.

(b) [Final ETA]

Displays the expected time of arrival to the final WPT that is calculated based on the current ship's speed.

8.4 [Voyage Calculation] Dialog Box

The [Voyage calculation] dialog box is used to calculate the expected WPT arrival time, the time required, and required ship speed

It is also possible to calculate a distance between two points such as between WPTs, from the own ship's position to WPT, or any position on the route to WPT.

Use the following procedure to open the [Voyage calculation] dialog box.

- 1 Click on the [Menu] button on the left toolbar.**
The menu is displayed.
- 2 Click on the [Route Monitoring] button on the menu.**
The [Route Monitoring] dialog box appears.
- 3 Click on the [Voyage calculation] button.**
The [Voyage calculation] dialog box appears.

When the [Schedule] (schedule calculation) button is clicked on, a schedule calculation dialog is displayed.

When the [Distance] (distance calculation) button is clicked on, a distance calculation dialog is displayed.

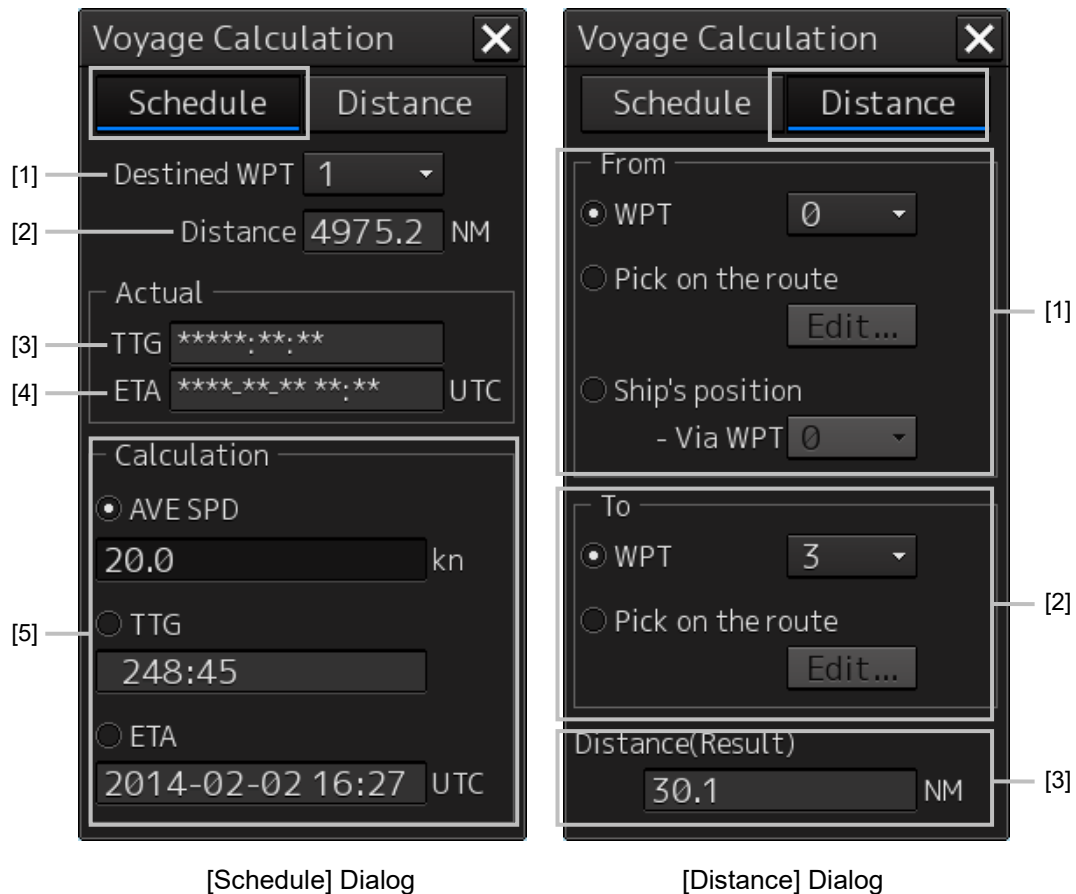

[Schedule] Dialog

[1] [Destined WPT] combo box

Select a destined WPT.

[2] [Distance] (Distance up to the destined WPT)

Displays a distance from the own ship's position to the selected WPT.

[3] [TTG] (Expected traveling time)

Displays a traveling time required based on the position from the current SOG value to the destined WPT.

[4] [ETA] (Expeded time of arrival)

Displays a time at arrival of the destined WPT from the current SOG value.

[5] [Calculation] (Calculation)

Selects a calculation method and enters the values.

[Distance] Dialog

[1] [From]

Selects a starting point calculation method and enters the values.

[2] [To]

Selects an ending point calculation method and enters the values.

[3] [Distance (Result)] (Distance calculation result)

Displays distance from the starting point and ending point that were obtained from the setting.

8.4.1 Calculating a schedule

The screenshot shows a dialog box titled "Voyage Calculation" with a close button (X) in the top right corner. The dialog has two tabs: "Schedule" (selected) and "Distance". Under the "Schedule" tab, there is a "Destined WPT" dropdown menu set to "1". Below it, the "Distance" is displayed as "4239.6 NM". There are two sections: "Actual" and "Calculation". The "Actual" section shows "TTG" as "2119:47:37" and "ETA" as "2014-05-02 20:51 UTC". The "Calculation" section has three radio button options: "Average Speed" (selected), "TTG", and "ETA". Under "Average Speed", the value "20.0" is entered in a text box followed by "kn". Under "TTG", the value "211:58" is entered in a text box. Under "ETA", the value "2014-02-12 09:02" is entered in a text box followed by "UTC".

- 1** Click on the [Schedule] button.
- 2** Click on the [Destined WPT] combo box.
- 3** Click on the WPT number whose schedule is to be calculated.

The measured distance from the own ship to the selected WPT, the estimated required time calculated based on the SOG (Speed Over the Ground), and the estimated time of arrival are displayed.

4 Select a calculation method and enter a value.

When [Average Speed] (calculated ship's speed), [TTG] (calculated traveling time), or [ETA] (calculated time of arrival) is selected and a value is entered, the calculation result of the ship's speed, expected traveling time, and expected time of arrival are displayed. These three items are displayed by linking.

[Average Speed]: Enter a ship's speed.

[TTG]: Enter a calculated traveling time.

[ETA]: Enter a calculated time of arrival by using a calendar/time picker.

8.4.2 Calculating a distance

The screenshot shows a dialog box titled "Voyage Calculation" with a close button (X) in the top right corner. The dialog has two tabs: "Schedule" and "Distance", with "Distance" being the active tab. The "From" section contains three radio buttons: "WPT" (selected), "Pick on the route", and "Ship's position". The "WPT" option has a dropdown menu showing "1". Below "Pick on the route" is an "Edit..." button. The "Ship's position" option has a sub-label "- Via WPT" and a dropdown menu showing "0". The "To" section also contains three radio buttons: "WPT" (selected), "Pick on the route", and "Ship's position". The "WPT" option has a dropdown menu showing "2". Below "Pick on the route" is another "Edit..." button. At the bottom of the dialog, there is a text field labeled "Distance(Result)" containing the value "2.8" and the unit "NM".

1 Click on the [Distance] button.

2 Select starting point calculation method and enter a value.

Set a starting point for distance calculation by selecting [WPT] (selection of starting WPT), [Pick on the route] (selecting any position on the starting route), or [Ship's position] (selection of the own ship's position).

[WPT]: Click on a WPT used as the starting point from the combo box.

[Pick on the route]: Any position on the routes set in the starting WPT and the end WPT is used as the starting point.

When the [Edit] (editing any position) button is clicked, the color of the selectable route changes to green. When any position is clicked, that position becomes the starting point.

[Ship's position]: The own ship's position is used as the starting point. Click on the WPT to be passed through from the [Via WPT] combo box.

3 Select an ending point calculation method and enter a value.

Set an ending point for distance calculation by selecting [WPT] (selection of ending WPT) or [Pick on the route] (selecting any position on the ending route).

[WPT]: Click on a WPT used as the ending point from the combo box.

[Pick on the route]: Any position on the routes set in the starting WPT and the end WPT is used as the end point.

When the [Edit] (editing any position) button is clicked, the color of the selectable route changes to green. When any position is clicked, that position becomes the end point.

Memo

When the [Edit] button is clicked on, the following message dialog box appears.

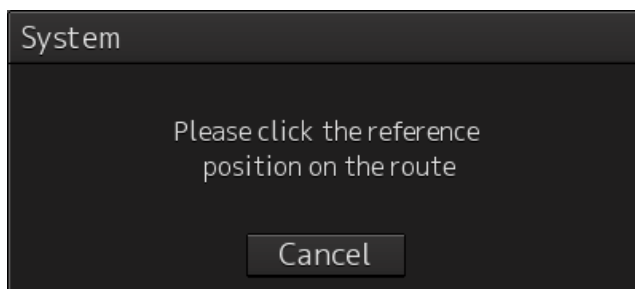

Position selection can be cancelled by clicking on the [Cancel] button.

8.4.3 Example of distance calculation

Calculating with [WPT]

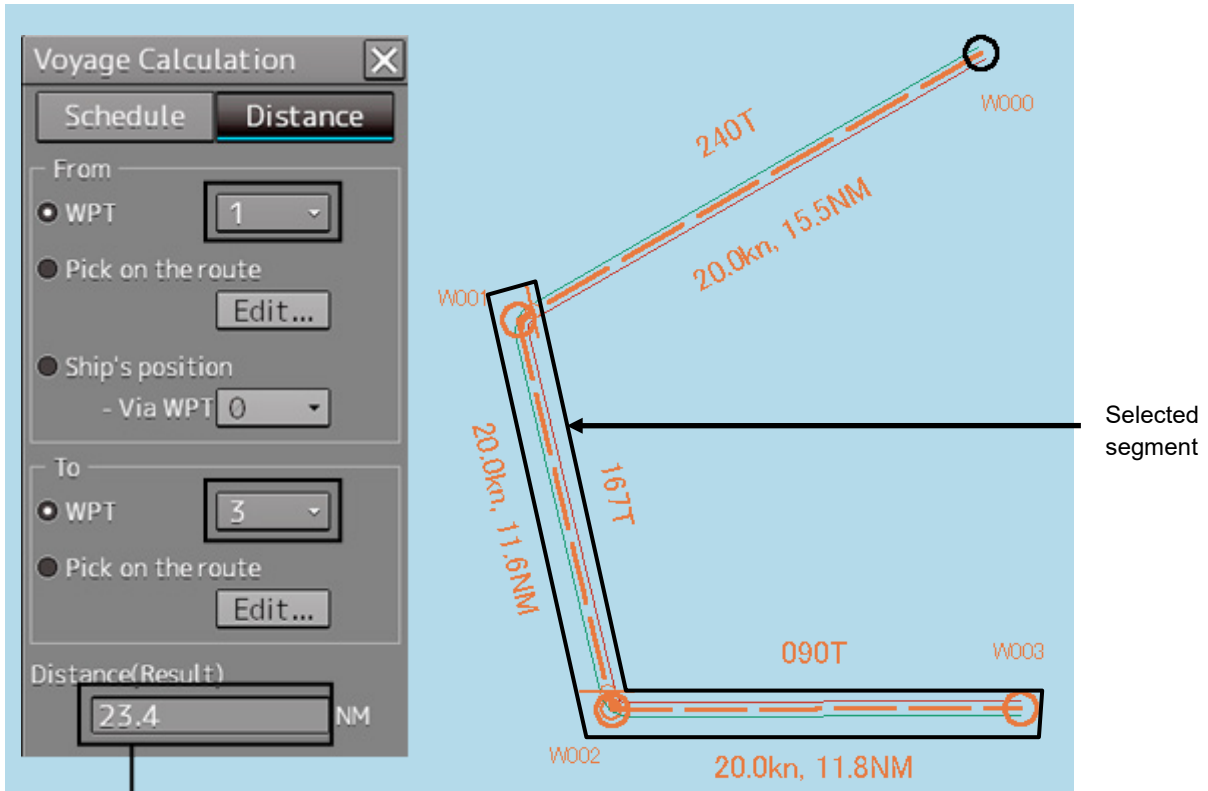

Route distance between selected WPTs

Selecting [Pick on the route] (Selecting any starting point on the route) as the starting point:

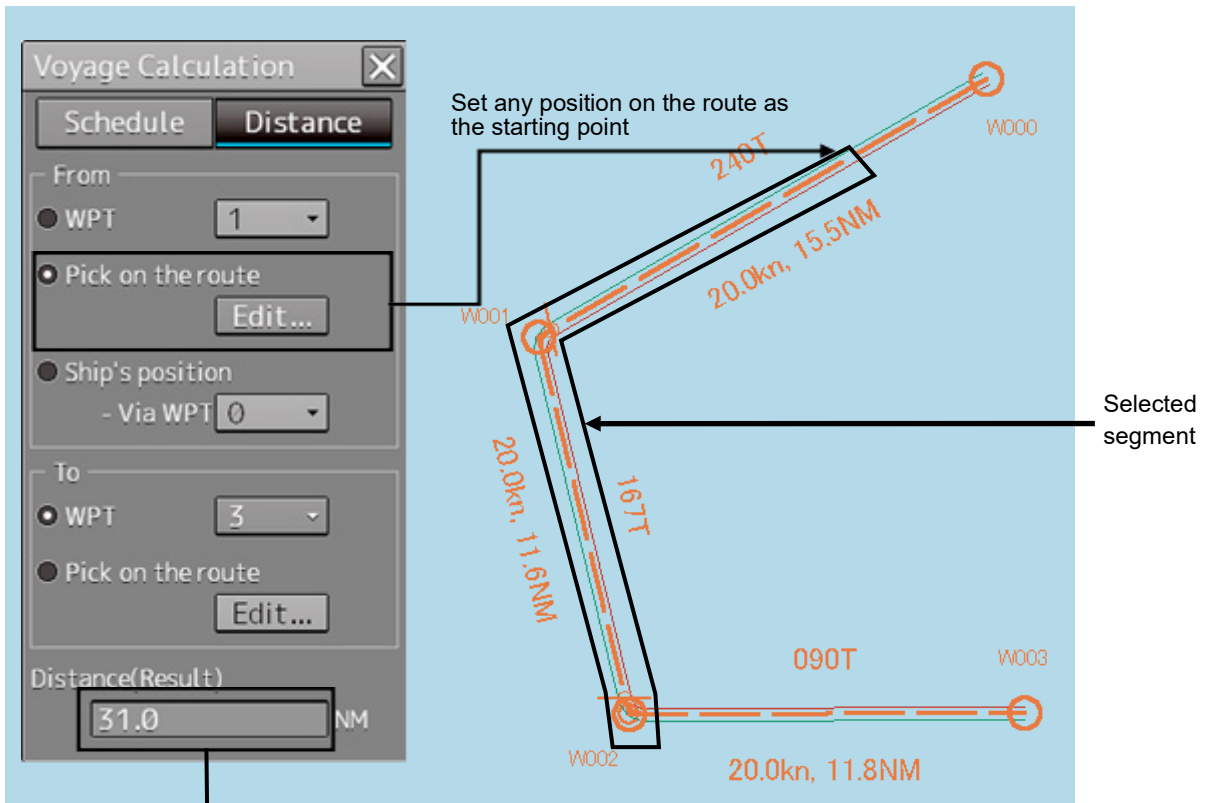

Route distance between selected WPTs

Selecting [Ship's position] (Selecting the own ship's starting position):

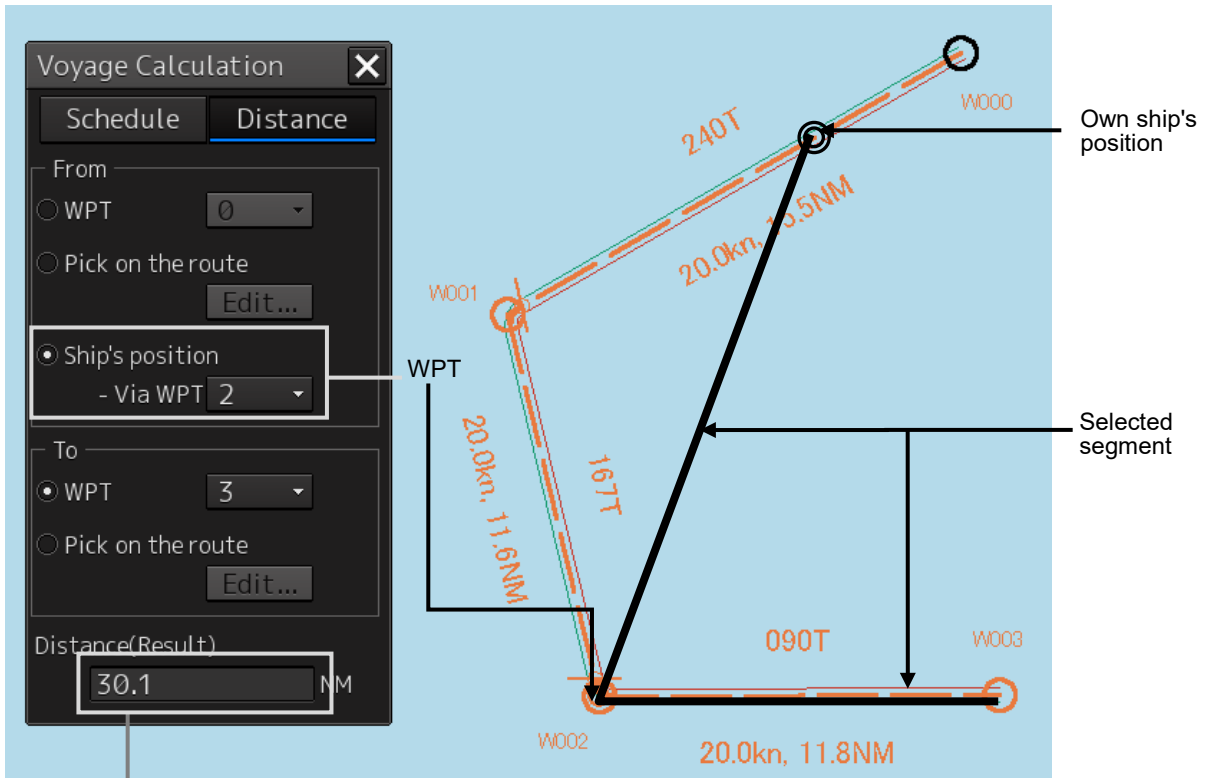

8.5 Comparing the Data between the Planned Route and the Actual Route

The [Pair of data] dialog box enables comparison of data between the planned route and the actual route.

Use the following procedure as below to open the [Pair of data] dialog box.

- 1 Click on the [Menu] button on the left toolbar.**

The menu is displayed.

- 2 Click on the [Route Monitoring] button on the menu.**

The [Route Monitoring] dialog box appears.

- 3 Click on the [Pair of data] button.**

The [Pair of data] dialog box appears.

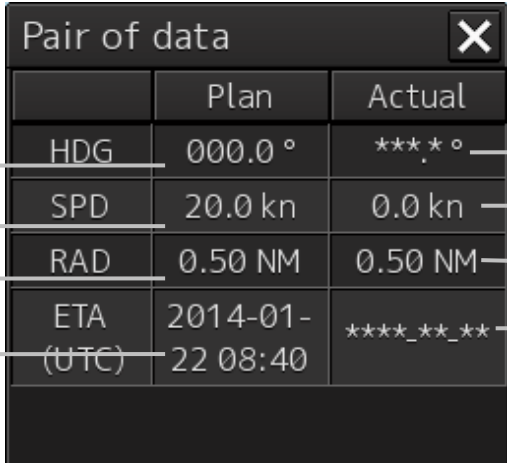

The screenshot shows a dialog box titled "Pair of data" with a close button (X) in the top right corner. The dialog box contains a table with two columns: "Plan" and "Actual". The rows are labeled with callouts [1] through [8].

| | Plan | Actual |
|------------------|----------------------|------------------|
| [1] HDG | 000.0 ° | ***.* ° [5] |
| [2] SPD | 20.0 kn | 0.0 kn [6] |
| [3] RAD | 0.50 NM | 0.50 NM [7] |
| [4] ETA (UTC) | 2014-01- 22 08:40 | ****_*_*_*_* [8] |

Planned data is displayed in [Plan] (route plan) and the actual route data is displayed in [Actual] (actual route) in the dialog.

[1] Planned course

Displays a planned course.

[2] Planned ship's speed

Displays a planned ship's speed.

[3] Planned turn radius

Displays a planned turn radius.

[4] Planned ETA

Displays a planned expected time of arrival.

[5] Actual ship's heading

Displays an actual ship's heading.

[6] Actual speed

Displays an actual ship's speed.

[7] Actual turn radius

Displays an actual turn radius.

[8] Actual ETA

Displays an expected time of arrival (ETA) that is calculated from the actual ship's speed.

8.6 Verifying Detail Information of WPT

Detail information of each WPT on the route can be verified.

Use the following procedure to display the detail information of WPT.

1 Right-click on [WPT].

The context menu is displayed.

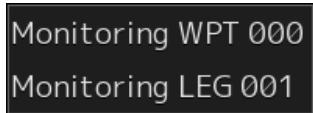

2 Click on the WPT to be verified from the context menu.

The context menu is displayed.

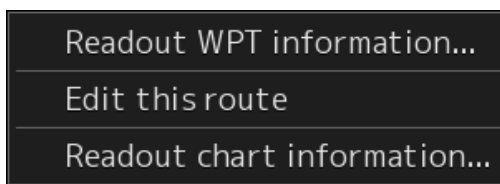

3 Click on [Readout WPT information...].

The detail information dialog of the WPT is displayed.

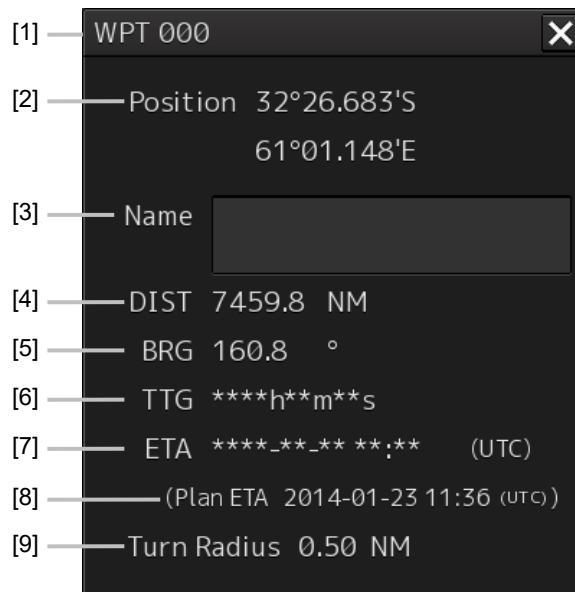

[1] WPT number

Displays a WPT number.

[2] [Position] (WPT position)

Displays the latitude/longitude of WPT.

[3] [Name] (WPT name)

Displays a WPT name.

[4] [DIST] (Distance between own ship and WPT)

Displays a distance from the own ship's position to WPT.

[5] [BRG] (Bearing between own ship and WPT)

Displays a bearing from the own ship to WPT.

[6] [TTG] (Expected time required to reach WTP)

Displays a time required to reach WPT based on the own ship's speed (SOG) and the distance.

[7] [ETA] (Expected time of arrival at WPT)

Displays an expected time of arrival at WPT based on the own ship's speed (SOG) and the distance.

[8] [Plan ETA] (Expected time of arrival at WPT)

Displays an expected time of arrival based on route planning.

[9] [Turn Radius] (Turn radius)

Displays a WPT turn radius.

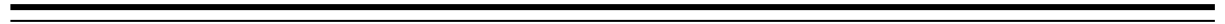

Section 9 Monitoring a Dragging Anchor

Anchor Watch is a function that sets a circular or polygonal dragging anchor monitoring area around the own ship and realizes safe voyage by generating an anchor alarm when a part of the outline of the own ship exceeded the monitoring area.

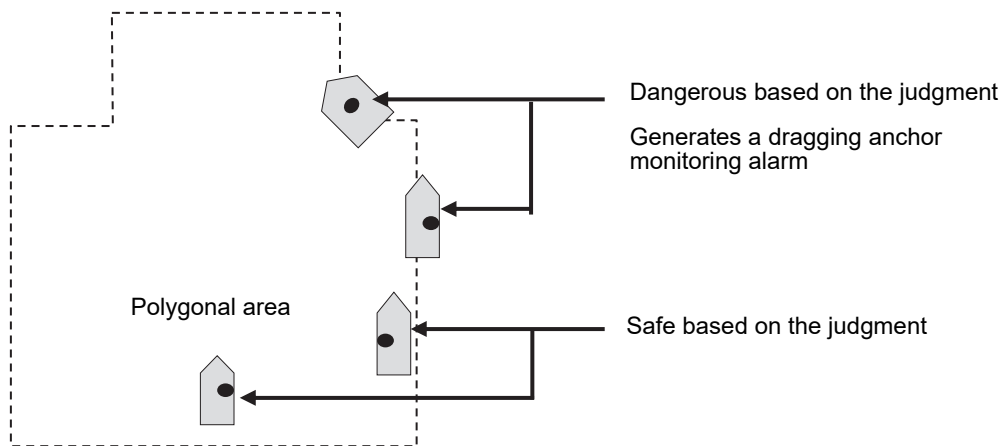
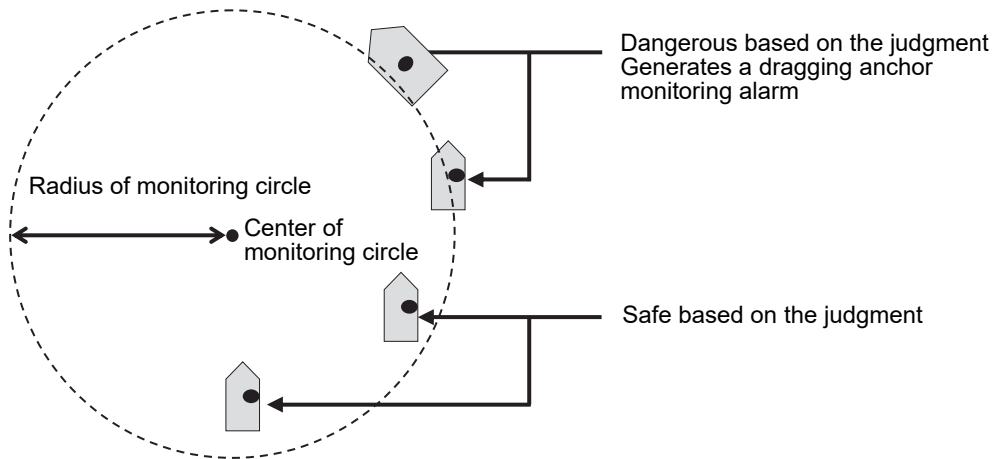

Dragging Anchor Monitoring Area

9.1 Setting a Dragging Anchor Monitoring Area

This section describes the setting of a dragging anchor monitoring area.

The setting varies depending on whether the shape of the dragging anchor area is a circle or a polygon.

9.1.1 Setting a dragging anchor monitoring circle

- 1** Click on the [Menu] button on the left toolbar.
The menu is displayed.
- 2** Click on the [Anchor Watch] button on the menu.
The [Anchor Watch] dialog box appears.
- 3** Select [Circle] from the [Mode] (dragging anchor monitoring mode selection) combo box.

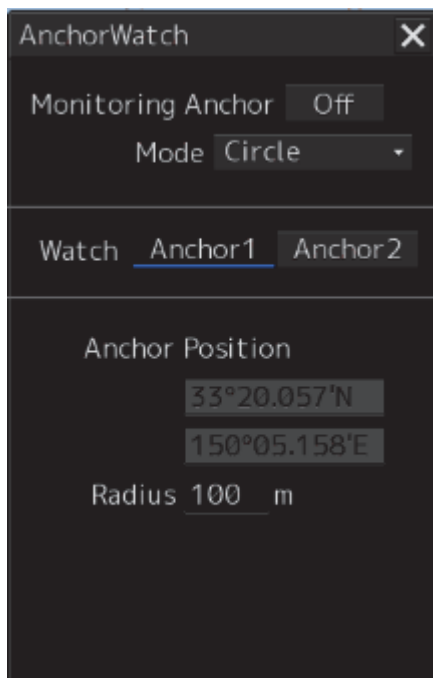

4 Select the initial position of the center position of the dragging anchor monitoring circle from the [Watch] button.

Change the initial position of the center position of the dragging anchor monitoring circle to the anchor position.

The anchor position can be selected from those set in the equipment setting.

Coordinates are displayed at **[Anchor Position] (center of the dragging anchor monitoring circle)**.

**5 Enter the size of the dragging anchor monitoring area.
[Radius] (Radius of the dragging anchor monitoring circle)**

Input range

10 to 1500 m

9.1.2 Setting a dragging anchor monitoring polygon

- 1 Click on the [Menu] button on the left toolbar.**
The menu is displayed.
- 2 Click on the [Anchor Watch] button on the menu.**
The [Anchor Watch] dialog box appears.
- 3 Select [Polygon] from the [Mode] (dragging anchor monitoring mode selection) combo box.**

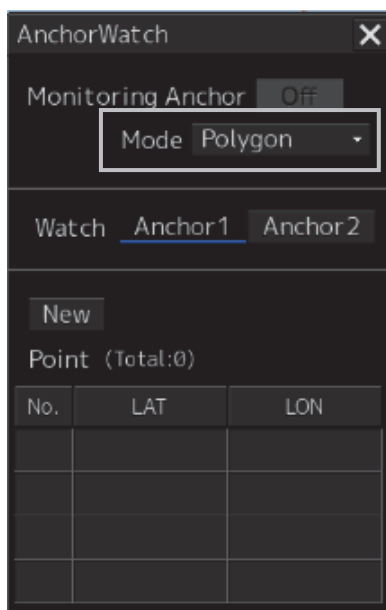

- 4 Click on the [New] button.**
The data of the [Point] (vertex) list is cleared.
- 5 Place the cursor on the chart.**
- 6 Click to determine the vertex position. Create three or more vertices to create a polygon.**
By inputting position coordinates (longitude and latitude) of the vertex positions of the polygon in the [Point] list, the vertex position can be changed.
When the polygon is created, the number of vertices is displayed in [(Total:)]. Up to 360 vertices can be set.

Creation example:

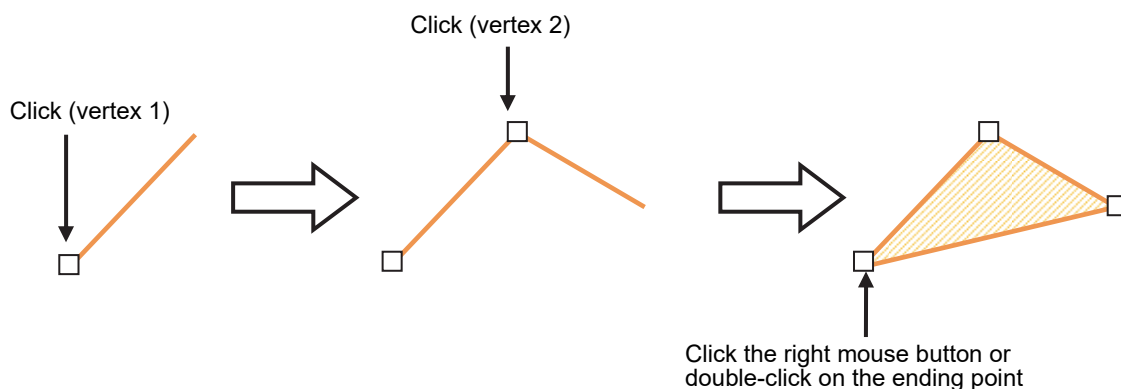

9.2 Starting and Ending Dragging Anchor Monitoring

9.2.1 Starting dragging anchor monitoring

- 1 Click on the [Menu] button on the left toolbar.
The menu is displayed.
- 2 Click on the [Anchor Watch] button on the menu.
The [Anchor Watch] dialog box appears.

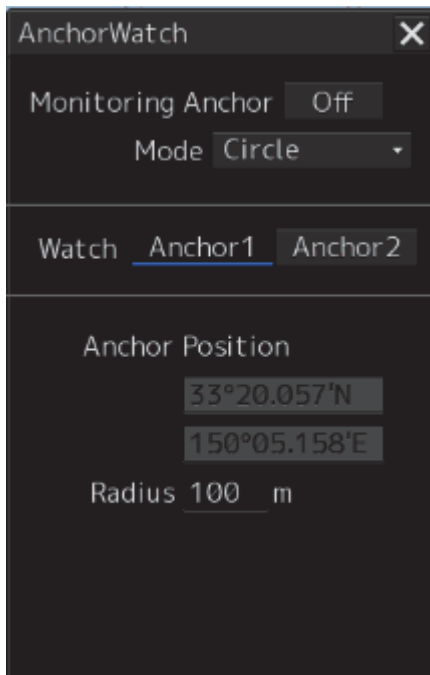

The preview of dragging anchor monitoring area that was set is displayed (broken line).

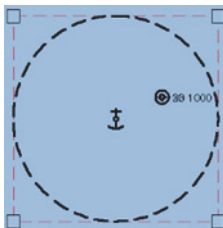

When the dialog is displayed, the anchor position is placed at the center of the circle.

- 3 Set dragging anchor monitoring to ON by clicking on the [Monitoring Anchor] button.

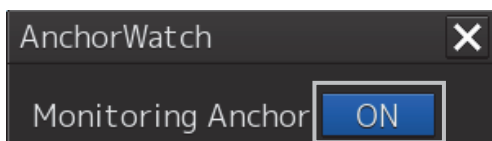

Dragging anchor monitoring starts based on the setting.

The dragging anchor monitoring area on the chart is changed to a solid line.

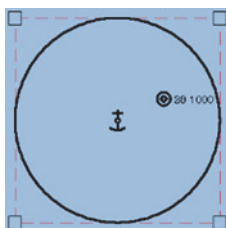

When own ship exits from the dragging anchor monitoring area, the "Outside Anchor Watch Area" warning is displayed.

Memo

"Outside Anchor Watch Area" warning escalates to "Outside Anchor Watch Area" alarm 2 minutes after own ship exits from the dragging anchor monitoring area.

9.2.2 Ending dragging anchor monitoring

Set the button display to [OFF] by clicking on the [Monitoring Anchor] button.

Alternatively, use the following procedure.

- 1 **Click the dragging anchor monitoring circle.**

A context menu is displayed.

- 2 **Click [Finish Monitoring Anchor] on the context menu.**

The [Monitoring Anchor] button display is changed to [OFF] and the display of the dragging anchor monitoring area on the chart is changed to the broken line display.

9.3 Moving/Editing/Deleting a Dragging Anchor Monitoring Area on the Chart

The size and shape of the anchor monitoring area can be changed or deleted on the chart. These operations are also available on the context menu.

These operations can be performed either before or after starting dragging anchor monitoring.

9.3.1 Changing a size of a dragging anchor monitoring circle on the chart

9

- 1 Click on the dragging anchor monitoring circle.

A square enclosing the dragging anchor monitoring circle is displayed.

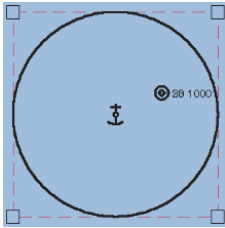

- 2 Click on any of the vertices of the square enclosing the dragging anchor monitoring circle.

The cursor changes to the arrow cursor.

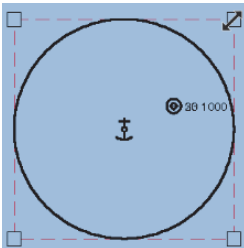

- 3 Move the cursor until the dragging anchor monitoring circle becomes a required size and click the mouse button.

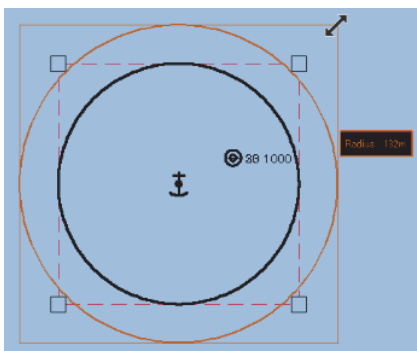

The size of the dragging anchor monitoring circle is changed.

9.3.2 Changing a size of a dragging anchor monitoring circle on the context menu

Change of a dragging anchor monitoring circle can also be executed from the context menu.

- 1 Click on the dragging anchor monitoring circle.**
A square enclosing the dragging anchor monitoring circle is displayed.
- 2 Click on any of the vertexes of the square enclosing the dragging anchor monitoring circle.**
A context menu is displayed.
- 3 Click on [Change radius] on the context menu.**
The cursor is set to the Arrow cursor.
- 4 Move the cursor until the dragging anchor monitoring circle becomes a required size and click the mouse button.**
The size of the dragging anchor monitoring circle is changed.

9.3.3 Changing a shape of a dragging anchor monitoring polygon on the chart

Changing a vertex

- 1 Click on the vertex of the dragging anchor monitoring polygon to be changed.**
The cursor is set to the Edit cursor.

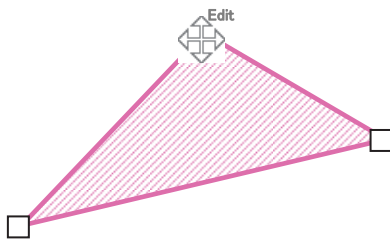

- 2 Move the cursor to the required vertex position of the dragging anchor monitoring polygon and click the mouse button.**

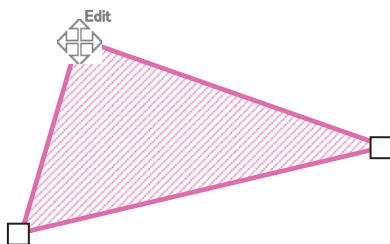

The position of the vertex is changed.

Adding a vertex

- 1 Click the mouse button on the position where a vertex to be added.

The cursor is set to the Edit cursor.

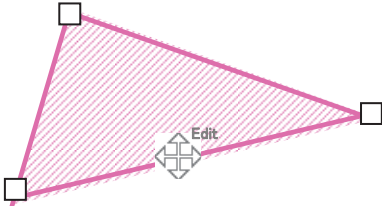

- 2 Move the cursor to the position where a vertex is to be set and click the mouse button.

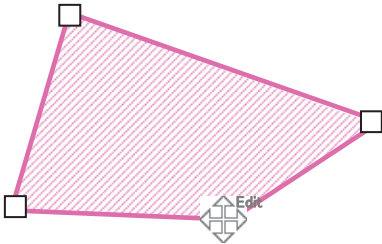

A new vertex is added.

9.3.4 Changing a shape of a dragging anchor monitoring polygon on the context menu

The following operation can be performed on the context menu that is displayed by clicking the right mouse button on the dragging anchor monitoring polygon.

[Clicking the right mouse button on the line other than vertices of the dragging anchor monitoring polygon]

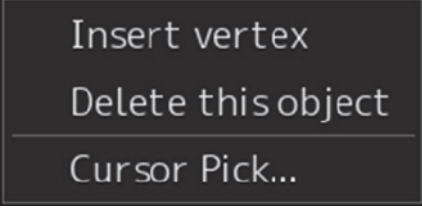

[Clicking the right mouse button on a vertex of a dragging anchor monitoring polygon]

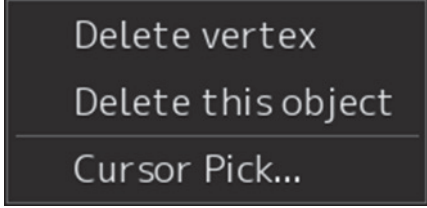

Each function is as follows.

- [Insert vertex] (Addition of a vertex)
Adds a vertex at the position where the mouse button is clicked on.
- [Delete vetex] (Deletion of a vertex)
Deletes the selected vertex.
- [Delete this object] (Deletion of an object)
Deletes a selected dragging anchor monitoring polygon.

Note

When deletion of a dragging anchor monitoring polygon is attempted during execution of dragging anchor monitoring, the following message dialog box is displayed.

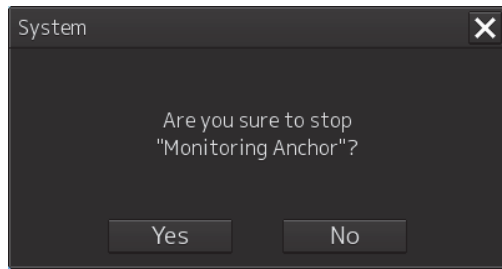

To execute deletion, click on the [Yes] button. The monitoring area is deleted and dragging anchor monitoring is terminated.

Section 10 Automatic Sailing (Option)

Note

In case of JAN-7201S/9201S, automatic sailing function is not available by function restriction.



WARNING



When automatic sailing is performed, the operator must confirm the safety of the route and the safety at crossing of a safety contour line. Otherwise, an accident may occur.

10

When Auto Pilot is connected to this equipment, it is possible to calculate the course to steer from the planned route and the own ship's position and guide the ship automatically according to the planned route by outputting the course to steer to Auto Pilot.

Note

- The ECDIS screen cannot be terminated during automatic sailing.
- When MAG (Magnetic Compass) is selected as the sensor source of Heading (ship's heading), automatic sailing cannot be started.

Memo

For the details of the principle and setting of automatic sailing, refer to "16.9 Setting up Parameter Values for Automatic Sailing".

For the details of the Auto Pilot operation, refer to the Auto Pilot Instruction Manual.

10.1 Flow of Starting Automatic Sailing

Note

In case of JAN-7201S/9201S, automatic sailing function is not available by function restriction. Therefore the operation is not available.

- 1 Click on the [Menu] button on the left toolbar.
The menu is displayed.

- 2 Click on the [Auto Sail] - [Start] on the menu.
The automatic sailing starting wizard ([Auto Sail] dialog box) appears.

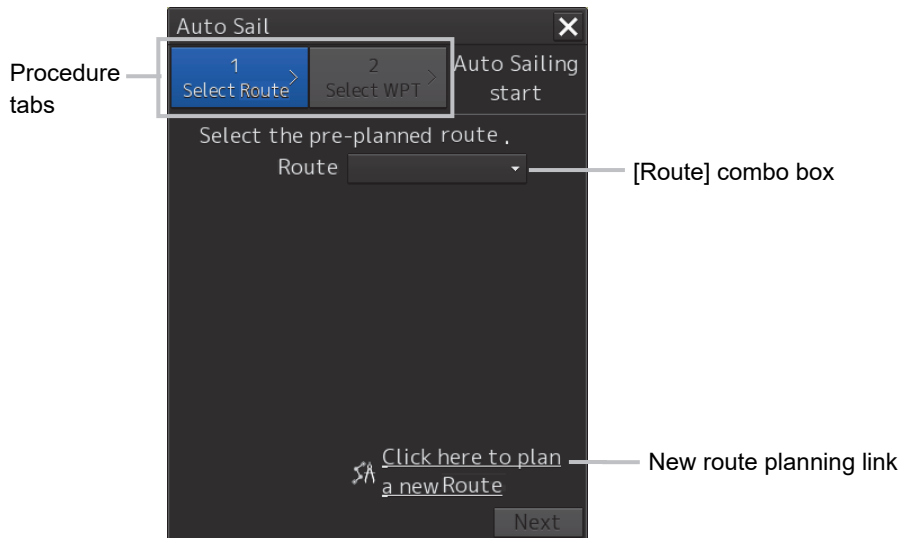

- 3 Click a planned route file to be used from the [Route] combo box of Procedure tab 1.

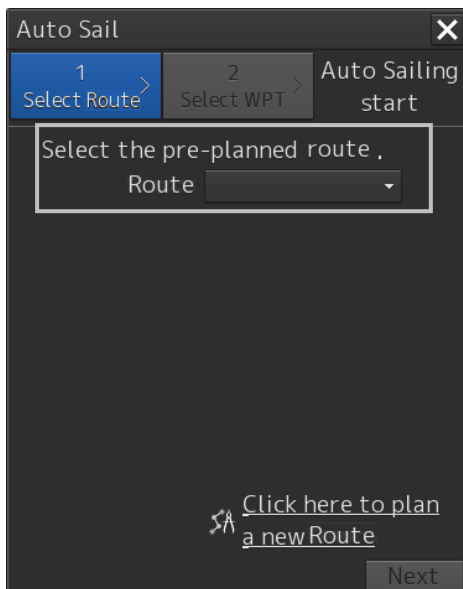

- 4 After checking a track, click on the [Next] button.

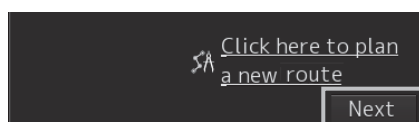

The dialog of Procedure tab 2 is displayed.

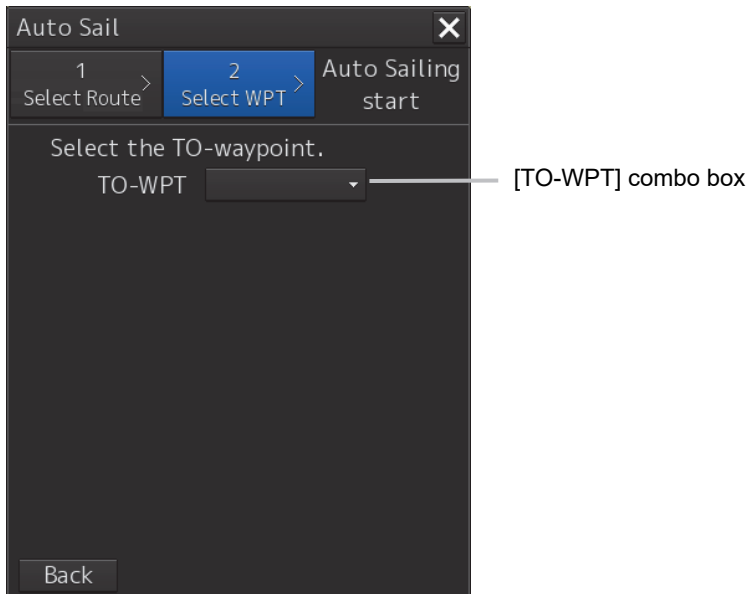

10

- 5 Click on the waypoint from which Autosail is to start from the [TO-WPT] (waypoint) combo box.

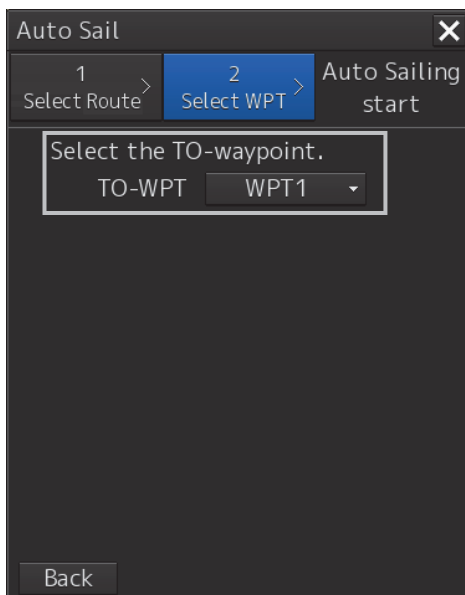

6 Start automatic sailing by clicking on the [Start] button.

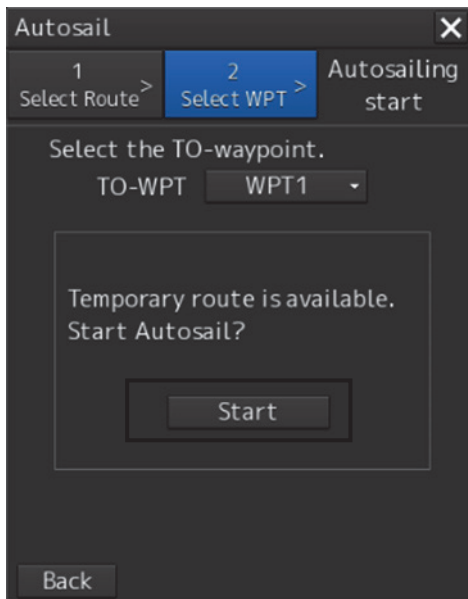

During route monitoring

During route monitoring, the name of the planned route that is currently used is displayed in the [Route] combo box.

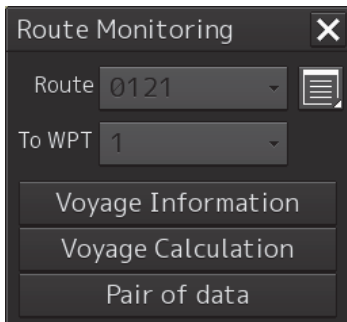

To use another planned route for automatic sailing, re-select a planned route.

Occurrence of an error

The following message dialog box appears.

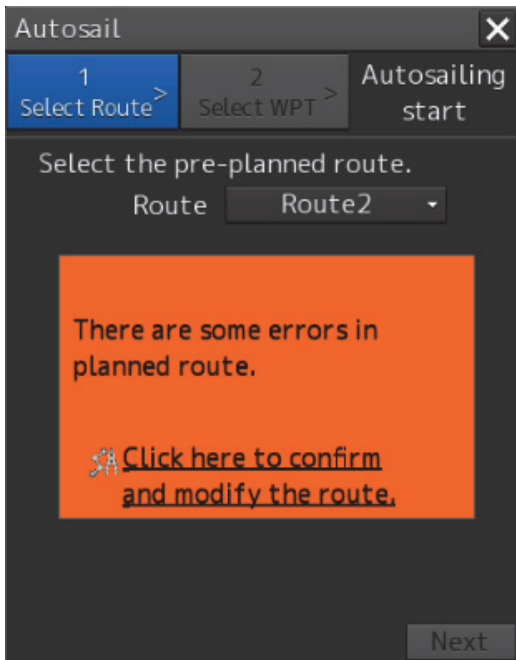

When the above error occurs, automatic sailing cannot be started.

Cancel the alert by closing the dialog box by clicking on the [X] (Close) button.

For the details of the alerts that are displayed during automatic sailing, refer to "10.6 Alerts at Automatic Sailing".

Creating a new route

- 1 Click on the [Click here to plan a new route] link.**
The [Route Planning] dialog box appears.
For the details, refer to "10.2.2 Creating a new route".

10.2 Selecting a Route

Note

In case of JAN-7201S/9201S, automatic sailing function is not available by function restriction. Therefore the setup is not available.

10.2.1 Using the existing planned route

- 1 To use the existing planned track for automatic sailing, select the planned route file to be used from the [Route] combo box.

Checking of the selected route starts.

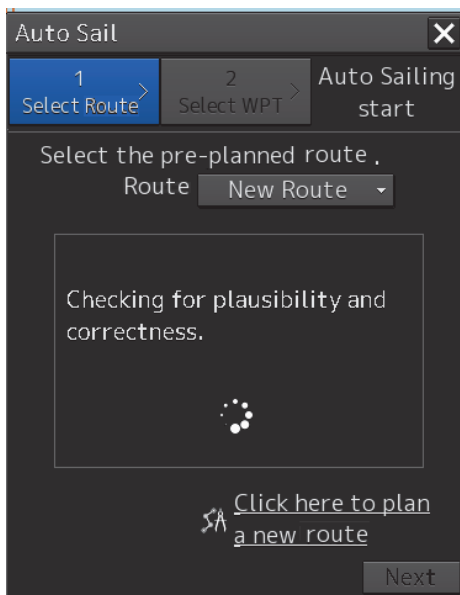

If there is no problem in the route, a route safety confirmation message is displayed and the [Next] button is enabled.

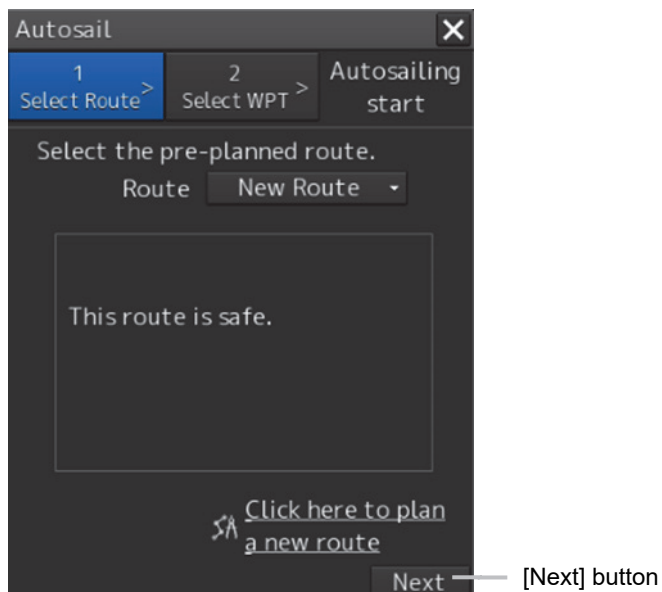

Detecting an error

When an error is detected as a result of checking the route, an error message is displayed.

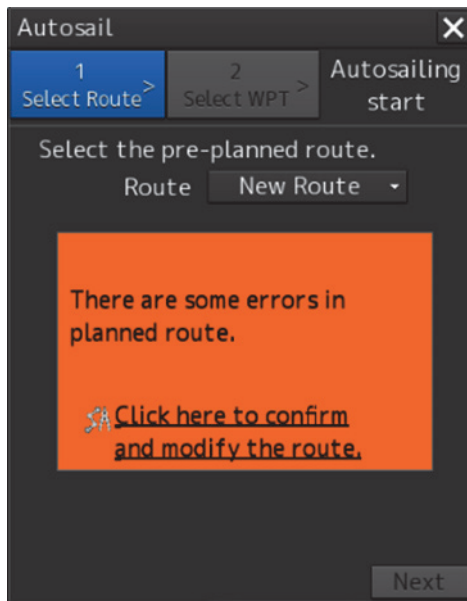

10

Change the route file or modify the selected route.

Use the following procedure for modifying a route.

- 1 Click on the [Click here to confirm and modify the route] (confirmation and modification of route) link.

The [Route Planning] dialog box is opened.

The screenshot shows the 'Route Planning' dialog box. It has a menu bar with 'New', 'Open...', 'Save', 'Edit', and 'Show Route Check...'. Below the menu bar, there is a 'New Route' dropdown and an 'Insert Delete' button. The main area contains a table with the following columns: WPT No., Name, Position (LAT, LON), Leg (BWW, Distance), Sail, XTD (PORT, STBD), Arrival Radius, Turning Radius, Planned Speed, ROT, ETA (YYYY-MM-DD hh:mm), Time Zone, and TWOL (Days hh:mm). The table has 5 rows, with row 2 highlighted in orange.

| WPT No. | Name | Position | | Leg | | Sail | XTD | | Arrival Radius | Turning Radius | Planned Speed | ROT | ETA [YYYY-MM-DD hh:mm] | Time Zone | TWOL [Days hh:mm] |
|---------|------|-------------|-------------|--------|----------|------|--------|--------|----------------|----------------|---------------|-----------|------------------------|-----------|-------------------|
| | | LAT | LOE | BWW | Distance | | PORT | STBD | | | | | | | |
| 0 | | 32°22.104'S | 60°40.813'E | | | | | | | | | | 2017-06-17 04:05 | 00:00 | |
| 1 | | 32°22.305'S | 60°45.965'E | 092.6° | 4.4NM | RL | 0.20NM | 0.20NM | 0.50NM | 0.50NM | 20.0kn | 38.2°/min | 2017-06-17 04:18 | 00:00 | 00 Days 00:13 |
| 2 | | 32°22.999'S | 61°22.168'E | 091.3° | 30.7NM | RL | 0.20NM | 0.20NM | 0.50NM | 0.50NM | 20.0kn | 38.2°/min | 2017-06-17 05:50 | 00:00 | 00 Days 01:32 |
| 3 | | 32°24.035'S | 61°30.765'E | 098.1° | 7.4NM | RL | 0.20NM | 0.20NM | 0.50NM | 0.50NM | 20.0kn | 38.2°/min | 2017-06-17 06:13 | 00:00 | 00 Days 00:22 |
| 4 | | 32°25.870'S | 61°38.215'E | 088.5° | 6.3NM | RL | 0.20NM | 0.20NM | 0.50NM | 0.50NM | 20.0kn | 38.2°/min | 2017-06-17 06:32 | 00:00 | 00 Days 00:18 |

When an error occurred in the planned route, a badge indicating the number of errors is displayed on the [Show Route Check...] (route checking screen display) button.

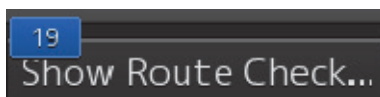

2 Click on the [Show Route Check...] button.

The [Check Route] dialog box that displays the result of the route checking appears.

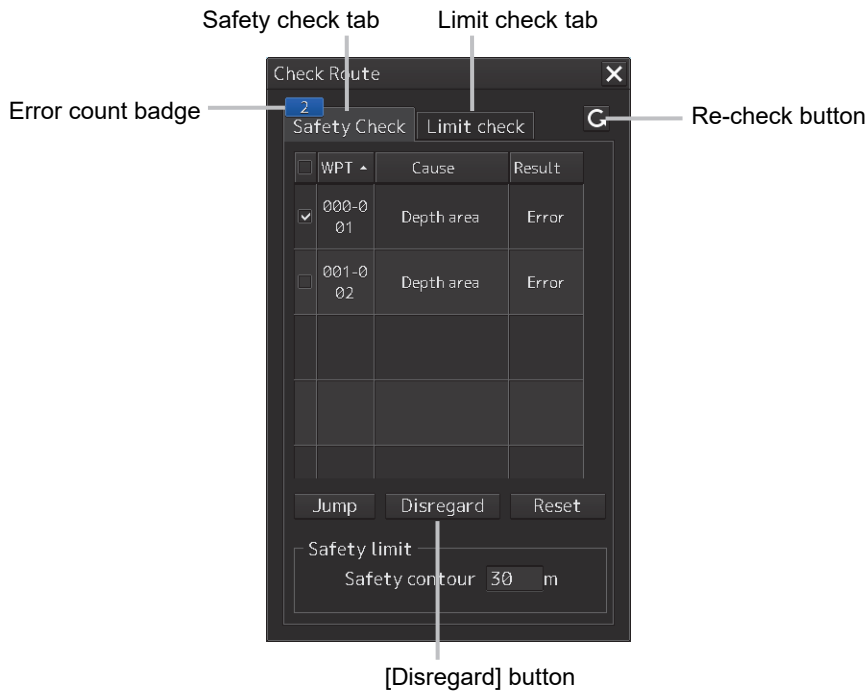

3 Modify the route, save the file by overwriting, and close the [Route Planning] dialog box.

The route safety confirmation message is displayed.

For the details of the route planning operation, refer to "Section 7 Route Planning"

10.2.2 Creating a new route

A new planned route to be used for automatic sailing can be created.

1 Click on the [Click here to plan a new route] link.

The [Route Planning] dialog box is opened.

2 Create and save a new planned route and close the [Route Planning] dialog box.

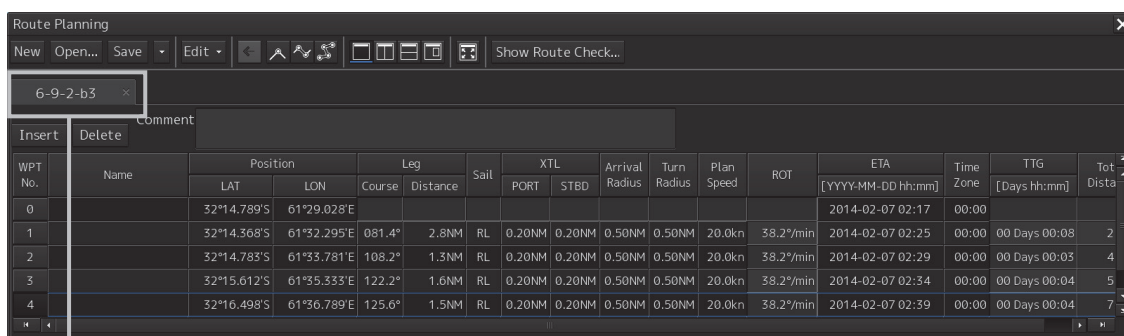

The screenshot shows the 'Route Planning' dialog box with a table of route data. The table has columns for WPT No., Name, Position (LAT, LON), Leg (Course, Distance, Sail), XTL (PORT, STBD), Arrival Radius, Turn Radius, Plan Speed, ROT, ETA, Time Zone, TTG, and Tot. The data is as follows:

| WPT No. | Name | Position | | Leg | | | XTL | | Arrival Radius | Turn Radius | Plan Speed | ROT | ETA | Time Zone | TTG | Tot. Dist. |
|---------|------|-------------|-------------|--------|----------|------|--------|--------|----------------|-------------|------------|-----------|------------------|-----------|---------------|------------|
| | | LAT | LON | Course | Distance | Sail | PORT | STBD | | | | | | | | |
| 0 | | 32°14.789'S | 61°29.028'E | | | | | | | | | | 2014-02-07 02:17 | 00:00 | | |
| 1 | | 32°14.368'S | 61°32.295'E | 081.4° | 2.8NM | RL | 0.20NM | 0.20NM | 0.50NM | 0.50NM | 20.0kn | 38.2°/min | 2014-02-07 02:25 | 00:00 | 00 Days 00:08 | 2 |
| 2 | | 32°14.783'S | 61°33.781'E | 108.2° | 1.3NM | RL | 0.20NM | 0.20NM | 0.50NM | 0.50NM | 20.0kn | 38.2°/min | 2014-02-07 02:29 | 00:00 | 00 Days 00:03 | 4 |
| 3 | | 32°15.612'S | 61°35.333'E | 122.2° | 1.6NM | RL | 0.20NM | 0.20NM | 0.50NM | 0.50NM | 20.0kn | 38.2°/min | 2014-02-07 02:34 | 00:00 | 00 Days 00:04 | 5 |
| 4 | | 32°16.498'S | 61°36.789'E | 125.6° | 1.5NM | RL | 0.20NM | 0.20NM | 0.50NM | 0.50NM | 20.0kn | 38.2°/min | 2014-02-07 02:39 | 00:00 | 00 Days 00:04 | 7 |

Route editing tab

For the details of "Route Planning", refer to "Section 7 Route Planning".

3 Use the newly created planned route by referring to "10.2.1 Using the existing planned route".

10

When the four route files have been opened

If four route files are already opened, no new edit tab can be opened unless the route edit tab that is already open is deleted once.

10.3 Selecting a Waypoint at which Automatic Sailing Starts

Note

In case of JAN-7201S/9201S, automatic sailing function is not available by function restriction. Therefore the setup is not available.

Select a WPT (waypoint) at which automatic sailing starts.

- 1 Click on Procedure tab 2.
When selecting Procedure tab 1, click on the [Next] button.

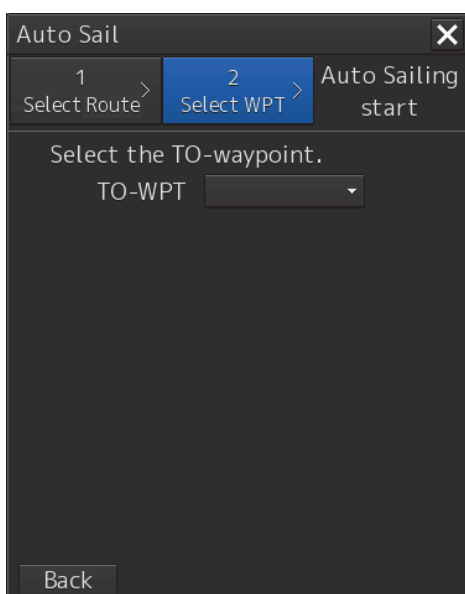

When the [Back] button is clicked on, control returns to the route selection screen, enabling re-selection of a route.

- 2 Click on the waypoint at which automatic sailing starts from the [TO-WPT] combo box.

Note

When the [Auto Sail] dialog box is activated during route monitoring, WPT that has been passed through cannot be selected.

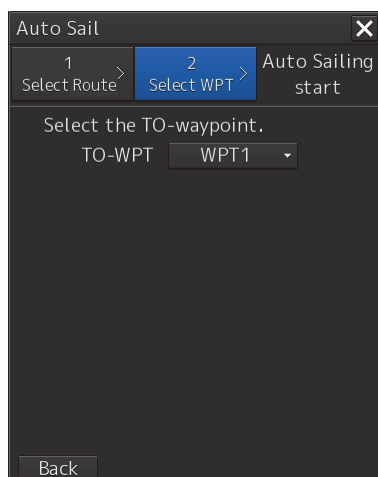

Creation of the temporary route to the selected WPT starts.

When the temporary route is created, a completion message and the [Start] button are displayed.

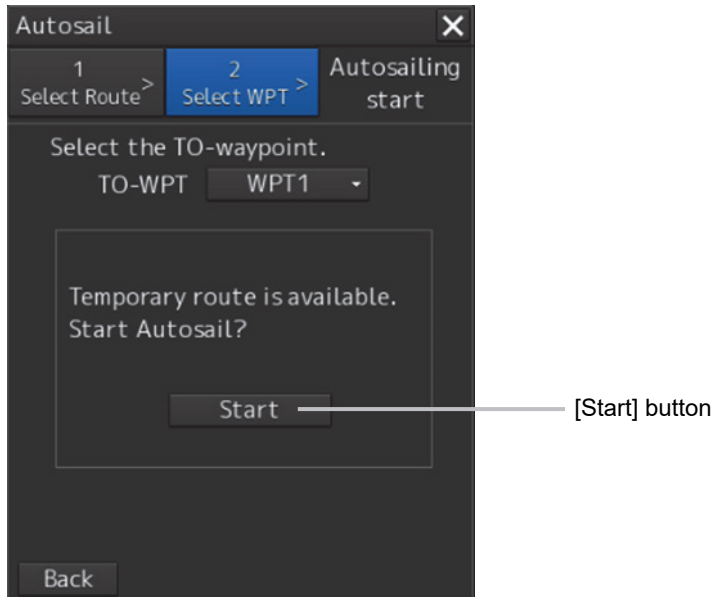

When a temporary route cannot be created, the following error message is displayed.

| Error message | Cause | Measures |
|--|--|--|
| Cannot create the temporary route because the course is inappropriate. Turn the course toward the planned course. | The temporary route could not be created due to the inappropriate course. | Approximate the ship's heading to the planned route. |
| Cannot create the temporary route because the XTD exceed XTD MAX. Move own ship toward the planned route. | Since XTD is too large, the temporary route could not be created. | Approximate own ship to the planned route. |
| Cannot create the temporary route because own ship may pass through the WOL. Select the TO-Waypoint again. | Since own ship may pass through the WOL, the temporary route could not be created. | Re-select TO-WPT. |
| Cannot create the temporary route because own ship may pass through the planned route leg. Select the TO-Waypoint again. | Since own ship may pass through the planned route, the temporary route could not be created. | Re-select TO-WPT. |

Memo
 Even if the predicted route creation starting condition processing fails, the predicted route is drawn.

10.4 Starting Automatic Sailing

Note

In case of JAN-7201S/9201S, automatic sailing function is not available by function restriction. Therefore the setup is not available.

WARNING



If your ship has reached a veering circle during the automatic navigation, make sure that the safety check and veering operation are made by the ship operator himself.

If veering operation is not made, regression bearing will be maintained without veering. This may cause an accident.



Input the ship's parameter accurately according to the specification of the ship.

Otherwise, accidents may result.

CAUTION



Do not neglect confirmation of the position and the bearing of own ship during sailing regardless of whether automatic sailing is set to ON or OFF.

Otherwise, an accident may occur.

- 1 Click on the [Start] button of Procedure tab 2.

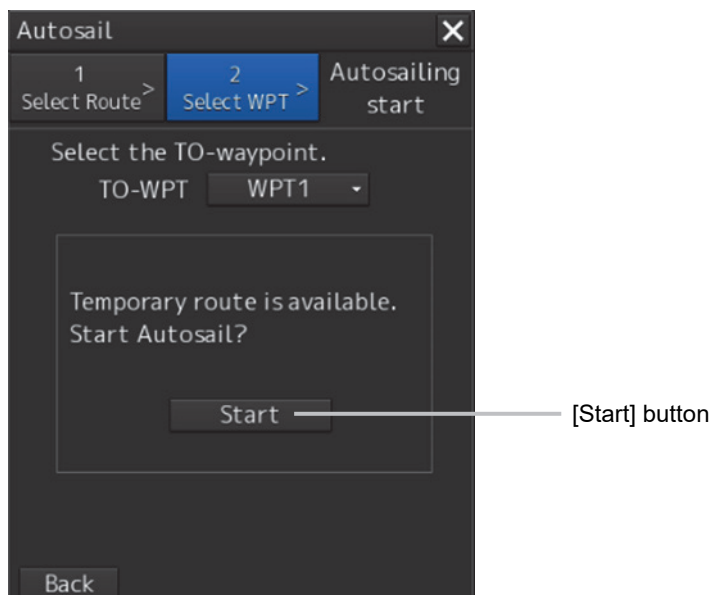

The [Auto Sail] dialog box is closed and the Autopilot steering mode switching message is displayed.

Switch the Autopilot steering mode to the NAVI mode.

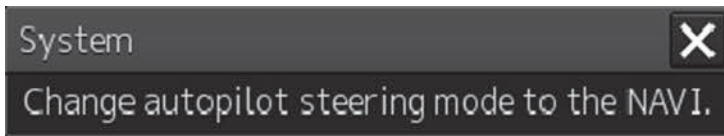

The selected planned route is displayed on the chart and the [Voyage Information] dialog is displayed.

When the [Route Planning] dialog box is opened during automatic sailing, the [Auto Sailing] (during automatic sailing) indicator is displayed on the tab of the planned route that is currently used.

The Route Planning dialog box shows a table with the following data:

| WP No | Name | Position | | Leg | | Sail | XTL | | Arrival Radius | Turn Radius | Plan Speed | ROT | ETA [YYYY-MM-DD hh:mm] | Time Zone | TTG [Days hh:mm] | Tot Dist |
|-------|------|-------------|-------------|--------|----------|------|--------|--------|----------------|-------------|------------|-----------|---------------------------|-----------|---------------------|-------------|
| | | LAT | LON | Course | Distance | | PORT | STBD | | | | | | | | |
| 0 | | 32°14.789'S | 61°29.028'E | 081.4° | 2.8NM | RL | 0.20NM | 0.20NM | 0.50NM | 0.50NM | 20.0kn | 38.2°/min | 2014-02-07 02:17 | 00:00 | 00 Days 00:08 | 2 |
| 1 | | 32°14.368'S | 61°32.295'E | 108.2° | 1.3NM | RL | 0.20NM | 0.20NM | 0.50NM | 0.50NM | 20.0kn | 38.2°/min | 2014-02-07 02:25 | 00:00 | 00 Days 00:03 | 4 |
| 2 | | 32°14.783'S | 61°33.781'E | 122.2° | 1.6NM | RL | 0.20NM | 0.20NM | 0.50NM | 0.50NM | 20.0kn | 38.2°/min | 2014-02-07 02:34 | 00:00 | 00 Days 00:04 | 5 |
| 3 | | 32°15.612'S | 61°35.333'E | 122.2° | 1.6NM | RL | 0.20NM | 0.20NM | 0.50NM | 0.50NM | 20.0kn | 38.2°/min | 2014-02-07 02:34 | 00:00 | 00 Days 00:04 | 5 |
| 4 | | 32°16.498'S | 61°36.789'E | 125.6° | 1.5NM | RL | 0.20NM | 0.20NM | 0.50NM | 0.50NM | 20.0kn | 38.2°/min | 2014-02-07 02:39 | 00:00 | 00 Days 00:04 | 7 |

[Auto Sailing] indicator

10.5 Stopping Automatic Sailing

Note

In case of JAN-7201S/9201S, automatic sailing function is not available by function restriction. Therefore the setup is not available.

- 1 Click on the [Autosail] tab of the [Voyage Information] dialog and click on the [Track Control Stop] button.

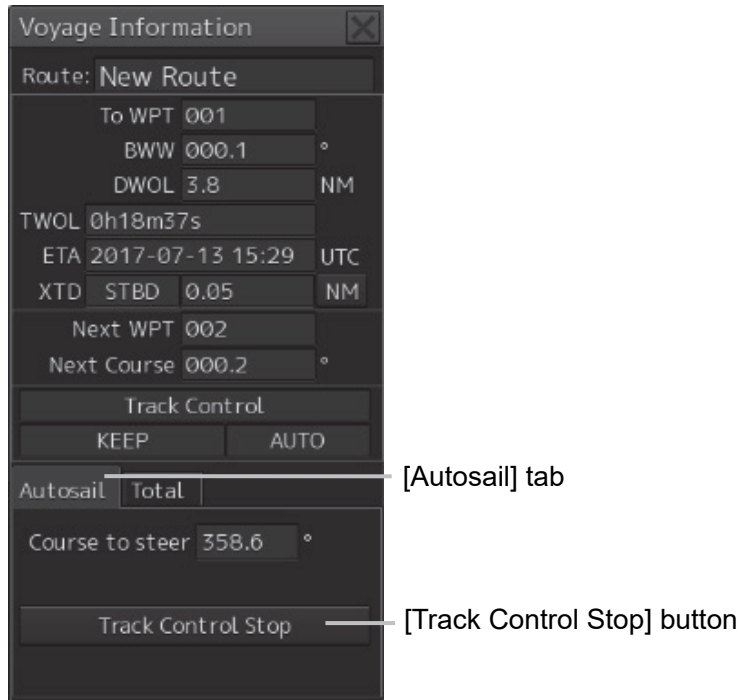

The automatic sailing stopping confirmation dialog box appears.

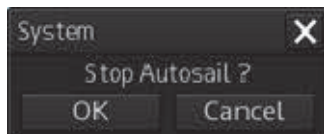

- 2 Click on the [OK] button.

Automatic sailing stops.

By the auto pilot that is installed, the auto pilot steering mode switching confirmation dialog is displayed or the mode is automatically changed to another steering mode.

For the details, refer to the Auto Pilot Instruction Manual.

10.6 Alerts at Automatic Sailing

Note

In case of JAN-7201S/9201S, automatic sailing function is not available by function restriction. Therefore the setup is not available.

The following sailing monitoring alerts may occur during automatic sailing.

| Cause | Conditions to raise | Automatic sailing | Countermeasure |
|----------------------------|--|---|---|
| Course difference warning | The actual heading deviated from the course beyond a preset course difference limit. | Can be continued | - |
| Cross Track alarm | The ship deviated from the track beyond a preset cross-track limit during the track control. | Can be continued | - |
| HDG(Sensor Failure) alarm | Heading sensor data is lost or invalid during the track control. | Stops | Switch the steering mode of AUTO PILOT to HAND. Otherwise, the current rudder angle is retained for AUTO PILOT (for details, refer to the AUTO PILOT instruction manual). |
| POSN(Sensor Failure) alarm | Position sensor data was lost or invalid during the track control. | Performs dead reckoning for 10 minutes and stops automatic sailing. | Switch the steering mode of AUTO PILOT to AUTO or HAND. Otherwise, the current course is retained for AUTO PILOT (for details, refer to the AUTO PILOT instruction manual). |
| STW(Sensor Failure) alarm | Speed sensor data is lost or invalid during the track control. | Performs dead reckoning using the last received speed value. | |
| POSN(Automatic Changed) | POSN source was automatically changed. | Can be continued | - |
| STW(Automatic Changed) | STW source was automatically changed | Can be continued | - |
| POSN(Deviation) warning | Deviation between position source exceeded beyond a preset POSN Discrepancy limit. | Can be continued | - |

| Cause | Conditions to raise | Automatic sailing | Countermeasure |
|--|---|---|--|
| Lost AP caution | A communication error occurred between Autopilot and ECDIS | Stops | Switch the steering mode of AUTO PILOT to AUTO or HAND. Otherwise, the current course is retained for AUTO PILOT (for details, refer to the AUTO PILOT instruction manual). |
| | An Autopilot failure occurred. | | Switch the steering mode of AUTO PILOT to AUTO or HAND. Otherwise, the current rudder angle is retained for AUTO PILOT (for details, refer to the AUTO PILOT instruction manual). |
| Early Course Change warning | 3-6 minutes before the wheel-over time. | Can be continued | - |
| Early course change alarm | An early course change warning was not acknowledged for 30 seconds. | | |
| Actual Course Change warning | 30 s before the wheel-over time. | Can be continued | - |
| Wheel Over Line alarm | An actual course change warning was not acknowledged for 30 seconds. | | |
| Change Autopilot steering mode warning | Position or speed sensor data is lost or invalid, causing the following errors: POSN(Sensor Failure) alarm STW(Sensor Failure) alarm Even if the warning is acknowledged, this warning will be repeated every 2 minutes during dead reckoning. | Performs dead reckoning for 10 minutes and stops automatic sailing. | Switch the steering mode of AUTO PILOT to AUTO or HAND. Otherwise, the current course is retained for AUTO PILOT (for details, refer to the AUTO PILOT instruction manual). |
| | | Performs dead reckoning using the last received speed value. | |
| End Of Track warning | 3-6 minutes before the arrival at final WP. | Stops automatic sailing after passing the final destination. | After passing the final destination, switch the steering mode of AUTO PILOT to AUTO or HAND. Otherwise, the current course is retained for AUTO PILOT (for details, refer to the AUTO PILOT instruction manual). |
| Arrived at LAST WPT alarm | An End Of Track warning was not acknowledged for 30s seconds. | | |

| Cause | Conditions to raise | Automatic sailing | Countermeasure |
|--------------------------------------|--|---|--|
| Track Control Stopped warning | After 10 minutes of DR sailing following the occurrence of POSN(Sensor Failure) | Performs dead reckoning for 10 minutes and stops automatic sailing. | Switch the steering mode of AUTO PILOT to AUTO or HAND. Otherwise, the current course is retained for AUTO PILOT (for details, refer to the AUTO PILOT instruction manual). |
| | HDG(Sensor Failure) occurred. | Stops | Switch the steering mode of AUTO PILOT to HAND. Otherwise, the current rudder angle is retained for AUTO PILOT (for details, refer to the AUTO PILOT instruction manual). |
| | An autopilot failure or a communication error occurred between Autopilot and ECDIS, causing the following errors: Lost AP caution | Stops | Switch the steering mode of AUTO PILOT to AUTO or HAND. Otherwise, when an autopilot failure occurred, the current rudder angle is retained for AUTO PILOT. When a communication error occurred between Autopilot and ECDIS, the current course is retained for AUTO PILOT. (for details, refer to the AUTO PILOT instruction manual). |
| Track Control Stopped alarm | A Track Control Stopped warning was not acknowledged for 30 seconds. | Stops | Refer to countermeasure of Track Control Stopped warning. |
| Track Control Stopped (Reboot) alarm | Equipment restarted during the track control. | | |
| POSN(Jump) caution | Position is jumped beyond a DR position (preset Radius limit). | Stop | Switch the steering mode of AUTO PILOT to HAND. |
| HDG(Unmatched Source) caution | The primary HDG sensor used by ECDIS is not the same as the primary HDG sensor used by Autopilot. | Can not start the track control | Make the primary HDG used by the autopilot and ECDIS the same. |



Section 11 Operating a Chart

Use the [Chart] menu for chart operations.

- 1 Click on the [Menu] button on the left toolbar.

The menu is displayed

- 2 Click on the [Chart] button on the menu.

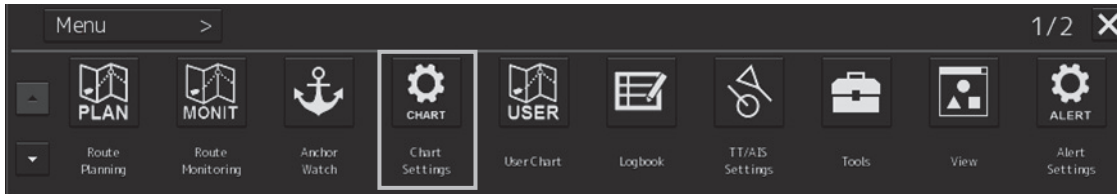

The submenu is displayed.

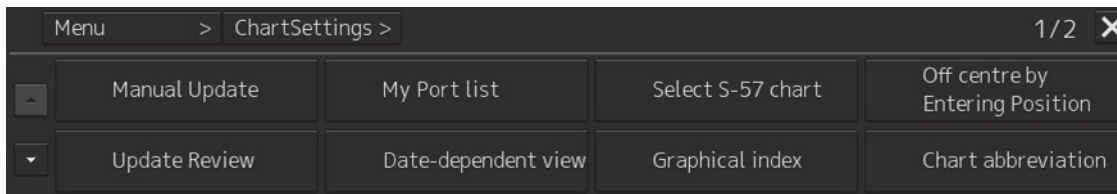

It is possible using the page switching buttons to switch to the first page and the second page of the submenu screen.

Click each button of the submenu screen to display the relevant function dialog.

| Button name | Function | Related section |
|---------------------------------|----------------------------------|---|
| First page | | |
| Manual Update | Updates a chart manually | 11.1 Updating a Chart Manually |
| My Port List | Operates a port name list | 6.7 My Port List |
| Select S-57 Chart | Selects an S-57 chart | 11.2 Displaying/Searching an S-57 Chart [Select S-57 Chart] |
| Off Center by Entering Position | Moves the display center | 11.3 Displaying a Chart by Inputting a Position |
| Update Review | Accepts the updated S-57 chart | 11.4 Confirming/Accepting/Rejecting an S-57 Updated Chart |
| Date-dependent View | Displays a date-dependent object | 11.5 Displaying a Date-dependent Object |
| Graphical Index | Displays a chart boundary | 11.6 Displaying a Chart Boundary |
| Chart Abbreviation | Chart abbreviation | 11.9 Displaying a Chart Abbreviation List |

| Button name | Function | Related section |
|--------------------------------|--|--|
| Second page | | |
| T & P (ARCS) | Enables verification of temporary/preliminary information of the ARCS chart | 11.7 Confirming Temporary/Preliminary Information of an ARCS Chart (ARCS Only) |
| Datum Offset (ARCS) | Offsets ARCS chart data | 11.8 Adjusting an ARCS Chart Position (ARCS Only) |
| Datum Transformation (ARCS) | Transforms any position of the ARCS chart and geodetic datum of the own ship's position to those of the WGS-84 | 11.8.2 Transforming a geodetic datum of an ARCS chart to WGS-84 |
| ENC Update Status Report | Displays the latest report of SENC in the system. | 11.10 Displaying an ENC Update Status Report |
| Check Applied C-MAP Updates | Displays update data of the C-MAP chart. | 11.11 Displaying update data of the C-MAP chart |
| Show C-MAP Licence Information | Displays C-MAP license information. | 11.12 Displaying license information of C-MAP |

11.1 Updating a Chart Manually

The chart can be updated manually by selecting [Chart] - [Manual Update] (chart manual update) on the menu.

For the details of manual update of a chart, refer to "12.3 Updating a Chart Manually".

11.2 Displaying/Searching an S-57 Chart [Select S-57 Chart]

11.2.1 Displaying a chart

Select S-57 Chart enables selection and display of any chart.

- 1 Click on the [Menu] button on the left toolbar.**
The menu is displayed
- 2 Click on the [Chart] - [Select S-57 Chart] on the menu.**
The [Select Chart] dialog box appears.

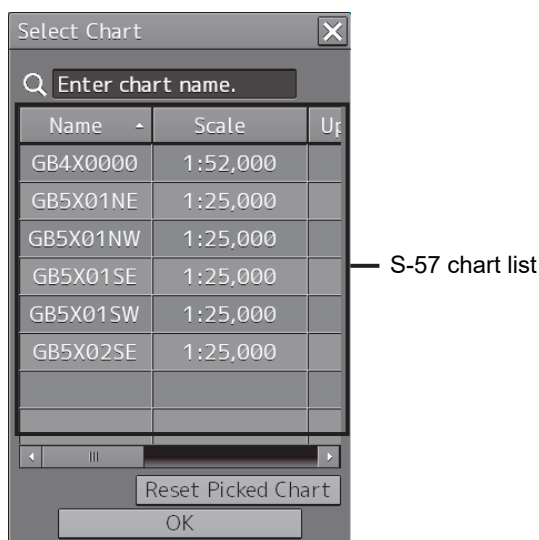

An S-57 chart list contains chart names (Name), original scales (Scale), Updating numbers (Up No.), issuing dates (Issue date), last update dates (Last Update), update acceptance statuses (Accepted, Yes: Accepted/No: Not accepted) and Rejected (update rejection status, Yes: Rejected/No: Not rejected)).

- 3 Click on the line of the chart to be displayed from the S-57 chart list.**
The chart is selected.
- 4 Click on the [OK] button.**
The selected chart is displayed on the screen.

11.2.2 Search a chart

11.2.2.1 Searching the position that is clicked on by the cursor

- 1 Click on the [Menu] button on the left toolbar.**
The menu is displayed
- 2 Click on the [Chart] - [Select S-57 Chart] on the menu.**
The [Select Chart] dialog box appears.
- 3 Move the cursor to the position to be searched and click the mouse button.**
The chart that is set at the position specified by clicking the mouse button is displayed in the S-57 chart list.

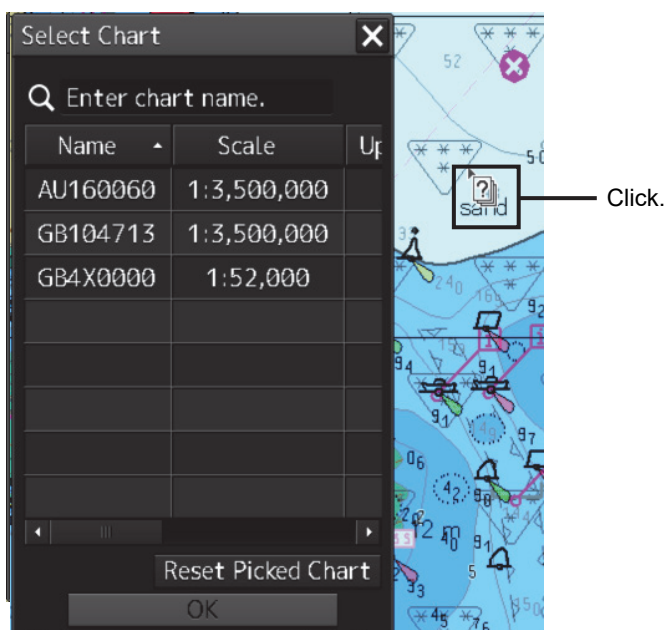

Clearing search results

Click on the [Reset Picked Chart] (chart selection reset) button.

11.2.2.2 Searching by using a chart name

- 1 Click on the [Menu] button on the left toolbar.**
The menu is displayed
- 2 Click on the [Chart] - [Select S-57 Chart] on the menu.**
The [Select Chart] dialog box appears.
- 3 Enter a chart name in the search box**

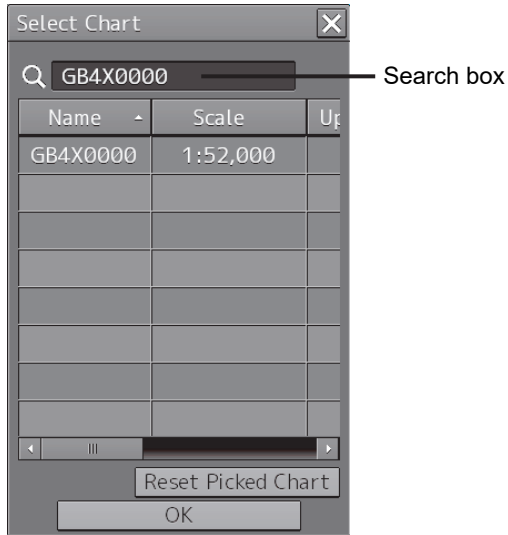

The chart is displayed.

Clearing search results

Clear by using the [DEL] key on the software keyboard.

11.3 Displaying a Chart by Inputting a Position

By inputting a position, the chart of the position that was input can be displayed.

- 1 Click on the [Menu] button on the left toolbar.**

The menu is displayed

- 2 Click on the [Chart] - [Off Center by Entering Position] on the menu.**

The [Off Center by Entering Position] dialog box appears.



- 3 Enter a position of the chart to be displayed in the latitude/longitude input box.**

- 4 Click on the [Jump to the following position] button.**

The chart of the specified position is displayed.

11.4 Confirming/Accepting/Rejecting an S-57 Updated Chart

The update contents of an S-57 updated chart can be confirmed.

By accepting an updated chart, the updated chart can be integrated into the original chart.

Note

Check that the display category of the chart is [Standard] or [All].

When the display category is set to [Base], the updated chart may not be displayed.

1 Click on the [Menu] button on the left toolbar.

The menu is displayed.

2 Click on the [Chart] - [Update Review] on the menu.

The [Update Review] dialog box appears.

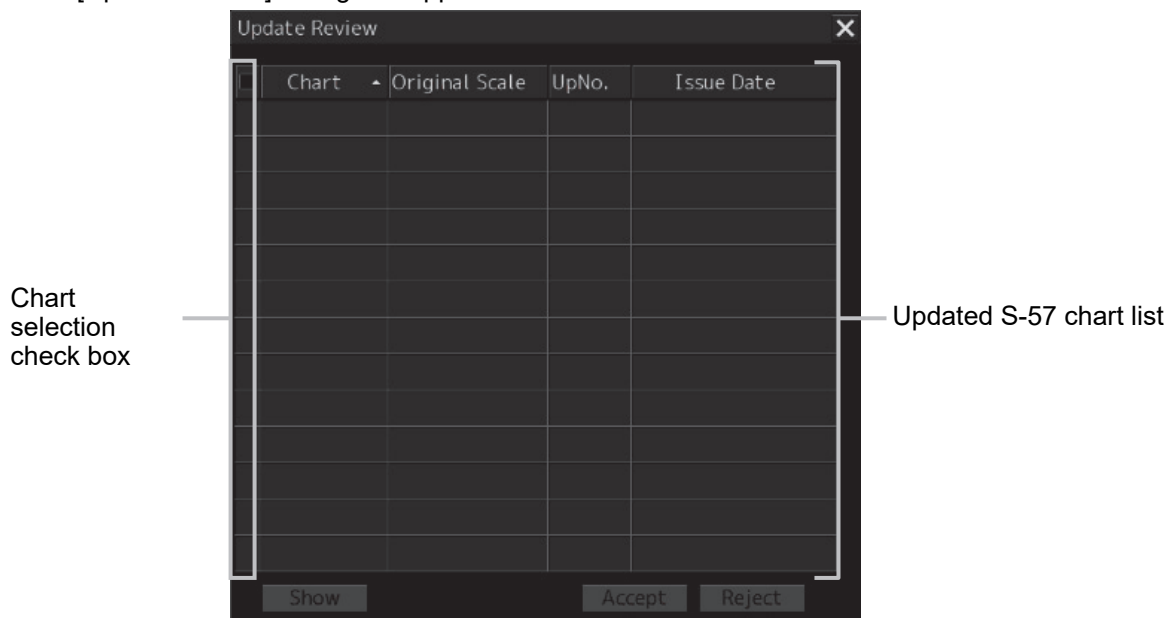

3 To confirm the update contents of the updated chart, select the check box of the chart and click on the [Show] (display) button.

The selected updated chart is displayed. The updated chart is displayed on the original chart in red.

4 Click on the [Accept] button to accept the updated chart.

The updated chart is integrated into the original chart.

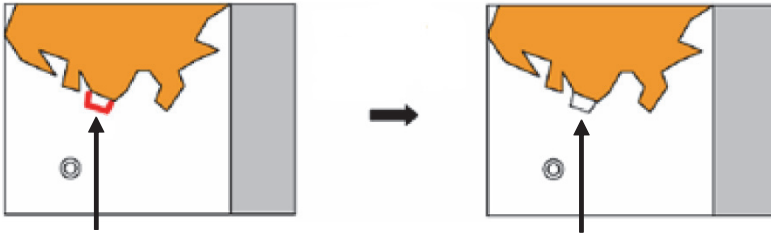

Click on the [Show] button:
A highlight marker is displayed
on the object to be updated.

Click on the [Accept] button: The
object is accepted and only the
updated object is displayed.

For the details of the highlight indication, refer to 11.14 Displaying differences at chart update.

5 To reset the updated chart to the pre-update state, select two or more target charts from the list and click on the [Reject] button.

When the [Reject] button is clicked on, the automatic update of the chart is rejected and the chart is reset to the pre-update state.

After the Reject operation, a rejection marker is displayed on the target object.

For the details of the rejection indication, refer to 11.3 Displaying differences at chart update.

11.5 Displaying a Date-dependent Object

A chart object of the specified date and time can be displayed.

For instance, it is possible to display a date-dependent chart such as displaying a chart at the arrival time of the arrival schedule at the navigation planning.

- 1 Click on the [Menu] button on the left toolbar.**

The menu is displayed

- 2 Click on the [Chart] - [Date-dependent View] on the menu.**

The [Date-dependent View] dialog box appears.

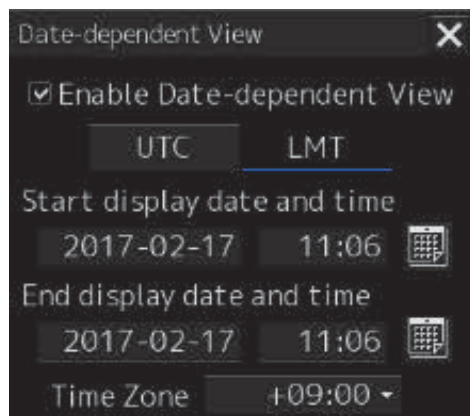

- 3 Set the [Enable Date-dependent View] check box to ON.**

If the screen is closed while the check box is set to OFF, the date-dependent object is not displayed.

- 4 Set the [UTC] (Universal Time Coordinated) button or [LMT] (Local Mean Time) button to On by clicking on the button.**

- 5 Enter a date (within the range from 1980-01-01 to 2099-12-31) and a time in the [Start display date and time] input box.**

- 6 Enter a date (within the range from 1980-01-01 to 2099-12-31) and a time in the [End display date and time] input box.**

- 7 When [LMT] is set to On in Step 4, enter a time difference in [Time Zone] box within the range from -13:30 to +13:30.**

The object displayed on the chart is updated when information is input in any of the steps from Step 5 to Step 7.

- 8 Close the [Date-dependent View] dialog box.**

Displaying an indication in duration specification

When the duration specification of the object is different from the current date while a date-dependent object is displayed, the [Display Not Real Time] dialog screen is displayed.

When the duration specification matches the current date, the [Display Not Real Time] dialog screen is not displayed since no warning is necessary.

Display Not Real Time

Display is based on viewing date range
from 2016-12-09(UTC) to 2016-12-25(UTC)

In the specified date and time, (UTC) is displayed for (LMT) under UTC and the Time Zone is not displayed.

For duration specification for a route plan by ETA, the duration is always displayed under UTC.

When a route plan is displayed, the Date-dependent View screen is closed and Date-dependent View on the menu is set to Disable. (This is because the priority is given to the duration specification for a route plan by ETA.)

Note

While displaying a route in a route plan, the [Display Not Real Time] dialog box is always displayed if the specified duration is different from the current date.

11.6 Displaying a Chart Boundary

The boundary of the chart on the position on which the button was clicked is displayed.

11.6.1 Setting a boundary to be displayed on the chart

A chart boundary can be displayed.

1 Click on the [Menu] button on the left toolbar.

The menu is displayed.

2 Click on the [Chart] - [Graphical Index] on the menu.

The [Graphical Index] dialog box appears.

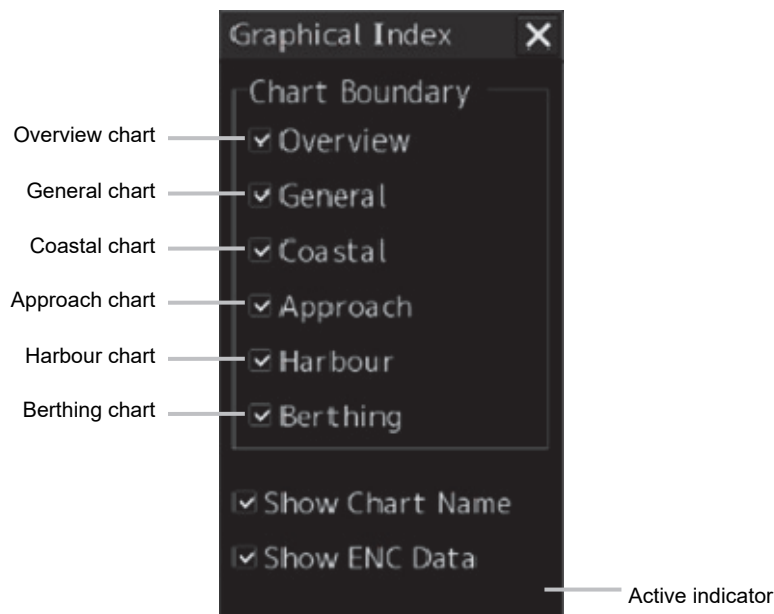

3 Select the chart whose boundary is to be displayed among the [Chart Boundary] check boxes.

4 To display the chart name in addition to the boundary, select [Show Chart Name].

5 To display ordinary chart information in addition to the boundary, select [Show ENC Data] (displaying chart information).

When this item is not selected, the background chart is displayed.

Memo

While C-MAP is displayed, [Show ENC Data] is not displayed.

Active indicator ()

Although the operation of each check box is enabled while the active indicator is displayed, a chart boundary line is not displayed.

When the active indicator is hidden, a boundary line is displayed.

11.6.2 Displaying chart information

When the chart is clicked on while the [Graphical Index] dialog box is displayed, the chart information on the location that was clicked on is displayed in "Edition and date of chart".

Memo

"Edition and date of chart" is not displayed while the active indicator is displayed in the [Graphical Index] dialog box even if the chart is clicked on.

Information of the chart of the location that was clicked on

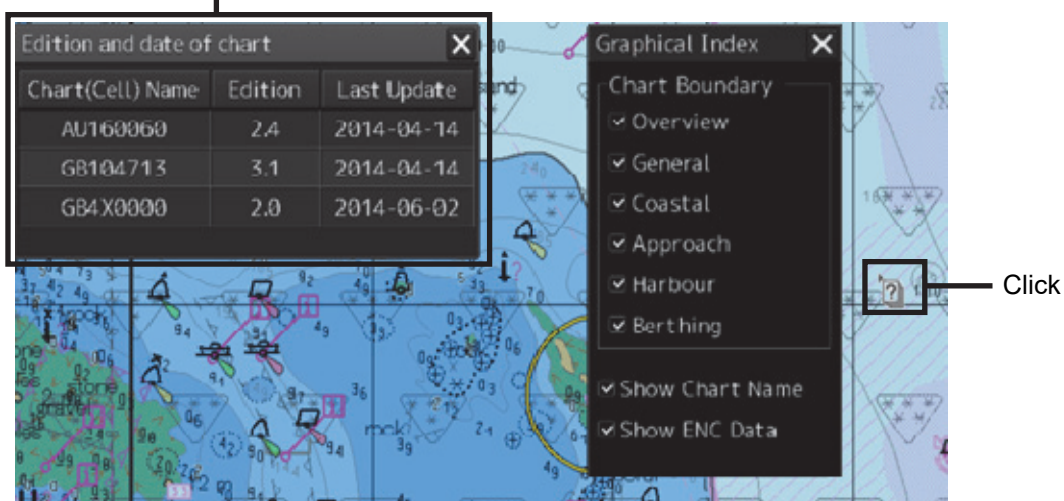

11.7 Confirming Temporary/Preliminary Information of an ARCS Chart (ARCS Only)

Temporary/preliminary information (T&P: Temporary and Preliminary Notices) of an ARCS chart can be confirmed.

- 1 Click on the [Menu] button on the left toolbar.

The menu is displayed.

- 2 Click on the [Chart] - [T&P] on the menu.

The [T&P] dialog box appears.

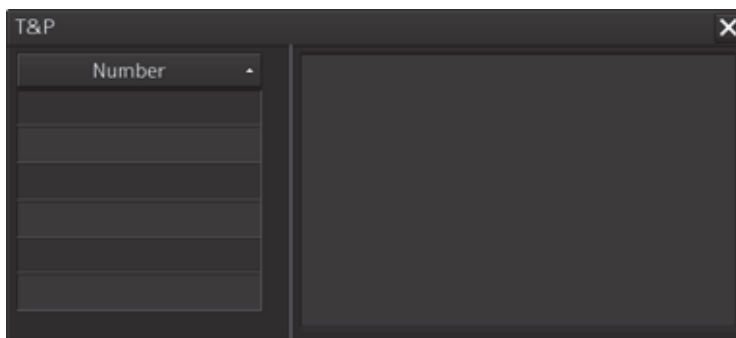

- 3 Click on the number whose contents are to be confirmed on the [Number] list.

The temporary/preliminary information of the chart of the specified number is displayed on the right side.

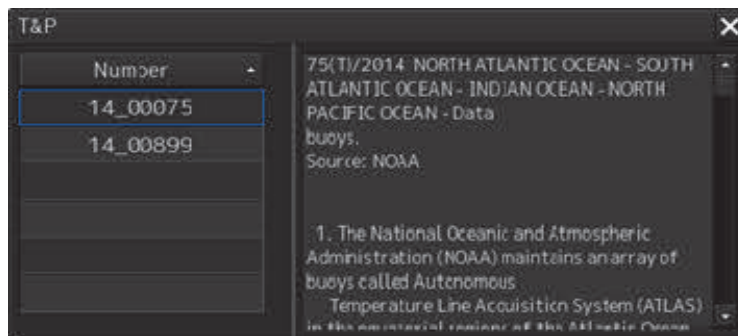

The list can be sorted by clicking on any item of the title column.

Note

Temporary/preliminary information is included in the ARCS chart itself. Since the information may not be included depending on the chart, the information may not be displayed.

11.8 Adjusting an ARCS Chart Position (ARCS Only)

Note

Adjust the offset only when the geodetic datum of the chart is a local geodetic datum and the display position is not adjusted correctly.

11.8.1 Offsetting an ARCS chart

Move the chart by entering offset values (latitude and longitude) or using the cursor.

- 1 Click on the [Menu] button on the left toolbar.
The menu is displayed.
- 2 Click on the [Chart] - [Datum Offset] (geodetic offset) on the menu.
The [Datum Offset] (geodetic offset) dialog box appears.



When the previous setting values are displayed in the [Offset] box, the values can be cleared by clicking on the [Clear Offset] button.

To set offset of a chart, use the cursor or enter offset values.

Offsetting a chart with the cursor

- 1 Click on the [Offset by Cursor] button.
The button display changes to On and the offset function is enabled.

Offset by Cursor

- 2 Set the cursor to the reference point and click the mouse button.
To clear the offset values, set the button to Off by clicking on the [Offset by Cursor] button.

3 Place the cursor on the offset position and click the mouse button.

The reference point moves to the offset position.

A check mark () is displayed on the [Offset] display (start of offset).

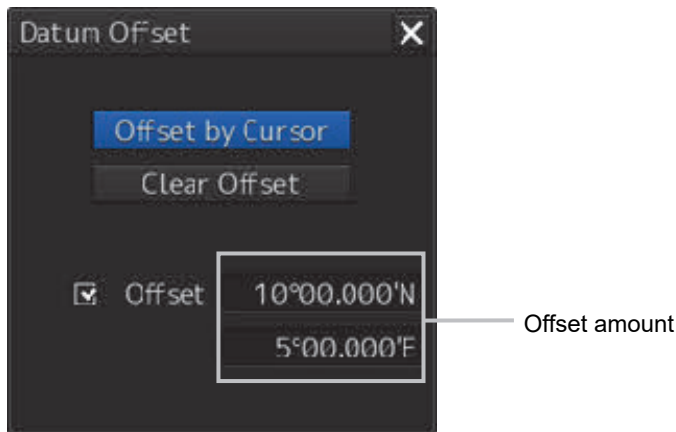

Offsetting a chart by entering an offset value

1 Enter offset values (latitude/longitude) in the [Offset] box.

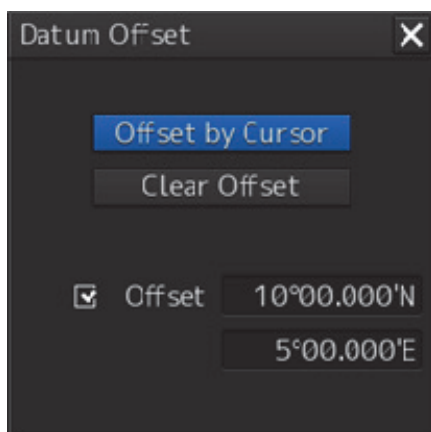

The chart is offset.

Memo

The maximum latitude input range is 85 ° 00.000 (Maximum range of latitude that can be operated during ECDIS mode).

11.8.2 Transforming a geodetic datum of an ARCS chart to WGS-84

A geodetic datum of an ARCS chart can be transformed to WGS-84 based on any position and the own ship's position.

- 1 Click on the [Menu] button on the left toolbar.

The menu is displayed.

- 2 Click on the [Chart] - [Datum Transformation] (geodetic datum transformation) on the menu.

The [Datum Transformation] (geodetic datum transformation) dialog box appears.

Datum Transformation

Geodetic Datum

From

To WGS84

Reference Position

Position

Ship Position

Chart Shift

Reference Position

Position

Shifted Position

Position

Note

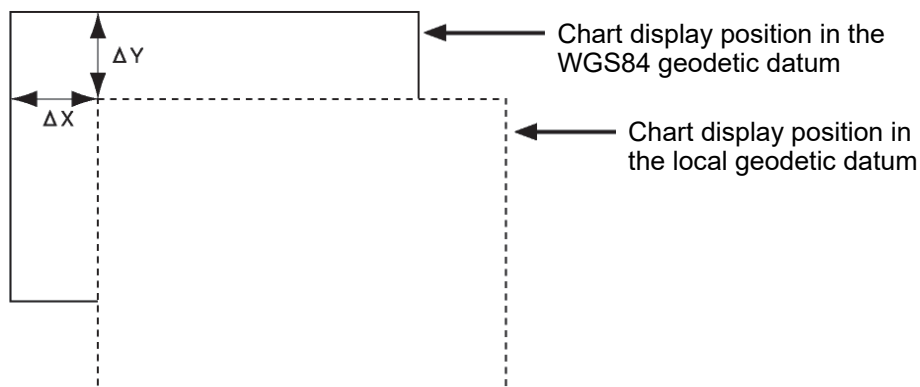

ΔX and ΔY : Offset amount to WGS84

When ΔX and ΔY are included in the chart information, the system automatically offsets the amount to WGS84 and displays the result. In this case, a check mark is attached to RNC Offset of "Chart Information Area(RNC)" and "Chart Shift to WGS84" is displayed in the alert notification area.

As shown above, even if the offset amount is determined in the [Datum Transformation] dialog box for the chart that is displayed under WGS-84 and the [OK] button is clicked on, this function is disabled and the message, "The Datum is already WGS-84", is displayed.

3 Select a geodetic system from the [From] combo box of [Geodetic Datum].

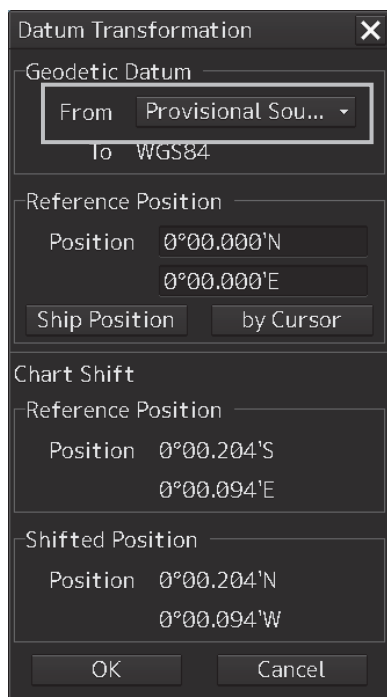

Memo

For the geodetic datum that is displayed in the [From] combo box, refer to "D.3 Geodetic datum abbreviations". However, "No Use" in No.9, No.10, No.48 and No.49 is not displayed.

4 Enter a latitude and a longitude in the [Position] input boxes of [Reference Position].

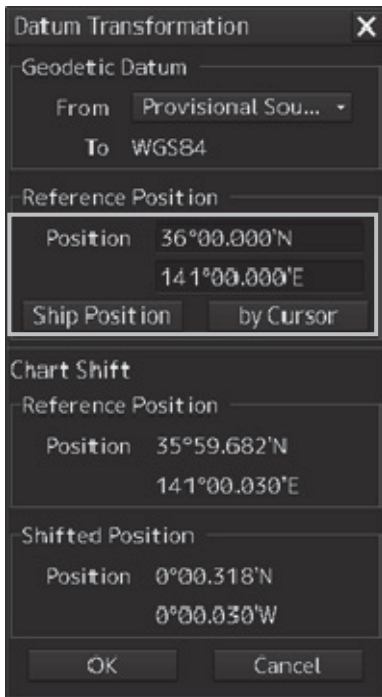

When the [Ship Position] button is clicked on, the latitude and the longitude of the own ship's position is displayed in the [Position] input boxes.

When the [by Cursor] button is clicked on, the cursor changes to the offset cursor. When the mouse button is clicked on the chart, the latitude and longitude of the point on which the mouse button was clicked is displayed in the input boxes.

Information after transformation is displayed on [Chart Shift].

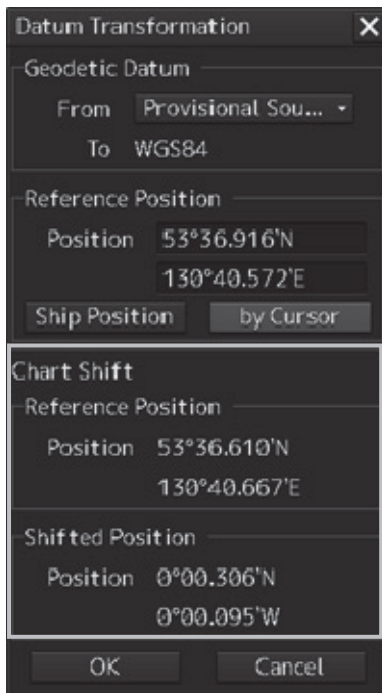

The position shifted after geodetic datum transformation is displayed in [Reference].
The offset amount after geodetic datum transformation is displayed in [Shifted Position].

5 Click on the [OK] button.

The transformation is determined.

11.9 Displaying a Chart Abbreviation List

A list describing chart abbreviations can be displayed.

- 1 Click on the [Menu] button on the left toolbar.**
The menu is displayed.
- 2 Click on the [Chart] - [Chart Abbreviation] on the menu.**
The [Chart Abbreviation] dialog box appears.

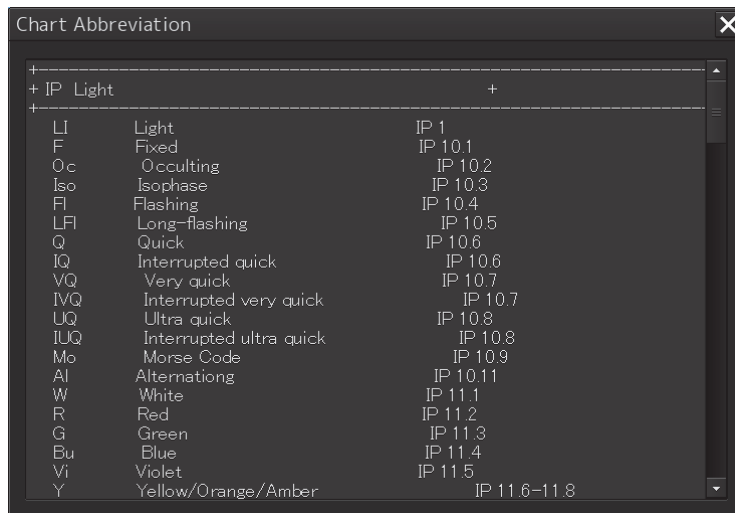

11.10 Displaying an ENC Update Status Report

This function displays the latest report of SENC within the system.

This function also displays the latest report of SENC relating to the specified route.

- 1 Click on the [Menu] button on the left tool bar.
- 2 Click on [Chart] – [ENC update status report] on the menu.

The [ENC update status report] dialog is displayed.

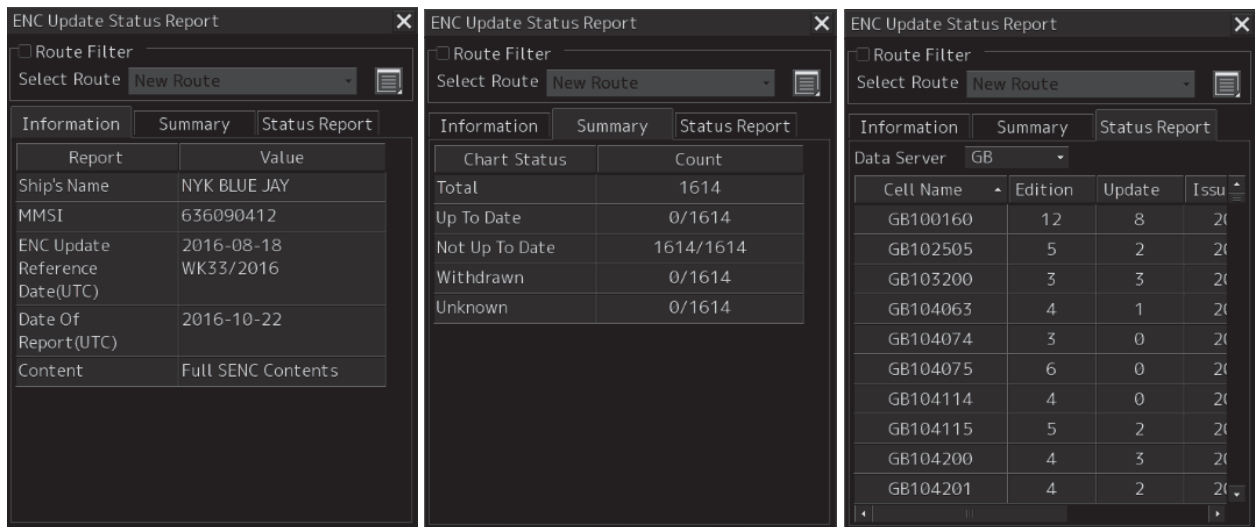

Set the [Route filter] check box to ON and select a route on the [Select Route] combo box.

The update report relating to the selected route (Route filtered ENC update status report) is displayed, the list items that are displayed by each tab increase, and the contents change.

The details of the items that are displayed by each tab are shown below.

Contents displayed by the Information tab

| No. | Item | Operation/Condition | Input range/Default value |
|-----|-------------|---|--|
| 1. | Ship's Name | [Operation] Displays the name of own ship that was entered by selecting Service->Installation->Ship's Parameter->Ship General->Ship's Name. | [Display range] Up to 20 characters (Same as for Ship General->Ship's Name) |
| 2. | MMSI | [Operation] Displays MMSI of own ship, which is the same as that displayed by selecting TT/AIS->Own Ship AIS Data->MMSI. | [Display range] Up to 9 characters (Same as for TT/AIS->Own Ship AIS Data->MMSI) [Default value] Blank space |

| No. | Item | Operation/Condition | Input range/Default value |
|-----|---------------------------|--|---|
| 3. | Enc update reference date | <p>[Operation]</p> <p>Displays a media time stamp in the following format.</p> <p>Latest date that was retrieved from the S-63SERIAL.ENC file.</p> <p>The display style complies with the style that was selected on the Date/Time screen.</p> | <p>[Display range]</p> <p>YYYY-MM-DD</p> <p>MMM DD,YYYY</p> <p>DD MMM,YYYY</p> |
| 4. | Date of report | <p>[Operation]</p> <p>Displays the year, month, and day when the ENC update status report screen is displayed.</p> <p>The display style complies with the style that was selected on the Date/Time screen.</p> | <p>[Display range]</p> <p>YYYY-MM-DD</p> <p>MMM DD,YYYY</p> <p>DD MMM,YYYY</p> |
| 5. | Content | <p>[Operation]</p> <p>Displays the following character string.</p> <ul style="list-style-type: none"> • ENC update status report: Full SENC contents • Route filtered ENC update status report: Filtered for route plan. | |
| 6. | Start WPT Name | <p>[Operation]</p> <p>Displays the following character string.</p> <ul style="list-style-type: none"> • Route filtered ENC update status report: <Start WPT name> <p>*When no name is set, [WPT<WPT number>] is displayed.</p> <p>[Condition]</p> <ul style="list-style-type: none"> • ENC update status report: No item is displayed. | |
| 7. | End WPT Name | <p>[Operation]</p> <p>Displays the following character string.</p> <ul style="list-style-type: none"> • Route filtered ENC update status report: <End WPT name> <p>*When no name is set, [WPT<WPT number>] is displayed.</p> <p>[Condition]</p> <ul style="list-style-type: none"> • ENC update status report: No item is displayed. | |

| No. | Item | Operation/Condition | Input range/Default value |
|-----|-------------------|--|---------------------------|
| 8. | Start WPT Positon | <p>[Operation]</p> <p>Displays the following character string.</p> <ul style="list-style-type: none"> •Route filtered ENC update status report: <Latitude>, <Longitude> <p>*Latitude and longitude of the start WPT Example: 57°46.5636'S, 11°58.0000'E</p> <p>[Condition]</p> <ul style="list-style-type: none"> •ENC update status report: No item is displayed. | |
| 9. | End WPT Positon | <p>[Operation]</p> <p>Displays the following character string.</p> <ul style="list-style-type: none"> •Route filtered ENC update status report <Latitude>, <Longitude> <p>*Latitude and longitude of the end WPT Example: 54° 20.0147'S , 10° 09.3458'E</p> <p>[Condition]</p> <ul style="list-style-type: none"> •ENC update status report: No item is displayed. | |

Contents displayed by the Summary tab

| No. | Item | Operation/Condition | Input range/Default value |
|-----|----------------|---|---------------------------|
| 1. | Total | <p>[Operation]</p> <p>Displays the total number of cells.</p> | |
| 2. | Up To Date | <p>[Operation]</p> <p><Number of Up to date cells>/<Total number></p> <p>Up to date: Latest update data that is displayed in the latest PRODUCTS.TXT. When the data exceeded four weeks old, Not Up to Date is displayed.</p> | |
| 3. | Not Up To Date | <p>[Operation]</p> <p><Number of Not Up to Date cells>/<Total number></p> <p>Not up to date: Not the latest update data that is indicated in the latest PRODUCTS.TXT. Alternatively, the ENC Update Reference Date is the date four weeks prior to the date of the Date of Report.</p> | |
| 4. | Withdrawn | <p>[Operation]</p> <p><Number of Withdrawn cells>/<Total number></p> <p>Withdrawn: Cells that have been withdrawn (does not exist in PRODUCTS.TXT) or have been cancelled.</p> | |

| No. | Item | Operation/Condition | Input range/Default value |
|-----|---------|--|---------------------------|
| 5. | Unknown | <p>[Operation]</p> <p><Number of Unknown cells>/<Total number></p> <p>Unknown: PRODUCTS.TXT is PARTIAL and cell information is not available.</p> | |

Contents displayed by the Status report tab

| No. | Item | Operation/Condition |
|-----|-----------------------|--|
| 1. | Data Server combo box | <p>[Operation]</p> <p>Select a country code. (Example: GP, JP, or so on)</p> <p>The list length of the combo box is variable.</p> <p>[Condition]</p> <p>Display is disabled when there are no options.</p> |
| 2. | Cell Name | <p>[Operation]</p> <p>Displays the cell name.</p> |
| 3. | Edition | <p>[Operation]</p> <p>Displays the edition of the cell.</p> <p>For the edition of the cell that has not been imported, the edition of the PRODUCTS.TXT is used.</p> |
| 4. | Update | <p>[Operation]</p> <p>Displays the update number.</p> <p>For the update number of the cell that has not been imported, the number of the PRODUCTS.TXT is used. (Latest Update Number)</p> |
| 5. | Issue Date | <p>[Operation]</p> <p>Displays the cell issue date.</p> <p>For the issue date of the cell that has not been imported, the date of PRODUCTS.TXT is used. (Issue Date Latest Update)</p> <p>The display style complies with the style that was selected on the Date/Time screen.</p> |
| 6. | Expiry Date | <p>[Operation]</p> <ul style="list-style-type: none"> Route filtered ENC update status report: <ul style="list-style-type: none"> Displays the expiry date. <p>The display style complies with the style that was selected on the Date/Time screen.</p> <p>[Condition]</p> <ul style="list-style-type: none"> ENC update status report: <ul style="list-style-type: none"> No item is displayed. |

| | | |
|----|--------|--|
| 7. | Status | <p>[Operation]</p> <p>Displays one of the following statuses.</p> <ul style="list-style-type: none"> • Up to date • Not up to date • Withdrawn • Unknown |
| 8. | Action | <p>[Operation]</p> <ul style="list-style-type: none"> • Route filtered ENC update status report: Displays one of the following actions. <ul style="list-style-type: none"> • Renew: The permit will expire in less than 30 days. • To be ordered: Although the cell range that is indicated in PRODUCTS.TXT intersects with the route, there is no permit. • No action: The permit is effective for 30 days or longer. • To be removed: A cell is not found from the FULL PRODUCTS.TXT or it has been cancelled. • To be installed: Although the cell range that is indicated in PRODUCTS.TXT intersects with the route and the permit is available, it has not been imported. <p>[Condition]</p> <ul style="list-style-type: none"> • ENC update status report: No item is displayed. |

11.11 Displaying update data of the C-MAP chart

Update data of the C-MAP chart can be displayed.

- 1 Click on the [Menu] button on the Left Tool Bar.

A menu is displayed.

- 2 Click on [Chart]-[Check Applied C-MAP Updates](C-MAP update confirmation) on the menu.

The [Check Applied C-MAP Updates] (C-MAP update confirmation) dialog is displayed.

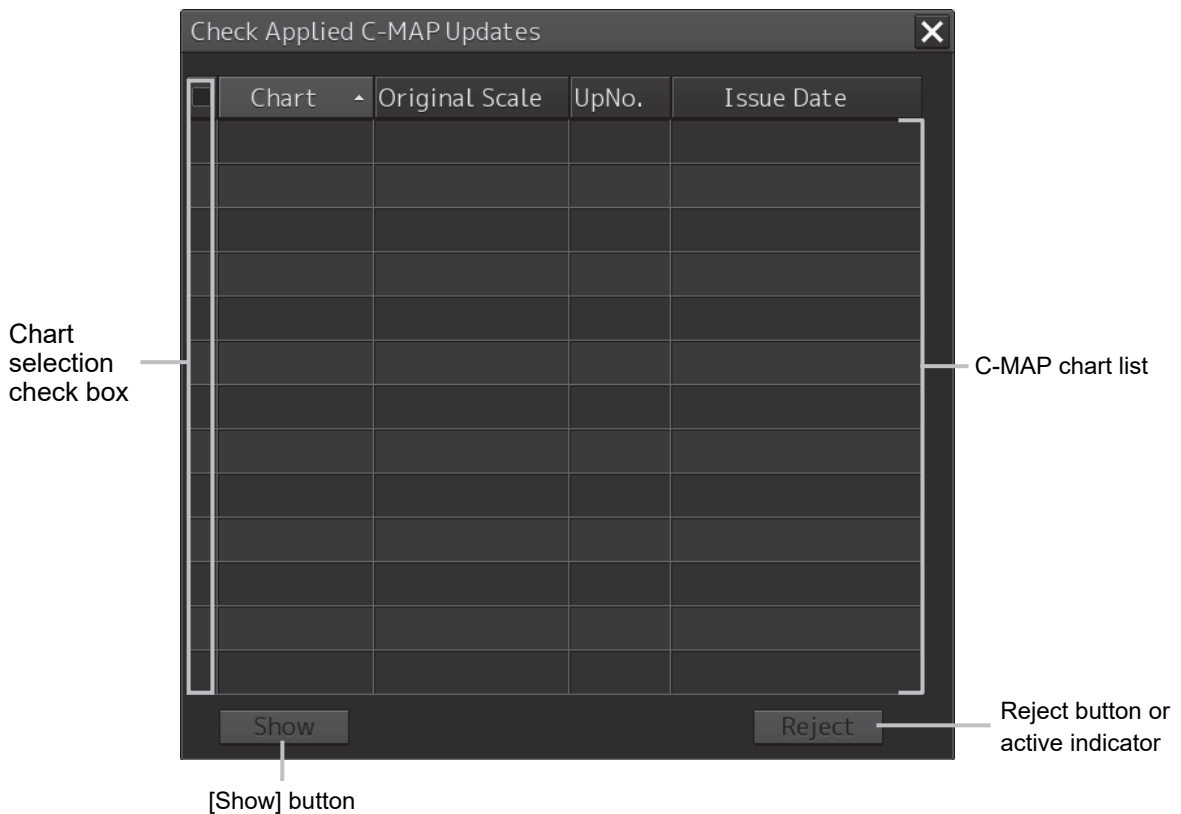

The C-MAP chart list includes Chart (chart name), Original Scale, Up No. (update number), Issue Date, Last Update (chart update date), and Accepted (update approval status).

For the Last Update, the same date as the Issue Date is displayed and Accepted is fixed to [Yes] display.

Memo
The C-MAP chart list is not displayed while the active indicator is displayed. Only the moving of the [Check Applied C-MAP Updates] dialog and Close operation are enabled. When the C-MAP chart list is displayed, the active indicator is hidden.

3 Click on the row of the chart to be displayed from the C-MAP chart list.

The chart is selected.

4 Click on the [Show] button.

The selected chart is displayed at the center of the screen and a red line is displayed at the cell boundary.

The updated object is displayed in highlight mode.

5 To reset the updated chart to the pre-update state, select two or more target charts from the list and click on the [Reject] button.

When the [Reject] button is clicked on, the automatic update of the chart is rejected and the chart is reset to the pre-update state.

6 Close the [Check Applied C-MAP Updates] dialog.

The red line at the cell boundary is cleared and the highlighted display of the updated object also terminates.

The following objects can not be rejected with C-MAP.

- Depth area
- Dredged area
- Floating dock
- Hulk
- Land area
- Pontoon
- Unsurveyed area

Note

The [Check Applied C-MAP Updates] dialog is displayed only when only one check is ON in C-MAP Ed 3 Database of [View-Option] - [Chart Common].

Otherwise, this dialog is not displayed.

When multiple checks are ON for C-MAP Ed3 Database in [View-Option] - [Chart Common], clicking [Menu] - [Chart] - [Check Applied C-MAP Updates] opens the popup shown below and [Chart Common] dialog.

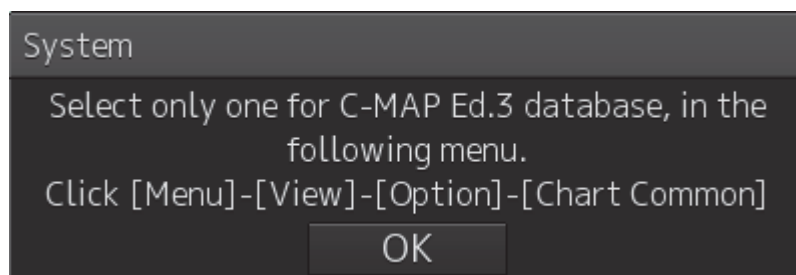

11.12 Displaying license information of C-MAP

C-MAP license information can be displayed on a popup window of the RADAR and ECDIS screens.

11.12.1 Setting license information display to ON

- 1 Click on the [Menu] button of the Left Tool Bar.**

A menu is displayed.

- 2 Click on [Chart]-[Show C-MAP License Information] (C-MAP license information display) on the menu.**

A license information display turned on and a popup window indicating C-MAP license information of C-MAP is displayed.

For the details, refer to “11.12.2 C-MAP license information”.

11.12.2 C-MAP license information

11.12.2.1 License information display timing

When license information display is set to ON, the C-MAP license status is checked at the following timing and related information is displayed on a popup window of the RADAR or ECDIS screen.

| Timing | Operation |
|---|--|
| [Chart]-[Show C-MAP License Information] are selected on the menu. | <ul style="list-style-type: none"> • Always a popup window is displayed. • The static license is displayed. • The dynamic license is displayed if it has been activated. |
| The RADAR/ECDIS task is started. | <ul style="list-style-type: none"> • When Chart Type of [View1] or [View2] is set to C-MAP3 on the [View Options] dialog that is displayed by selecting [View]-[Options]-[Chart View] on the menu, a popup window is displayed if the condition is satisfied. • Although the static license is displayed, it is not displayed if there is ample time until the expiration of the static license. • The dynamic license is displayed if it has been activated. |
| The date of the UTC time is changed while the RADAR/ECDIS task is active. | <ul style="list-style-type: none"> • When Chart Type of [View1] or [View2] is set to C-MAP3 on the [View Options] dialog that is displayed by selecting [View]-[Options]-[Chart View] on the menu, a popup window is displayed if the condition is satisfied. • Although the static license is displayed, it is not displayed if there is ample time until the expiration of the static license. • The dynamic license is displayed if it has been activated. |
| The Chart Type setting of [View1] or [View2] is changed in the [View-Options] dialog by selecting [View]-[Options]-[Chart View] in the menu | <ul style="list-style-type: none"> • When Chart Type is changed to C-MAP3 from any other types, a popup window is displayed when the condition is satisfied. • Although the static license is displayed, it is not displayed if there is ample time until the expiration of the static license. • The dynamic license is not displayed. |

How to read the popup display

See below for an example of a popup window that indicates C-MAP license information and how to read the information.

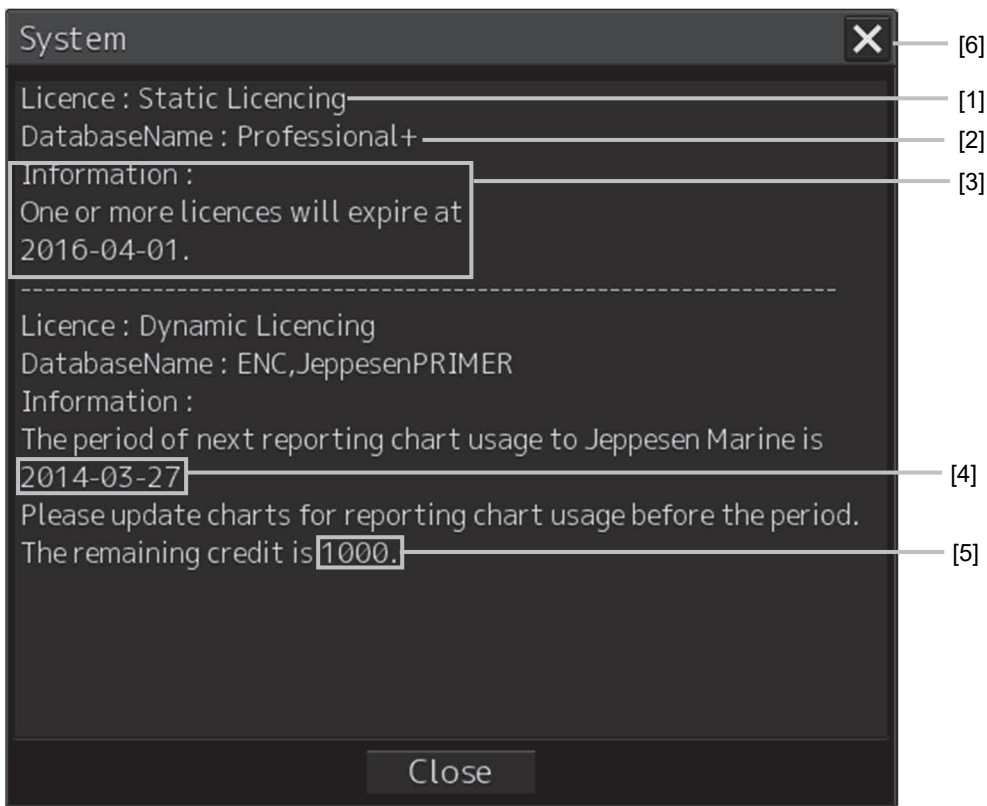

[1] License format

Static Licensing: Static license
Dynamic Licensing: Dynamic license

[2] Database name

[3] License information

Refer to “11.12.2.2 License information”.

[4] Reporting expiration date

[5] Remaining number of credits

[6] [X](Close) button

Click on this button to close the popup window.

11.12.2.2 License information

The following information is displayed in a popup window of the C-MAP license information.

| License status | Information that is displayed |
|---|---|
| The dynamic license has been activated. | The period of next reporting chart usage to Jeppesen Marine is [Reporting expiration date]. Please update charts for reporting chart usage before the period. The remaining credit is [Remaining number of credits]. |
| The dynamic license usage reporting has expired. | The period of next reporting chart usage to Jeppesen Marine has expired. You cannot access to new charts and non-reported charts. Please update charts for reporting chart usage. The remaining credit is [Remaining number of credits]. |
| There is ample time until the expiration of the static license. | One or more licences will expire at [Date]. |
| The static license will expire within less than 2 months. | One or more licences will expire at [Date]. Please contact your Jeppesen Marine agent for a licence renewal. |
| The static license has expired. | One or more licences expired. Please contact your Jeppesen Marine agent for a licence renewal. |
| The license has not been imported. | No licence installed. |

11.13 Displaying ECDIS Chart 1

ECDIS Chart 1 can be displayed on the ECDIS screen.

By displaying ECDIS Chart 1, you can check whether new symbols introduced in IHO S-52 Presentation Library version 4.0 can be displayed.

As a matter of specification, Chart 1 must be installed in all ECDIS.

11.13.1 Displaying ECDIS Chart 1

Import Chart data of ECDIS Chart 1 from [Chart Maintenance] of the task menu.

The storage locations of chart data of S-57 and C-MAP are as follows.

【S-57】

"D:\MFD\system\ECDIS_Chart_1"

【C-MAP】

"D:\MFD\system\C-MAP_Chart_1"

For the chart import procedure, refer to a separate manual, "Additional Instruction Manual for Introducing Chart".

11.13.2 Confirm display of ECDIS Chart 1

- 1 Click MENU-[Chart]-[ECDIS Chart 1] to display the [ECDIS Chart 1] dialog.

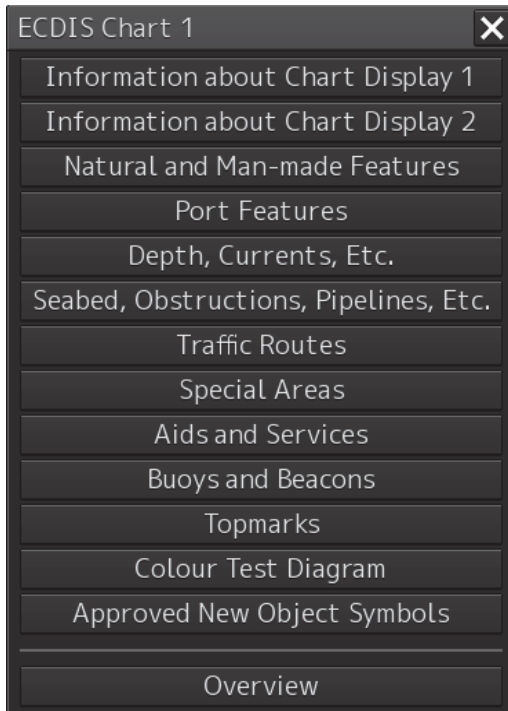

- 2 Click each button to display Chart 1.

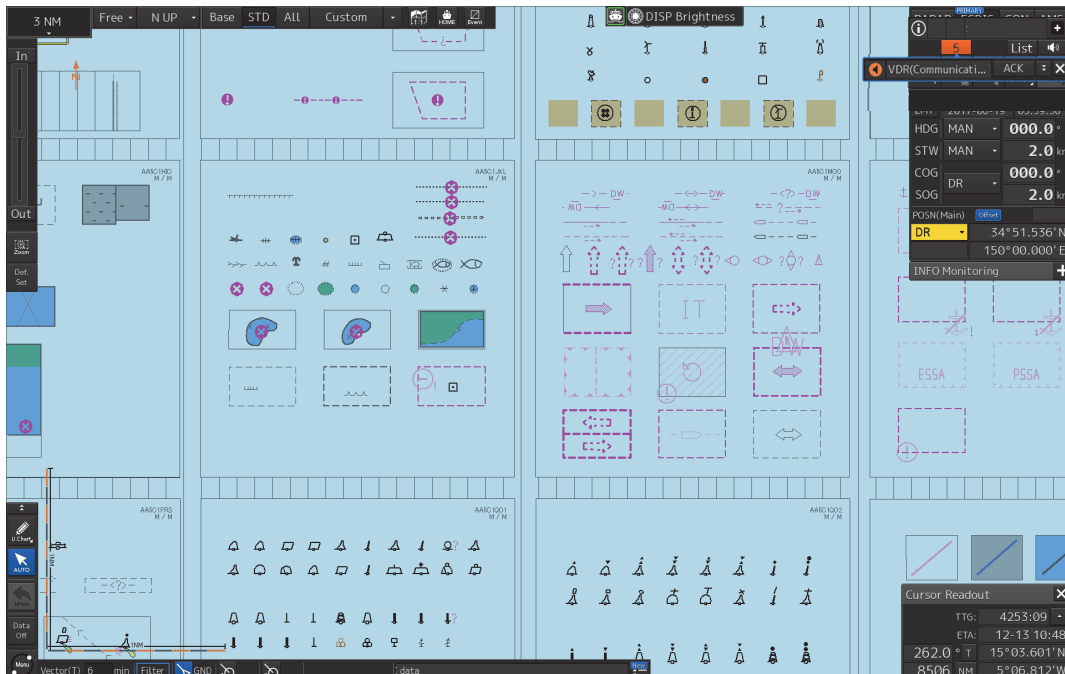

Memo

If ECDIS Chart 1 is not imported, a message prompting the import of the chart will be displayed when clicking the button.

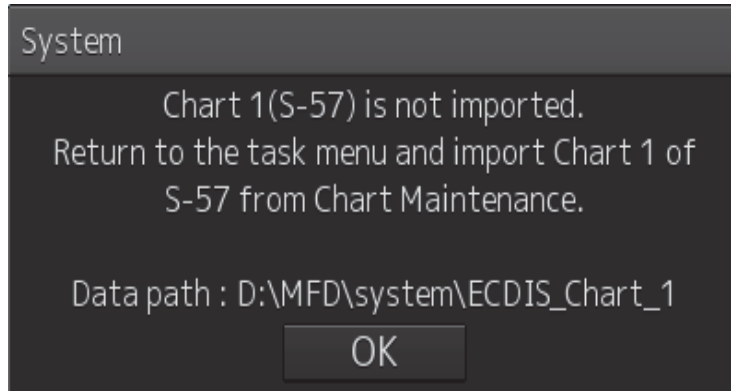
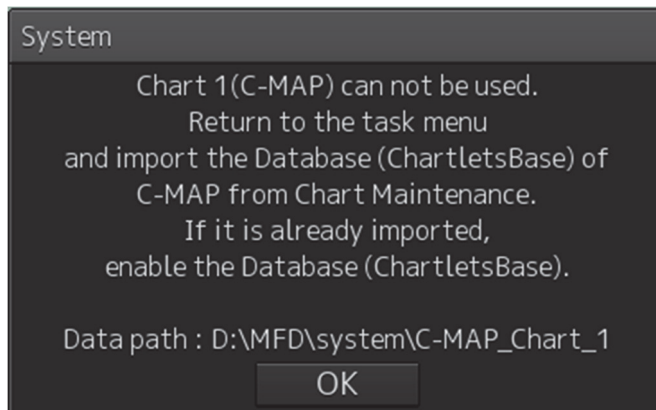
【S-57】**【C-MAP】**

11.14 Displaying differences at chart update

11.14.1 Displaying differences at S-57 chart update

When the S-57 chart is updated, only the latest object of the last Update No. is displayed in highlight mode.

Until the update is approved, the target object is displayed with a highlight marker.

When the update is approved, the highlighted display is cancelled.

The following table shows the drawing patterns of pre-approval and post-approval for each update content.

| Update content | Pre-approval drawing pattern | Post-approval drawing pattern |
|----------------|--|--|
| Addition | <ul style="list-style-type: none"> • When highlighted display of update is set to ON, an addition marker is displayed for the object to be added. • When highlighted display of update is set to OFF, only the object to be added is drawn. | Only the added object is drawn. |
| Deletion | <ul style="list-style-type: none"> • When highlighted display of update is set to ON, a deletion marker is displayed for the object prior to deletion. • When highlighted display of update is set to OFF, the target object is not drawn. | Deleted objects are not drawn. |
| Change | <ul style="list-style-type: none"> • When highlighted display of update is set to ON, a deletion marker is displayed for the pre-update object and an addition marker is displayed for the post-update object. • When highlighted display of update is set to OFF, only the post-update object is drawn. | Only the object after the change is drawn. |

Addition marker

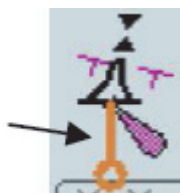

Deletion marker



11.14.2 Displaying differences at C-MAP chart update

When the C-MAP chart is updated, only the updated object of the last Update No. is displayed in highlight mode.

Since update approval operation is not available for the C-MAP chart, the update object of the last Update No. is displayed in the usual color immediately after the update.

However, when the [Check Applied C-MAP Updates] dialog is displayed, a highlighted display mark is displayed overlaying the updated object only for the cell that is selected on the screen.

The following table shows the drawing patterns at the usual state and the drawing patterns of the chart that is selected in the [Check Applied C-MAP Updates] dialog for each update content.

| Update content | Drawing patterns at usual state | Drawing patterns of the chart that is selected in [Check Applied C-MAP Updates] dialog |
|----------------|-----------------------------------|--|
| Addition | Only the added object is drawn. | The added object is drawn and highlighted display is overlaid on the object. |
| Deletion | The deleted object is not drawn. | The deleted object is not drawn and only highlighted display is drawn at the position of the object. |
| Change | Only the changed object is drawn. | The changed object is drawn and highlighted display is drawn over the object. |

11.15 Chart pick report

For the S-57 chart, when an object is clicked on, the pick cursor is displayed on the clicked position and the [Pick Report] dialog is displayed.

Memo

The pick cursor is a square frame that is displayed at the spot where the chart information is read and the information on the chart object that exists in the frame is displayed in the [Pick Report] dialog.

When the object is a symbol or a spot depth, the object itself is not displayed in highlight mode.

For a C-MAP chart, a pick cursor is not displayed.

11.16 Maintaining a Chart

Use the Chart Maintenance menu for management of chart data.

- 1 Click on the [Menu] button on the left toolbar.**
The menu is displayed.
- 2 Change over to the second page using the page switching button, and click the [Chart Maintenance] button.**

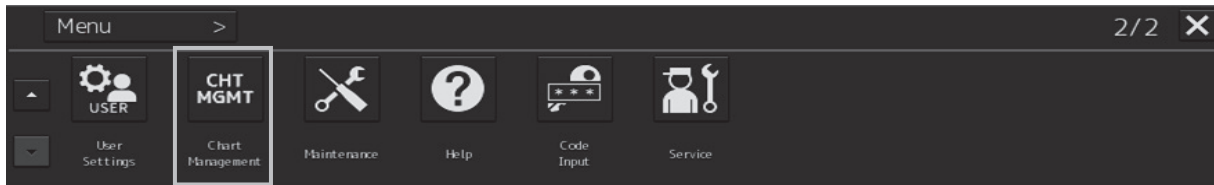

The [Chart Maintenance] dialog box appears.

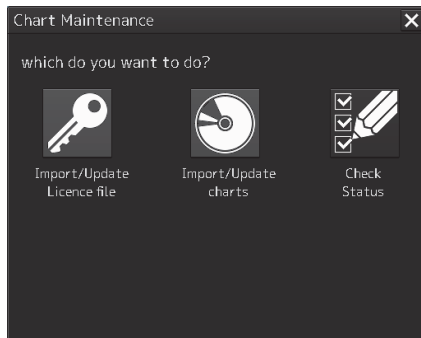

Three icons are assigned in the [Chart Maintenance] dialog box. Only the Check Status icon can be clicked.

Click on the Check Status icon when checking the status of the chart.

Memo

Operate "Import/Update Licence file" and "Import/Update charts" dialogs by clicking from the [Chart Maintenance] dialog box started in the task menu.

| Icon | Operation |
|----------------------------|---|
| Import/Update Licence file | Imports/updates the Licence file for importing a chart. |
| Import/Update charts | Imports/updates chart data. |
| Check Status | Checks chart status. |

For the operation of the Chart Maintenance menu, refer to a separate manual, "Additional Instruction Manual for Introducing Chart".

Section 12 Creating a User Chart/ Updating a Chart Manually

This section describes the procedures for creating a user chart and updating a chart manually.

User chart

A user specific map can be created by drawing various objects (symbol, line, area, and text) that are not displayed on the existing chart. The created user chart can also be updated by editing.

A user chart can be displayed by overlapping on a chart. A user chart can be created by merging two user charts.

The following diagrams show how to use user maps.

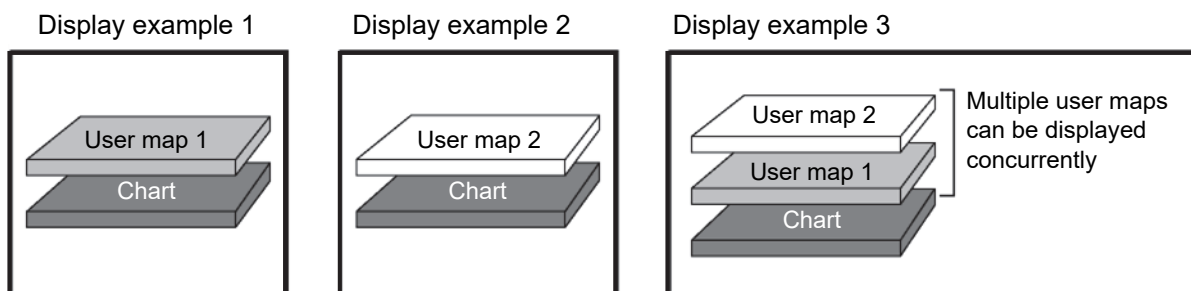

Example: User charts 1 and 2 are merged and displayed on a chart by overlaying.

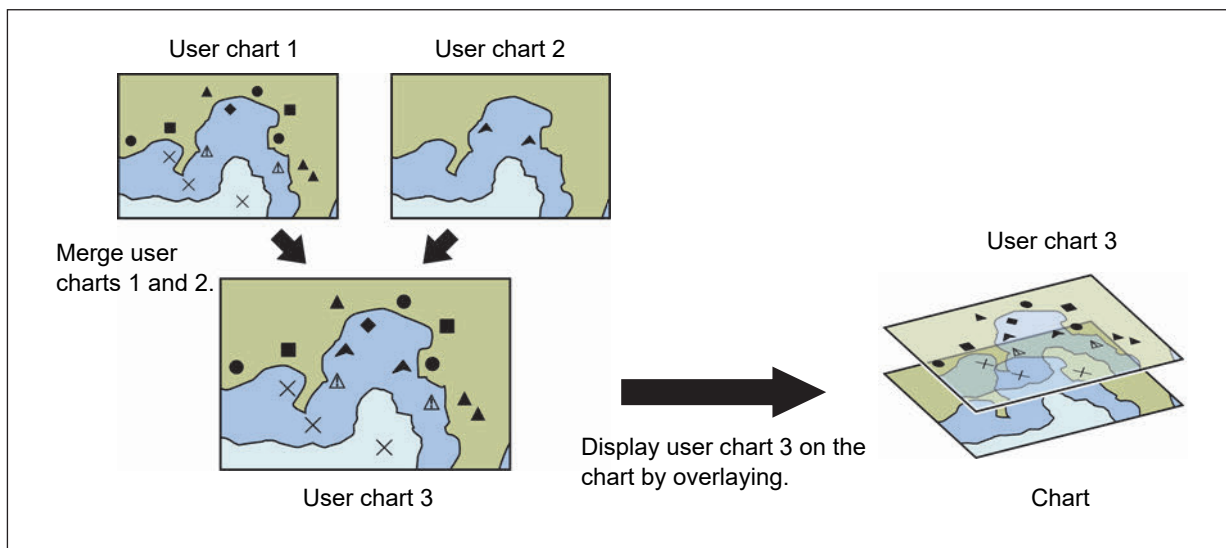

Manual Update

A chart can be updated manually by creating objects (symbols, lines, areas, and texts) on the specifying chart.

In the manually updated chart, objects are linked to the chart itself, unlike user charts. Therefore, although the manually updated objects can be hidden, they cannot be deleted easily.

For the details of hiding objects, refer to "12.4.1 Deleting or hiding an object (ARCS/C-MAP)" and "12.9.1 Deleting and hiding an object (S-57/S-63)".

12.1 Creating/Editing a User Map

Use the following procedure to create/edit a user map.

1 **Displaying the "User Chart " menu.**
Reference: "12.1.1 Display the "User Chart " menu".



2 **Displaying the "File Operation" submenu.**
Reference: "12.1.2 Display the File Operation submenu".



3 **Registering a new user chart file.**
Reference: "12.1.3 Creating a new user chart ".

3 **Invoking an existing user chart file.**
Reference: "12.1.4 Editing the existing user chart ".



4 **Creating/editing a user map by using map creation tools.**
Reference: "12.2 Using Map Creation Tools (User Chart Creation/Editing)".



| | |
|---|---|
| Creating an object Reference: "12.5 Creating an Object". | Moving an object Reference: "12.2.10 Moving an object". |
| Deleting an object Reference: "12.6 Collective Deletion of Objects [Delete by Type/Color]". | Managing/editing an object Reference: "12.7 Managing/Editing Objects [Mark Line/List]". |

12.1.1 Display the "User Chart " menu

When creating/editing a user chart, use the "User Chart " menu.

- 1 Click on the [Menu] button on the left toolbar.**
The menu is displayed.
- 2 Click on the [User Chart] button on the menu.**
The submenu is displayed.

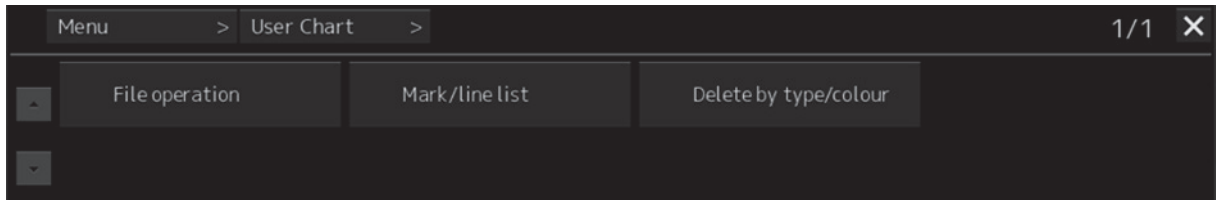

The User Chart menu comprises the following submenus.

| Submenu | Function |
|-----------------------|--|
| File Operation | <ul style="list-style-type: none">• Managing user chart files (new creation, loading, copying, deletion, import/export, geodetic conversion)• Displaying/editing a user chart• Merging user chart files Refer to "12.1.6 Operating a user chart file". |
| Delete by Type/Colour | Deleting objects collectively Refer to "12.6 Collective Deletion of Objects [Delete by Type/Color]". |
| Mark/Line List | Managing/editing objects Refer to "12.7 Managing/Editing Objects [Mark Line/List]". |

12.1.2 Display the File Operation submenu

- 1 Click on the [Menu] button on the left toolbar.
The menu is displayed.
- 2 Click on the [User Chart] button on the menu.
- 3 Click on the [File Operation] button on the submenu.
The [File Operation] operation dialog box appears.

12.1.2.1 [File Operation] dialog box

Manage the file at user chart creation and display and edit the user chart on the [File Operation] dialog box.

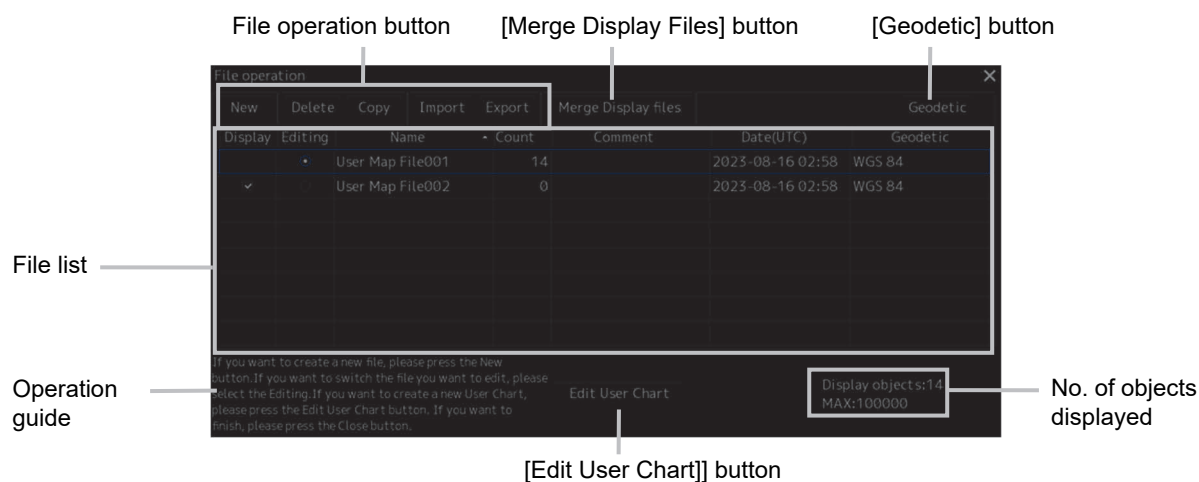

The user chart files that are currently saved are displayed in the file list.

The number of objects that are displayed is indicated at the bottom right corner of the dialog.

File list

Up to 500 user chart files (.uchm) can be registered in a file list. The following information is displayed for the user chart files that are currently saved.

| Item | Information |
|------------|--|
| [Name] | Indicates the name of the user chart file (up to 64 characters). The name can be changed by clicking on the name in the list. |
| [Count] | Indicates the total number of objects that are registered in the user chart file. |
| [Comment] | Indicates the comment on the user chart file (up to 64 characters). The comment can be changed by clicking on the comment in the list. |
| [Date] | Last update date of the user chart file |
| [Geodetic] | Displays the geodetic datum of the user chart file. To change the geodetic datum, refer to "12.1.6.6 Performing geodetic datum conversion". |
| [Display] | The [Display] check box is checked for the user chart file that is displayed. For the method of using the [Display] check box, refer to "12.1.5 Displaying a user chart". |
| [Editing] | The [Editing] button is set to ON for the user chart file that is being created or edited. For the method of using the [Editing] button, refer to "12.1.4 Editing the existing user chart". |

File operation buttons

| Button name | Function |
|-------------|---|
| [New] | Creates a new user chart file. For the details, refer to "12.1.3 Creating a new user chart". |
| [Delete] | Deletes a user chart file. For the details, refer to "12.1.6.1 Deleting a user chart file". |
| [Copy] | Copies a user chart file For the details, refer to "12.1.6.2 Copying a user chart file". |
| [Import] | Imports a user chart file from an external medium. For the details, refer to "12.1.6.3 Importing a user chart file". |
| [Export] | Exports the user chart that was created to an external medium. For the details, refer to "12.1.6.4 Exporting a user chart file". |

[Merge Display Files] button

This button merges the selected user chart files.

For the details, refer to "12.1.6.5 Merging multiple user chart files".

[Geodetic] button

This button selects the geodetic datum of the user chart file.

For the details, refer to "12.1.6 Performing geodetic datum conversion".

[Edit User Chart] button

This button edits the existing user chart file.

For the details, refer to "12.1.4 Editing the existing user chart".

12.1.3 Creating a new user chart

- 1** Click on the [Menu] button on the left toolbar.
The menu is displayed.
- 2** Click on the [User Chart] button on the menu.
- 3** Click on the [File Operation] button on the submenu.
The [File Operation] operation dialog box appears.

[New] button

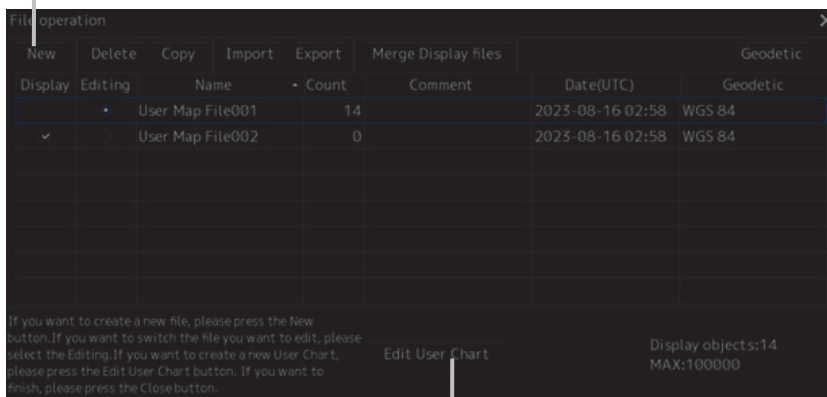

[Edit User Chart] button

- 4** Click on the [New] button.
The new user chart file is registered in the file list.
The file name can be changed by clicking on the file name that is displayed in the [Name] column in the file list.
- 5** Click on the [Edit User Chart] button in the [File Operation] dialog box.
The map creation tool is displayed.
Create or edit the user chart by using the map creation tool. (Refer to "12.2 Using Map Creation Tools (User Chart Creation/Editing)".)

12.1.4 Editing the existing user chart

- 1 Click on the [Menu] button on the left toolbar.
The menu is displayed.
- 2 Click on the [User Chart] button on the menu.
- 3 Click on the [File Operation] button on the submenu.
The [File Operation] operation dialog box appears.

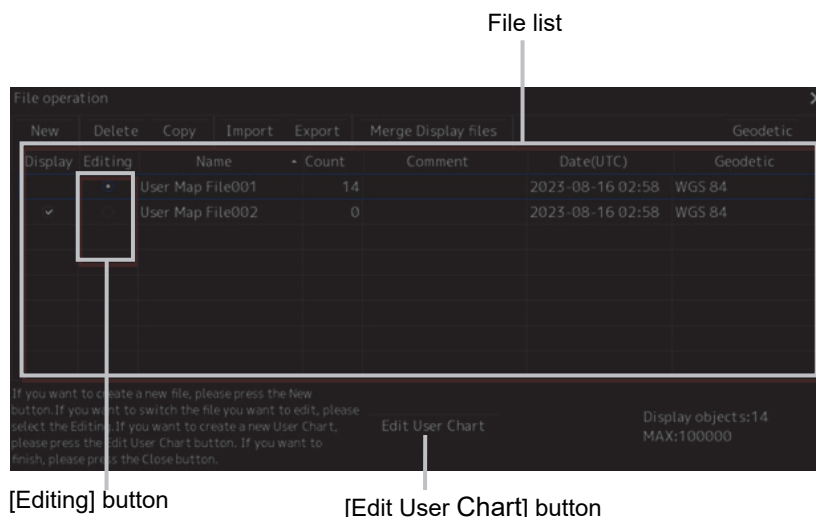

- 4 Click on the [Editing] button of the user chart file to be edited in the file list on the [File Operation] dialog.
The user chart file to be edited is displayed.
- 5 Click on the [Edit User Chart] button on the [File Operation] dialog box.
The map creation tools (drawing toolbar and the user chart information bar) are displayed and the cursor changes from the cross-hair cursor to the mark cursor.
Edit the user chart by using the map creation tools. (Refer to "12.2 Using Map Creation Tools (User Chart Creation/Editing)".)

12.1.4.1 Editing the user chart that is currently displayed

- 1 Display a user chart. (Refer to "12.1.5 Displaying a user chart".)
- 2 Click on the Write tool button on the left toolbar.
Map creation tools (drawing toolbar and user chart information bar) are displayed and the cursor changes to the mark cursor from the cross-hairs cursor.
- 3 Edit the user chart by using the map creation tools. (Refer to "12.2 Using Map Creation Tools (User Chart Creation/Editing)".)

- 4 To edit another user chart, click on the [File Operation] dialog display button on the user chart information bar. (Refer to "12.2 Using Map Creation Tools (User Chart Creation/Editing)".)

The [File Operation] dialog box appears.

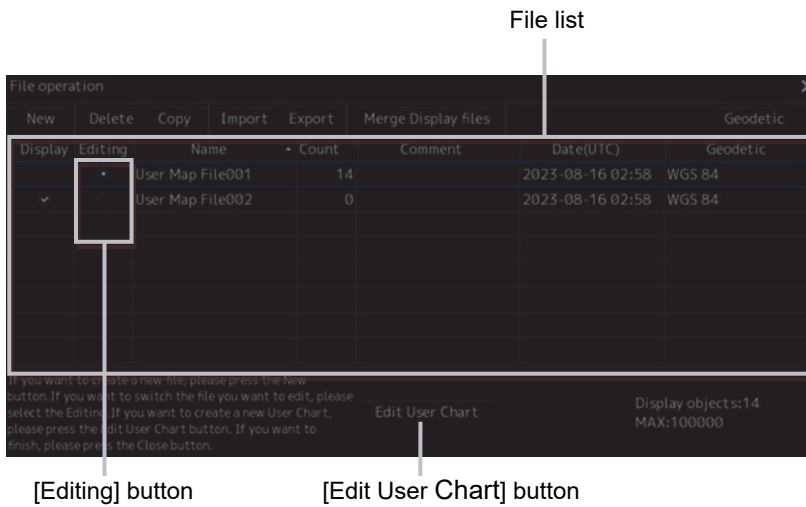

- 5 Click on the [Editing] button of the user chart file to be edited in the file list on the [File Operation] dialog box.

The selected user chart is displayed.

12.1.5 Displaying a user chart

- 1 Click on the [Menu] button on the left toolbar.
The menu is displayed.
- 2 Click on the [User Chart] button on the menu.
- 3 Click on the [File Operation] button on the submenu.
The [File Operation] dialog box appears.

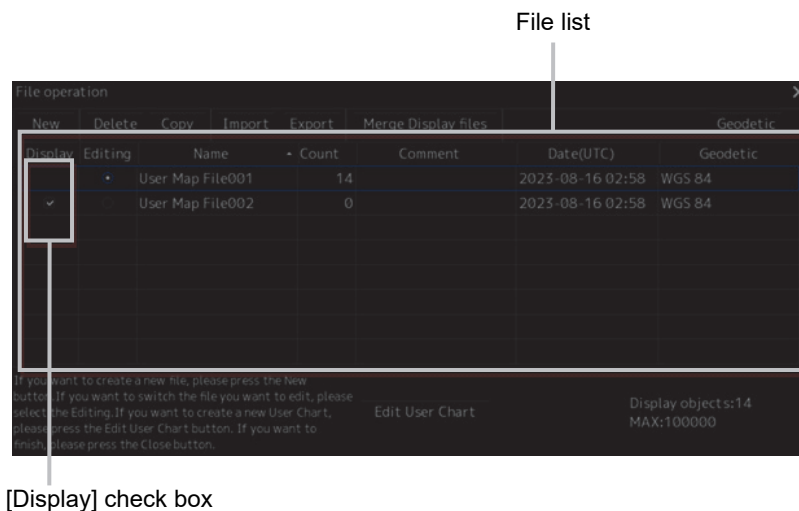

-
-
- 4 Select the [Display] check box of the user chart file to be displayed in the file list on the [File Operation] dialog box.**

The selected user chart is displayed.

12.1.6 Operating a user chart file

Manage the file at user chart creation, merge user charts, or select a geodetic datum on the [File Operation] dialog box.

12.1.6.1 Deleting a user chart file

- 1 Click on the user chart file to be deleted in the file list.**

The user chart file is selected.

- 2 Click on the [Delete] button.**

The selected user chart file is deleted.

12.1.6.2 Copying a user chart file

- 1 Click on the file to be copied in the file list.**

The user chart file is selected.

- 2 Click on the [Copy] button.**

The selected user chart file is copied.

The copied file is named under "Copy of (copy source file name)".

Note

If the file name exceeds 64 characters including "Copy of", the file cannot be copied.

12.1.6.3 Importing a user chart file

- 1 Click on the [Import] button.
A file selection window is displayed.
- 2 Select and import a user chart file that is saved in the external medium on the file selection window.

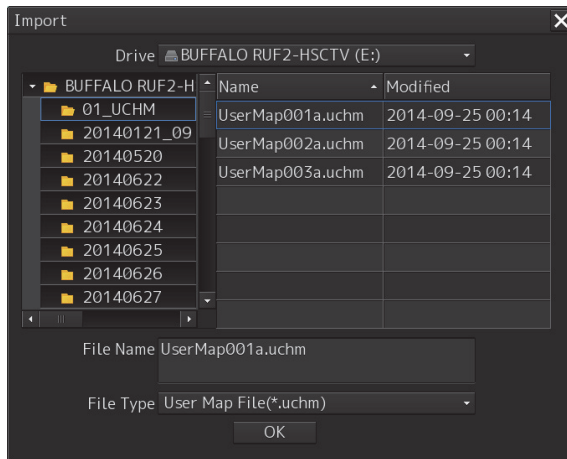

Note

When sufficient free storage space is not available in the import destination, a message dialog box is displayed.

Change the import destination or import a file after securing sufficient free space.

12.1.6.4 Exporting a user chart file

- 1 Click on the file to be exported from the file list.
A file selection window is displayed.
- 2 Click on the [Export] button.
A file selection window is displayed.
- 3 Specify an export destination and export the selected file.

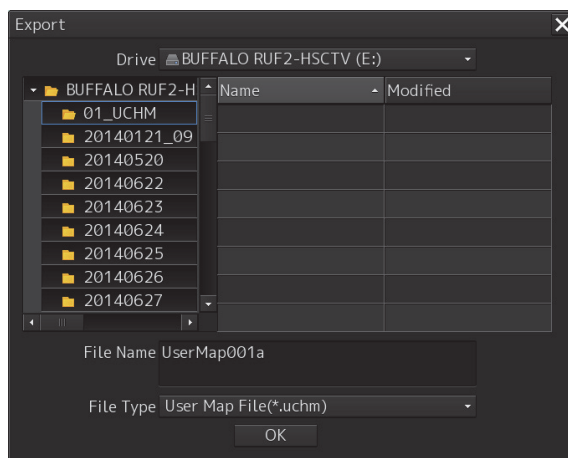

When the export destination contains a file of the same name, a message dialog box is displayed, prompting the verification of whether the existing file is to be overwritten.

When exporting the file by overwriting the existing one, click on the [OK] button.

Note

When sufficient free storage space is not available in the export destination, a message dialog box is displayed.

Change the export destination or import a file after securing sufficient free space.

12.1.6.5 Merging multiple user chart files

- 1 Select the [Display] check boxes of the files to be merged in the file list.**

The user chart files to be merged are displayed.

- 2 Click on the [Merge Display Files] button.**

A user chart file is created by merging the user maps that are being displayed. The user chart file is named under "Merged User Chart Filexxx" (xxx: serial number starting from 001).

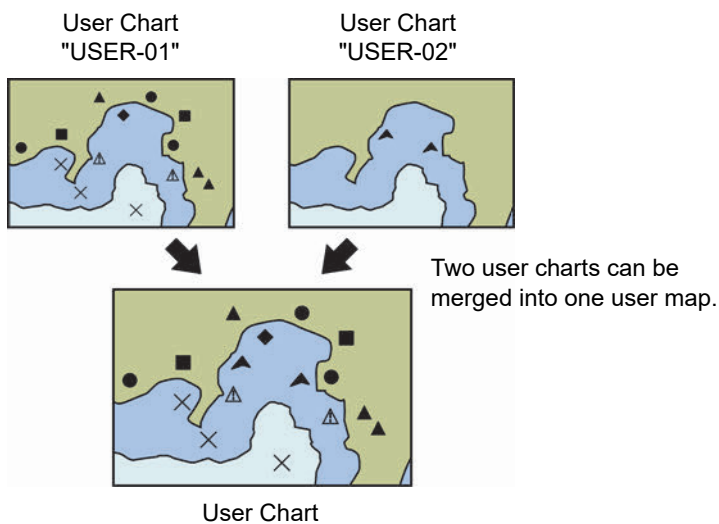

12.1.6.6 Performing geodetic datum conversion

It is possible to use the preset datum or convert the datum by entering an offset value.

- 1 Click on the user chart file whose geodetic datum is to be converted on the file list.**
The user chart file is selected.
- 2 Click on the [Geodetic] button.**
The [Geodetic Conversion] dialog box appears.

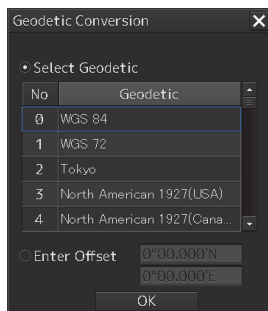

- 3 To use the preset geodetic datum, click on the [Select Geodetic] button and click on the geodetic datum on the list.**
When entering an offset value, click on the [Enter Offset] button and enter a numeric value.

Note

When [No Use] is selected on the [Select Geodetic] list, geodetic datum conversion is not performed.

- 4 Click on the [OK] button.**
Geodetic datum conversion is executed based on the setting in Step 3.

12.2 Using Map Creation Tools (User Chart Creation/Editing)

Use the map creation tools to create/edit a user chart or update a chart manually.

The following tools can be used for user chart creation.

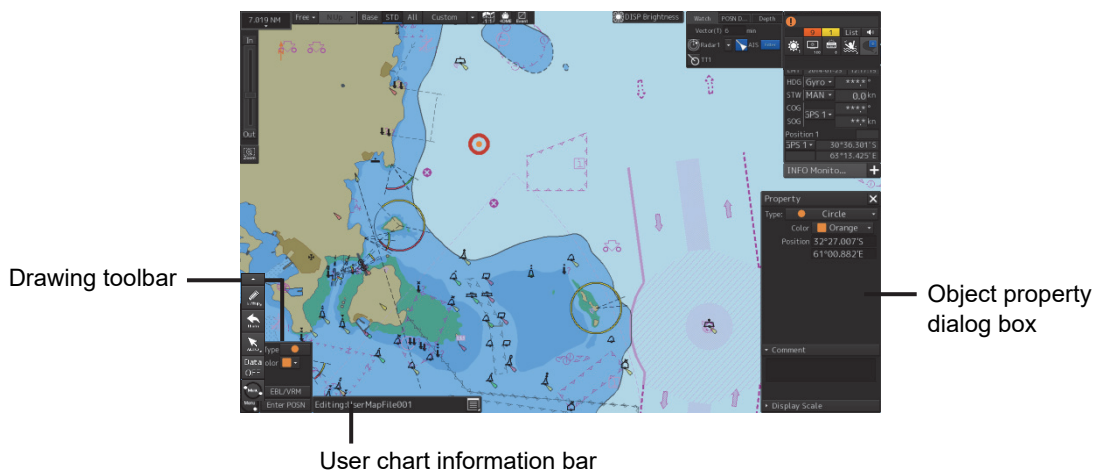

Note

The map creation tool configuration and functions vary depending on whether a chart is edited manually or a user chart is created.

For the details, refer to "12.4 How to Use the Map Creation Tools (At Manual Update of ARCS)"

12.2.1 User chart information bar

The user chart information bar is located at the bottom right corner of the screen and displays the user chart name that is currently being created/edited.

The [File Operation] dialog box can be displayed by clicking on the [File Operation] dialog box display button.



12.2.1.1 Displaying a user chart information bar

- 1 Select [User Chart] - [File Operation] on the menu.
- 2 Click on the [Edit User Chart] button on the [File Operation] dialog box that is displayed.

The user chart information bar can also be displayed by clicking on the write tool button on the left toolbar.

12.2.2 Drawing toolbar

Display a drawing toolbar by clicking on the drawing tool button on the left toolbar.

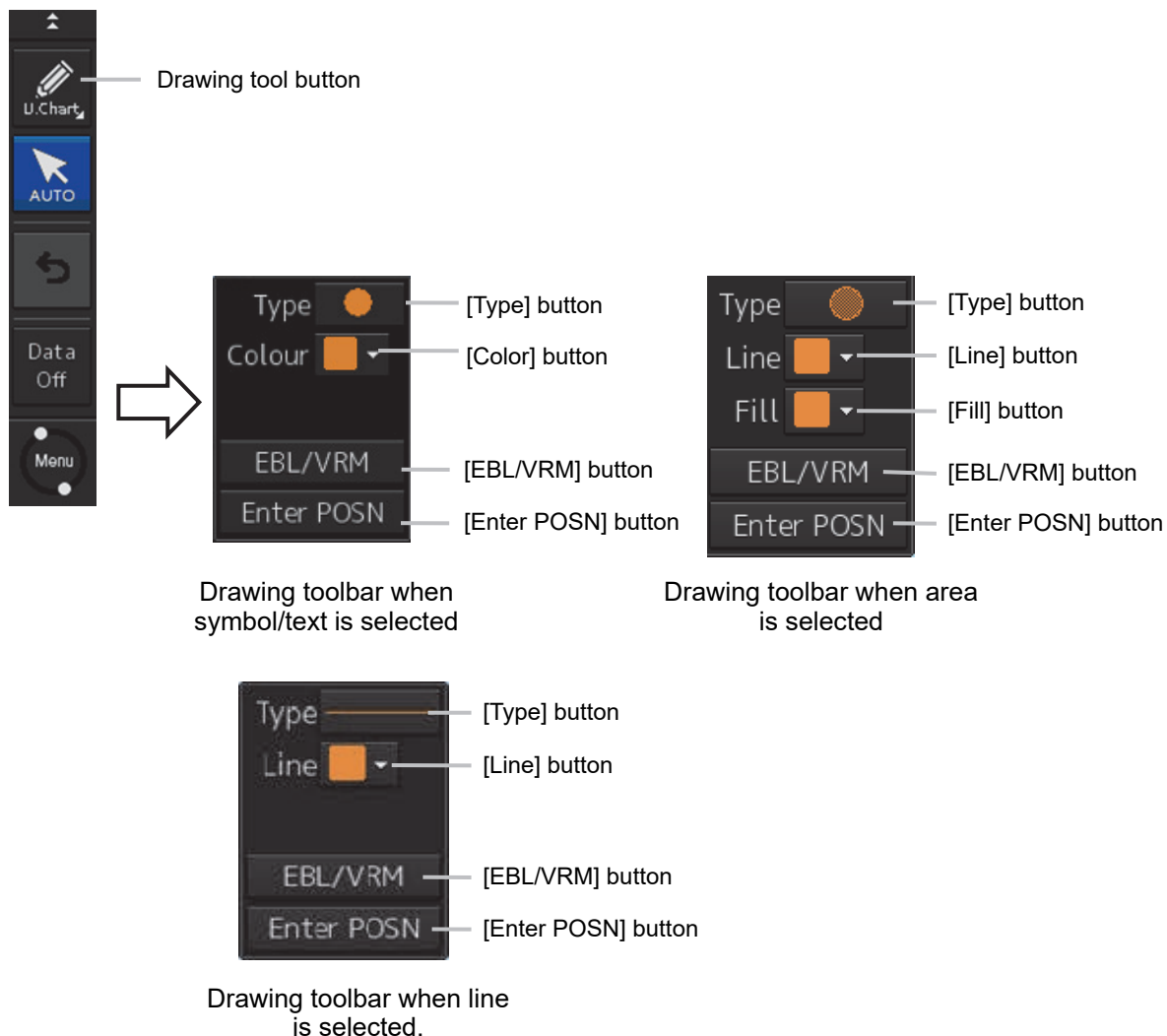

When creating a user chart, the writing tool button is displayed in blue indicating selection.

Note

At user chart creation, the azimuth mode is fixed to the [N UP] mode.

The drawing toolbar comprises the following tool buttons. The buttons that are assigned vary according to the object type (Symbol/Line/Area/Text) that is currently selected.

| Tool button | Function |
|---|---|
| [Type] button | Displays an icon list. (Refer to "12.2.3 Selecting an object type".) |
| [Color] button (Symbol/text selection) | Select the color of the symbol/text. (Refer to "12.2.4 Selecting a color of an object".) |
| [Line] button | Enables selection of a color of the line that forms the object. (Refer to "12.2.4 Selecting a color of an object".) |
| [Fill] button (at area selection only) | Enables selection of a color of the area that forms the object. (Refer to "12.2.4 Selecting a color of an object".) |
| [EBL/VRM] button | Switches the cursor mode of the user chart creation function to the EBL/VRM mode. (Refer to "12.2.5 Creating an object in the EBL/VRM mode".) |
| [Enter POSN] ([Enter Position] dialog display) button | Displays the [Enter Position] dialog (Refer to "12.2.6 Creating an object by specifying latitude and longitude".) |

12.2.3 Selecting an object type

By displaying an icon list, the type of the Mariner's Mark/Line object or the user chart object ([Symbol], [Line], [Area], and [Text]) can be selected.

1 Click on the [Type] button on the drawing toolbar.

An icon list is displayed.

2 Select a type of the object by clicking on the icon in the icon list.

The icon list can be switched to thumbnail display or list display by clicking on the thumbnail/list display switching button.

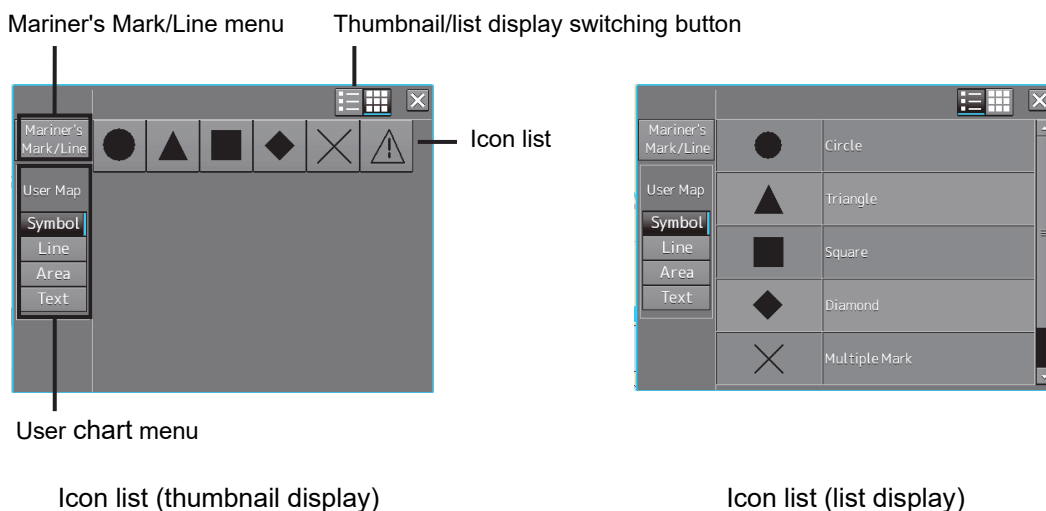

For the icons that can be selected from the icon list, refer to "Appendix B.5 Icon Button List for User Chart".

12.2.3.1 Using a user chart object

Select a type of the object (symbol/line/area/text) to be displayed in the icon list by clicking on a user chart menu button.

The following objects are displayed.

| Button | Icons displayed |
|-----------------|--|
| [Symbol] button | Circle Triangle Square Diamond Multiple Mark Caution Symbol Warning symbol Alarm Symbol |
| [Line] button | Simple line(solid line) Simple line(dotted line) Simple line(dashed line) Circle(solid line) Circle(dotted line) Circle(dashed line) Ellipse(solid line) Ellipse(dotted line) Ellipse(dashed line) Arc(solid line) Arc(dotted line) Arc(dashed line) Caution Line Warning line Alarm Line Arrow(Start To End/Small) Arrow(Start To End/Medium) Arrow(Start To End/Large) Arrow(End To Start/Small) Arrow(End To Start/Medium) Arrow(End To Start/Large) Arrow(Both Direct/Small) Arrow(Both Direct/Medium) Arrow(Both Direct/Large) |
| [Area] button | Polygon(solid line) Polygon(dotted line) Polygon(dashed line) Circle(solid line) Circle(dotted line) Circle(dashed line) Ellipse(solid line) Ellipse(dotted line) Ellipse(dashed line) Fan(solid line) Fan(dotted line) Fan(dashed line) Caution area(solid line) |

| | |
|---------------|--|
| | Caution area(dotted line) Caution area(dashed line) Warning area(solid line) Warning area(dotted line) Warning area(dashed line) Alarm area(solid line) Alarm area(dotted line) Alarm area(dashed line) |
| [Text] button | Text |

12.2.4 Selecting a color of an object

1 When selecting a color of the symbol/text object on the drawing toolbar, click on the [Color] button.

To select a line color of an area object, click on the [Line] button.

To select a color for filling an area object, click on the [Fill] button.

2 Select and click on the required color on the list that is displayed. The following 10 colors are available.

- White/Black

(The color changes to White/Black under the following conditions.

RADAR screen: Always White

ECDIS screen: Day1/Day2: Black, Day3/Dusk/Night: White)

- Gray
- Amber
- Magenta
- Blue
- Cyan
- Green
- Yellow
- Orange
- Dark Red

12.2.5 Creating an object in the EBL/VRM mode

1 Click on the [EBL/VRM] button on the drawing toolbar.

The user chart creation function mode is switched from the cursor mode to the EBL/VRM mode.

When the mode is switched to the EBL/VRM mode, the cursor changes to the following state.



EBL/VRM base point cursor

The EBL/VRM mode is switched to cursor mode when the right mouse button is clicked on the chart or the [Enter POSN] button on the drawing toolbar is clicked on

12.2.6 Creating an object by specifying latitude and longitude

Using the [Enter Position] dialog box, it is possible to create an object at the specified latitude and longitude.

Displaying the [Enter Position] dialog box

- 1 Click on the [Enter POSN] button on the drawing toolbar.

Note

An object cannot be created with the cursor mode and EBL/VRM mode while this dialog box is displayed.

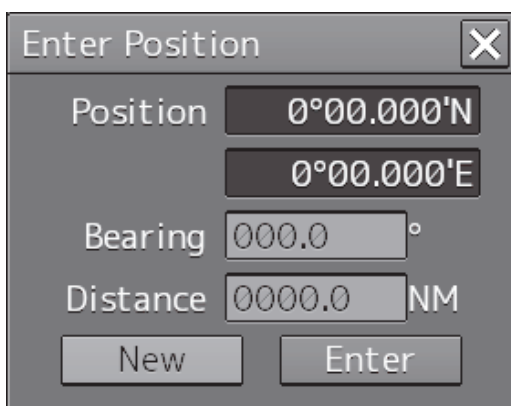

[Enter Position] dialog box

12.2.6.1 Creating an object of symbol/circle/ellipse/arc/arrow/text

Enter latitude and longitude values of the object in the [Position] box and click on the [Enter] button.

Memo

The maximum latitude input range of Position is 85 ° 00.000 (polar range restriction).

The [Bearing] box, [Distance] box, and the [New] button are disabled.

12.2.6.2 Creating an object of simple line/polygon/highlight

Use the following procedure to create an object with vertices such as a simple line, polygon, and highlight.

- 1 Enter latitude and longitude values of a vertex of the object in the [Position] box and click on the [Enter] button.**

The position of one of the vertices of the object is determined.

The [Bearing] box and the [Distance] box are enabled.

- 2 Enter latitude and longitude values of the next vertex in the [Position] box. Alternatively, in the [Bearing] box and the [Distance] box, enter the bearing and distance from the previous vertex that was determined.**

- 3 Click on the [Enter] button.**

- 4 Repeat Steps 2 and 3.**

A simple line can be determined by two or more vertices and a polygon/highlight can be determined by three or more vertices.

- 5 To create a next object continuously, click on the [New] button.**

12.2.7 Deleting an object

- 1 Click on the eraser tool button on the left toolbar.**

The cursor changes to the eraser cursor.



- 2 Place the cursor on the eraser cursor and click the mouse button.**

When the right button is clicked on any position with the eraser cursor, the cursor mode is reset to the cross-hairs cursor.

Objects of the same shape or color can be deleted collectively. For the details, refer to "12.6 Collective Deletion of Objects [Delete by Type/Color]".

When the left mouse button is clicked on the target object in eraser mode, an operation according to the object is performed.

12.2.8 Object property dialog box

An object property dialog box displays the properties of the object that is currently selected. Parameter settings of the object can be verified/changed.

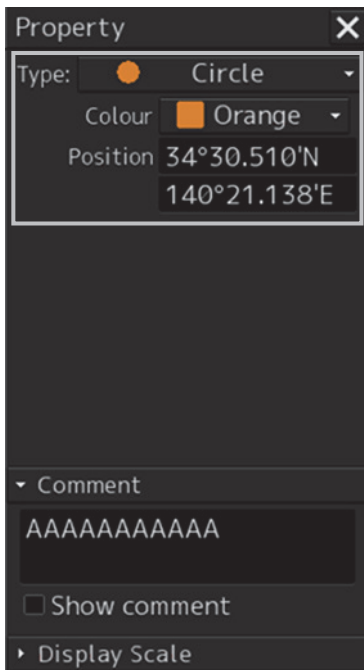

Parameter setting area

Object property dialog box
(Selecting Circle)

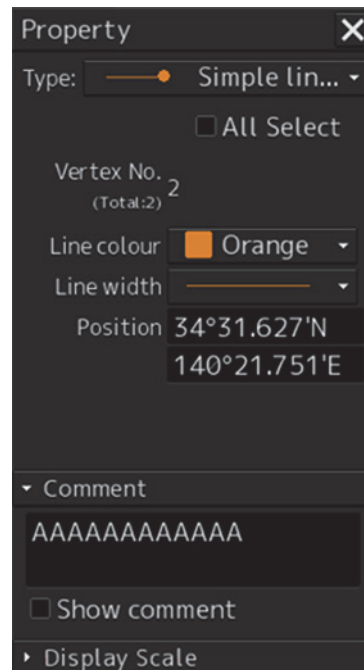

Object property dialog box
(Selecting Simple Line)

12.2.8.1 Selecting an object

- 1 Click on the object to be selected with the cross-hairs cursor.

The object is selected and the object property dialog box appears.



12.2.8.2 Setting a comment

In the object property dialog box, a comment for the object can be entered. When the [Show Comment] check box is selected, a comment can be displayed on the user chart.

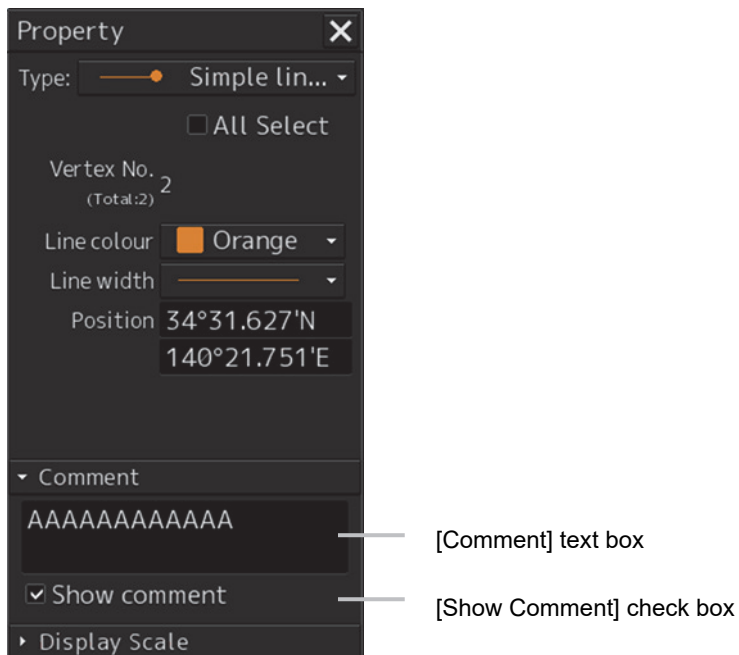

- 1** Enter a comment in the [Comment] box (up to 64 characters).
- 2** To display the comment that is input on the user chart, select the [Show Comment] check box.

12.2.9 Changing an object display scale range

An object display scale range (1:1 to 1:100,000,000) can be changed on the object property dialog box.

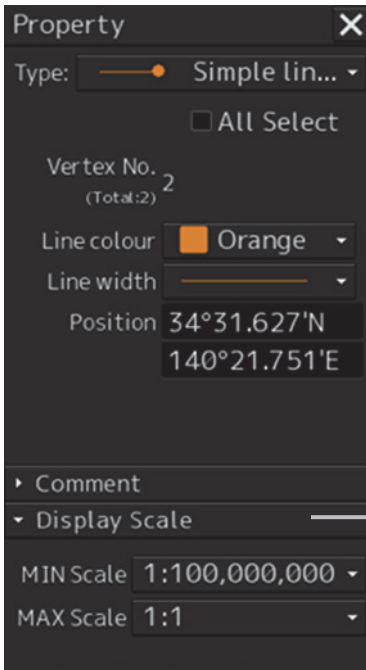

[Display Scale] setting section

- 1 Select a minimum scale on the [MIN scale] combo box.
- 2 Select a maximum scale on the [MAX scale] combo box.

12.2.10 Moving an object

To move an object, use the context menu that is displayed by clicking the right button on the object.

- 1 **When the object to be moved is in the selected state, unselect the object.**
To unselect the object, click on a section without display or another object.



- 2 **Click the right button on the object.**
The object is selected and the context menu is displayed.

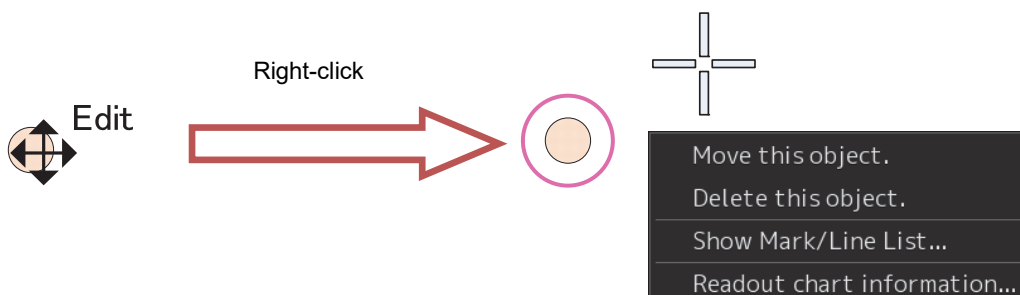

3 Click on [Move this object].

4 Click on the position to which the object is to be moved.

The selected object moves to the position on which the button was clicked.

12.3 Updating a Chart Manually (ARCS/C-MAP)

Use the following procedure to update a chart.

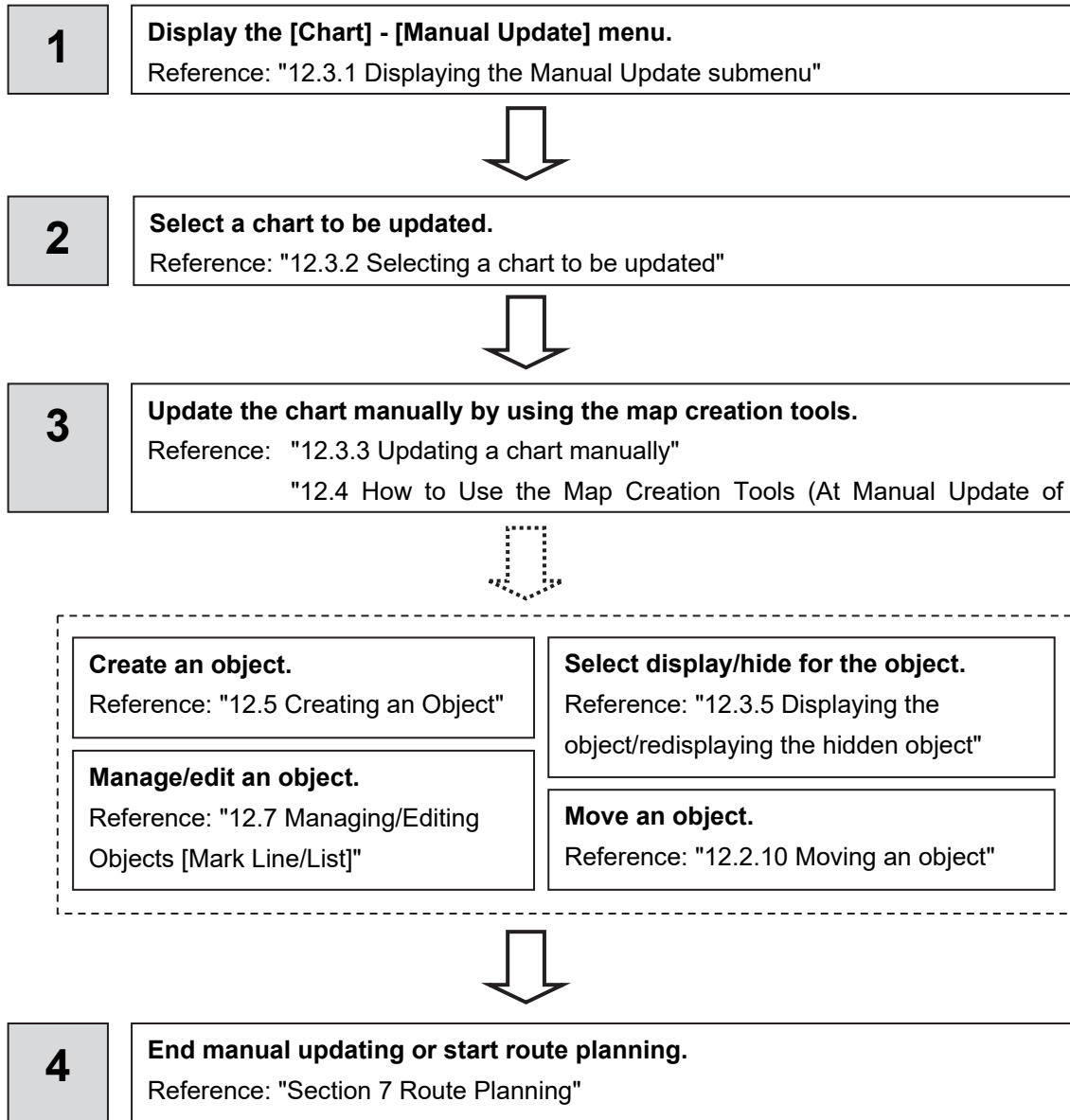

12.3.1 Displaying the Manual Update submenu

By selecting [Menu] - [Chart] - [Manual Update], the selected chart can be updated manually.

Restrictions

Multi-screen display is disabled at manual update of a chart. Even if multi-screen display is attempted prior to the commencement of manual update, the mode is switched to Single View if manual update is commenced.

Note

Since a dialog box requesting a Notice to Mariners issuing date is displayed when the updated chart is saved, enter the issuing date.

- 1 Click on the [Menu] button on the left toolbar.**
The menu is displayed.
- 2 Click on the [Chart] button on the menu.**
- 3 Click on the [Manual Update] button on the submenu.**
The "Manual Update" toolbar is displayed.

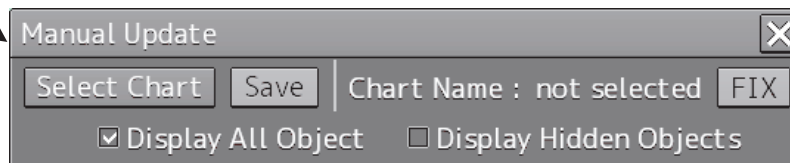
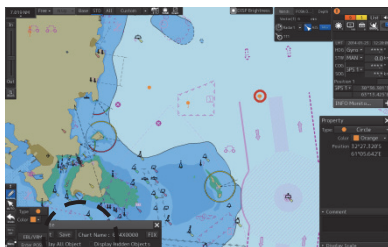

"Manual Update" toolbar

12.3.2 Selecting a chart to be updated

- 1 Click on the [Select Chart] button on the Manual Update toolbar.
The [Select Chart] dialog box appears.

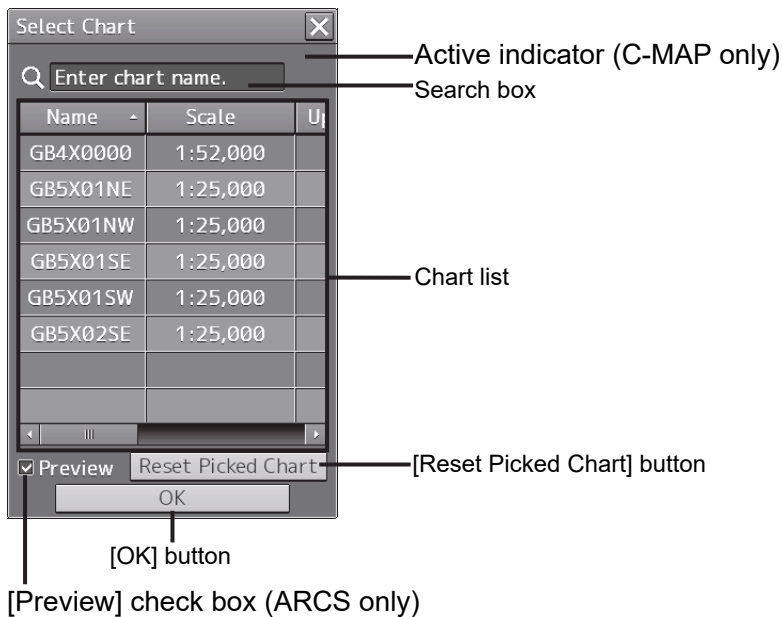

[Select Chart] dialog box

When the target of manual update is a C-MAP chart, an active indicator (🔴) may be displayed. While the active indicator is displayed, the chart list is not displayed. Only the moving of the [Select Chart] dialog and Close operations are available.

When a chart list is displayed, the active indicator is hidden.

- 2 Select a chart file to be updated manually on the [Select Chart] dialog box.

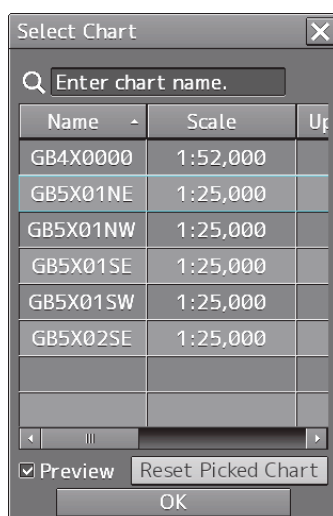

- 3 Click on the [OK] button in the [Select Chart] dialog box.
A chart is selected.

Memo

The information that is displayed in the chart list varies depending on the chart type.

The following information (columns of chart list) varies depending on the chart type.

○: Displayed
×: Not displayed

| Information (Columns of chart list) | Chart type | |
|-------------------------------------|-----------------|------|
| | C-MAP | ARCS |
| Service | × | ○ |
| Issue Date | ○ | × |
| Ed. Date | × | ○ |
| Expiry | × | ○ |
| Last Update | ○ ^{*1} | ○ |
| Accepted | ○ ^{*2} | × |

*1 Always the same value as the Issue Date is displayed.

*2 Always [YES] is displayed.

12.3.2.1 Displaying a chart list for the C-MAP chart

When a C-MAP chart is to be updated manually, the following charts are displayed in the chart list.

- Only the databases of C-MAP Ed.3 Database that are selected in the [View-Options] dialog that is displayed by selecting [View]-[Options]-[Chart Common] in the menu are displayed in the list.
- When no database is selected in the [View-Options] dialog that is displayed by selecting [View]-[Options]-[Chart Common] in the menu and a search condition is specified, all the C-MAP charts are displayed in the list.
- When a chart is clicked on, only the chart that is displayed in View is displayed in the list.

12.3.2.2 Searching the position that is clicked on with the cursor

- 1 Move the cursor to the position where manual update is to be performed and click the button.**

ARCS:

All the charts that are overlaid on the position that was clicked on are displayed in the chart list.

C-MAP:

The chart that is drawn at the position that is selected by clicking is displayed in the chart list.

Memo

To clear the search result, click on the [Reset picked chart] (chart selection reset) button on the [Select Chart] dialog box. For C-MAP, all the charts in the database are displayed in the chart list.

12.3.2.3 Searching a chart with the chart name

- 1 Enter a chart name in the search box on the [Select Chart] dialog box.
The applicable chart is displayed.

Memo

To clear the search result, clear the input in the search box.

12.3.2.4 Displaying the chart screen that is selected from the list (ARCS only)

When the target of manual update is an ARCS chart, the chart file to be updated can be displayed on the screen for verification before starting the update.

When the [Preview] check box is checked, the chart that is selected in the list is displayed at the center of the screen.

When the check box is unchecked, the display is cleared.

12.3.2.5 Absence/expiration of the C-MAP chart license

When C-MAP is targeted for manual update and the C-MAP that is selected from the chart list does not have any license or the license has expired, the chart is not selected and the following dialog is displayed.

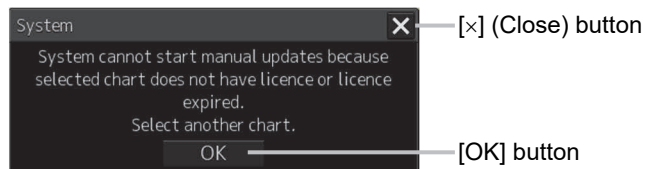

Close the dialog by clicking on the [OK] button or the [X] button and select another chart.

12.3.3 Updating a chart manually

- 1** By using map creation tools, create/edit an object on a chart. (Refer to "12.2 Using Map Creation Tools (User Chart Creation/Editing)".)
- 2** Delete an object or change the properties as required. (Refer to "12.6 Collective Deletion of Objects [Delete by Type/Color]").)

- 3** Click on the [Save] button.

The [Notice to Mariners] dialog box appears.

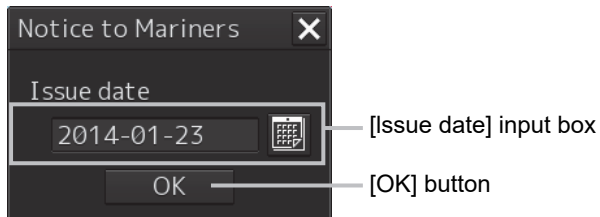

- 4** Enter a notice to mariners issuing date in the [Issue date] input box on [Notice to Mariners] dialog by using a software keyboard.

- 5** Click on the [OK] button in the [Notice to Mariners] dialog box.

The manually updated object is saved in the chart.

12.3.4 Displaying selected chart only

Memo

For the C-MAP chart or the ARCS chart, the [FIX] button cannot be set to ON.

12.3.5 Displaying the object/redisplaying the hidden object

To display all the objects that were created by chart manual update, select the [Display All Object] check box on the Manual Update toolbar.

To redisplay the hidden objects, select the [Display Hidden Objects] check box on the Manual Update toolbar.

12.4 How to Use the Map Creation Tools (At Manual Update of ARCS/C-MAP)

At chart manual update also, use the same map creation tools in the same way as that of user chart creation. (Refer to "12.2 Using Map Creation Tools (User Chart Creation/Editing)".) However, there are the following differences in the map creation tools

- The user chart information bar is not displayed.
- The object that is saved cannot be deleted by the eraser tool (can be hidden).
- A Mariner's Mark/Line drawing object cannot be selected with the drawing tool.
- More icon types can be selected in the drawing tool.

When the chart is updated manually, "Update" is displayed on the Write tool button.

Note

At chart manual update, the bearing reference mode is fixed to [N UP] mode.

12.4.1 Deleting or hiding an object

1 Click on the eraser tool button.

The cursor changes to the eraser cursor.



2 Place the eraser cursor on the object and click the button.

At manual update, only pre-saved objects can be deleted by the eraser tool.

If the saved object is clicked on with the eraser tool, the object is hidden. All the property screens of the object that has been set to hide are displayed as disable and cannot be edited.

The object that is created and saved by manual update can be redisplayed unless deleted even if it is hidden.

If the chart that uses the hidden object is updated, the expiration date of the object is set (90 days from the date on which the object is c).

The object will be deleted after the expiration date.

Also, the object property dialog box setting can be changed by using the Mark/Line List submenu.

For the details, refer to "0".

12.4.2 Selecting an object type

- 1 Click on the [Type] button on the drawing toolbar.
An icon list dialog is displayed.
- 2 Select an object type by clicking on the icon on the icon list.
At manual update, the following icon list is displayed.

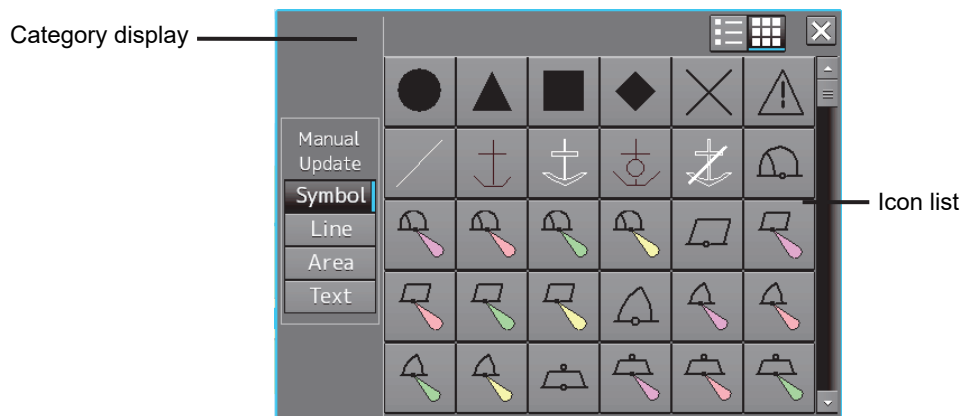

Icon list at manual update

The [Mariner's Mark/Line] button is not displayed on the icon list at manual update.

For the details of icons that can be selected from the icon list, refer to "Appendix B.6 Icon Button List for Manual Update".

12.5 Creating an Object (At Manual Update of ARCS/C-MAP)

This section describes the procedures for changing the parameters of the object after creating the object on the user chart or chart during manual update.

Note

After automatic sailing, the mark/line may be shifted depending on how the cursor is placed on the target at the input.

To prevent the shift, place the cursor on the front edge of the target.

- Input method that does not cause shift (place the cursor on the front edge of the target)

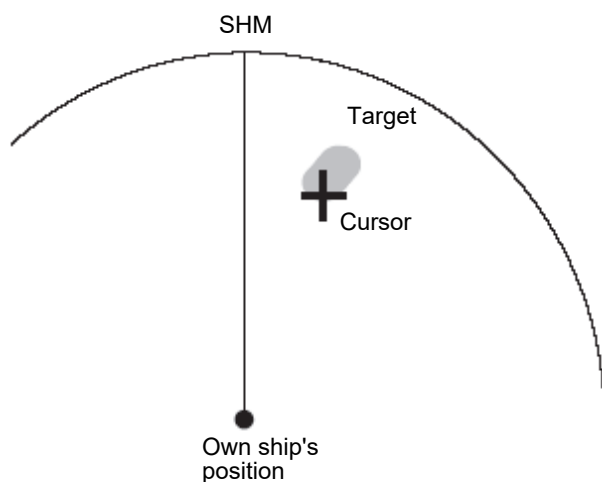

- Input method that causes shift (place the cursor on the center of the target)

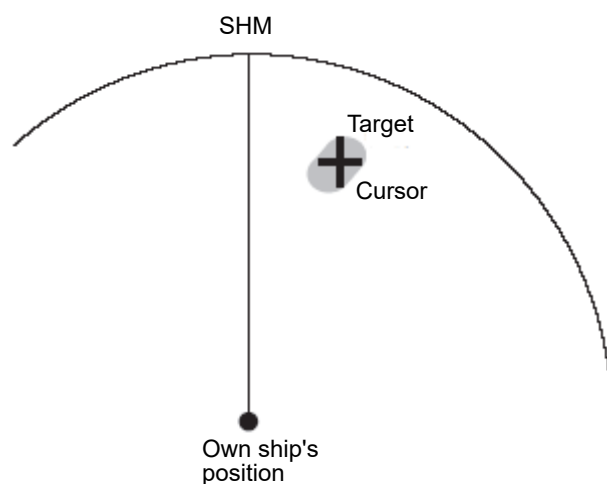

12.5.1 Creating a symbol object (Symbol)

A symbol or a Warning symbol can be created by specifying the creation position with the cursor.

- 1 Click on the [Type] button on the drawing toolbar.

An icon list is opened.

Select a symbol or an icon of the Alerts symbol. (Refer to "12.2.3 Selecting an object type".)

- 2 Click on the position on which the symbol is to be created with the cursor.



The symbol is displayed on the position on which the button is clicked and the parameters of the symbol that was created are displayed on the object property dialog box.

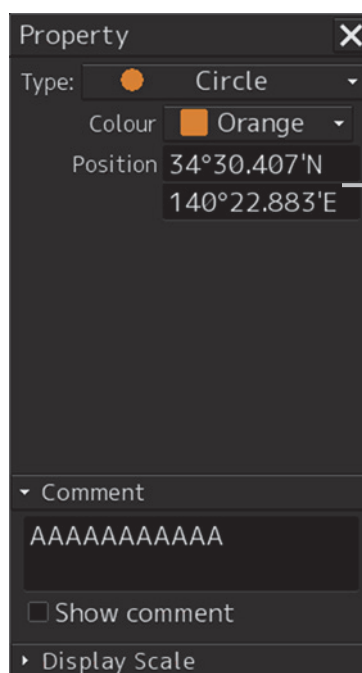
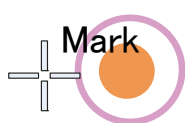

Latitude and longitude of the symbol creation position

- 3 Adjust the parameters on the object property dialog box.
- 4 To create an object on another position continuously, repeat Steps 2 and 3.

12.5.1.1 Creating an object by specifying the latitude and longitude

- 1 Click on the [Enter POSN] button on the drawing toolbar.

The [Enter Position] dialog box appears (Refer to "12.2.6 Creating an object by specifying latitude and longitude").

- 2 Enter the latitude and longitude of the position on which an object is to be created and click on the [Enter] button.**

An object is created on the specified latitude and longitude and the property information is reflected in the object property dialog box. (Refer to "12.2.8 Object property dialog box".)

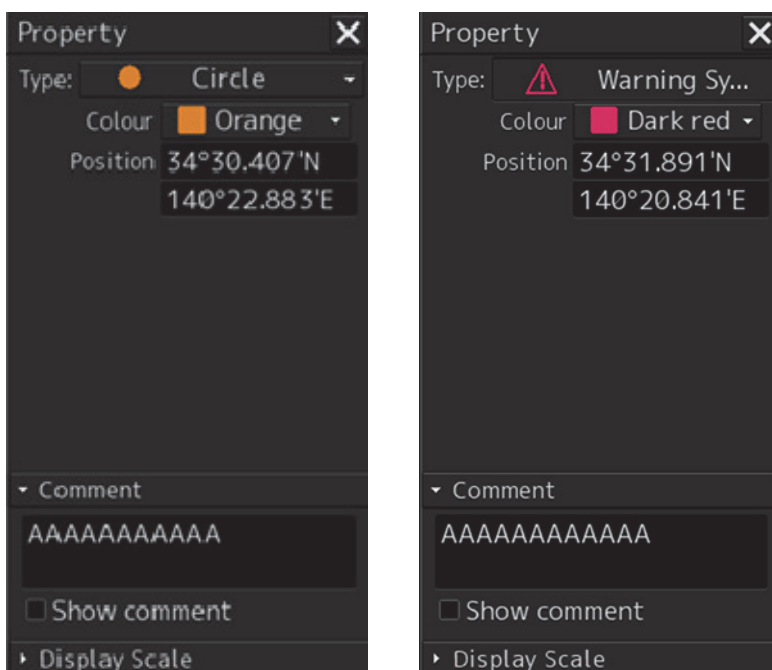

- 3 Adjust the parameters on the object property dialog box.**
- 4 To create an object on another position continuously, repeat Steps 2 and 3.**

At user chart creation, the symbol size can be changed by selecting [Option] - [User Chart] on the View menu.

For the details, refer to "14.2.4 Setting up the Display of User Chart".

12.5.1.2 Creating an object with EBL/VRM operation

- 1 Click on the [EBL/VRM] button on the drawing toolbar.**

The cursor changes to the EBL/VRM reference point cursor. (Refer to "12.2.5 Creating an object in the EBL/VRM mode".)
- 2 Click on the position of the reference point of the EBL/VRM marker.**

The EBL/VRM marker is displayed.
- 3 Place the EBL/VRM marker on the position on which the object is to be created and click the button.**

An object is created on the position on which the button was clicked and the property information is reflected in the object property dialog box. (Refer to "12.2.8 Object property dialog box".)
- 4 Adjust the parameters on the object property dialog box.**
- 5 To create an object on another position continuously, repeat Steps 2 to 4.**

12.5.2 Creating a simple line and a Alerts line (Line object)

A simple line and Alerts line are created by using one vertex as an object. Alerts line is a line object that is detected as the warning target (danger line) of own ship.

Note

The color of Alerts line cannot be changed.

1 Click on the [Type] button on the drawing toolbar.

An icon list is opened.

Select an icon of a simple line or Alerts line. (Refer to "12.2.3 Selecting an object type".)

2 Click on the starting point with the cursor.

A vertex is created and the property information of the vertex is displayed on the object property dialog box.

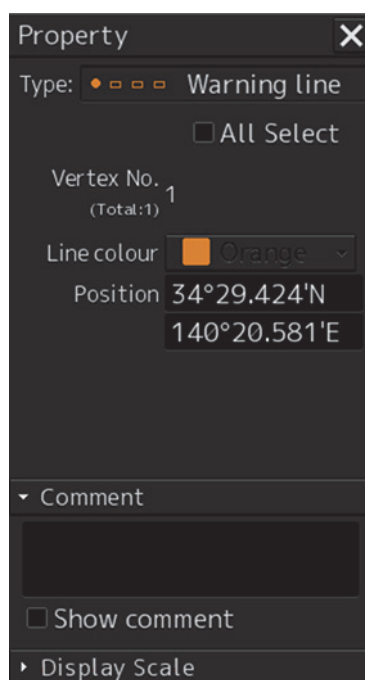
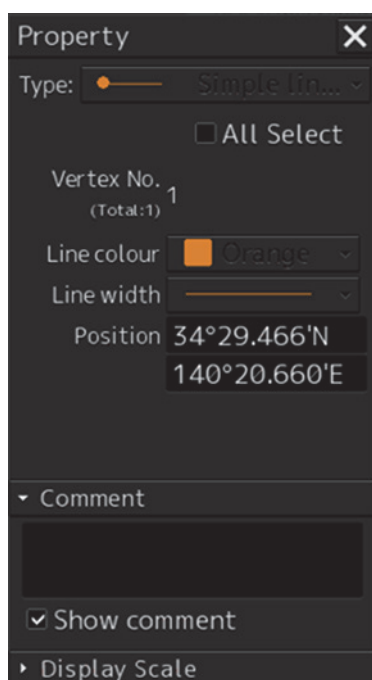

3 Move the cursor to the next vertex.

The latitude and longitude of the cursor are displayed near the cursor.



4 Click on the position on which the 2nd vertex is to be created.

A vertex is created and the parameters of the 2nd vertex are displayed on the object property dialog box.

Releasing the starting point selection state

Addition of 2nd point

Mark

The property screen is updated after the 2nd position is added.

Property

Type: Simple lin... [Type] becomes the medium point.

All Select

Vertex No. 2 (Total:2) The number of vertices becomes 2.

Line colour Orange Editing of the line color and width is enabled.

Line width

Position 34°32.181'N The coordinates of the 2nd point are entered.

140°20.344'E

Comment

Show comment

Display Scale

5 Determine the line by double-click on the button or click the right button.

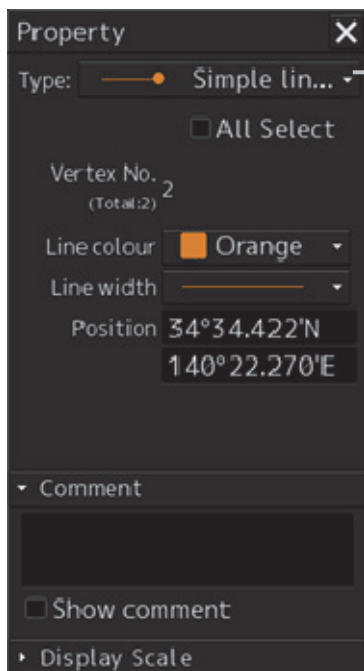
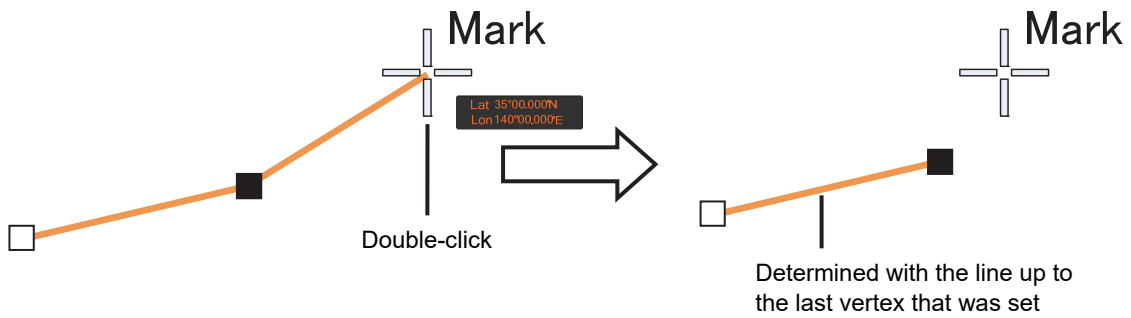

After determining of drawing, the last vertex changes to the end point.

6 Adjust the parameters on the object property dialog box.

7 To create an object on another position continuously, repeat Steps 2 to 6.

Memo

The property screen for the vertex that was created can be edited in AUTO mode. For the details of AUTO mode, refer to "3.13 Cursor AUTO Mode".

12.5.2.1 Creating a vertex by entering the position

- 1 Click on the [Enter POSN] button on the drawing toolbar.**
The [Enter Position] dialog box appears.
- 2 Enter the latitude and longitude of the vertex of the object in the [Position] box and click on the [Enter] button.**
The position of the vertex of the object is determined.
The [Bearing] box and the [Distance] box are enabled.
- 3 Enter the values of the latitude and the longitude of the next vertex in the [Position] box. Alternatively, enter the bearing from the vertex that was determined immediately previously in the [Bearing] box and the [Distance] input box.**
- 4 Click on the [Enter] button.**
- 5 Determine the positions of 2 or more vertices by repeating Steps 2 and 3.**
- 6 Adjust the parameters on the object property dialog box.**
- 7 To create an object in another position continuously, click on the [New] button of the [Enter Position] dialog and repeat Steps from 2 to 6.**

12.5.2.2 Creating an object with EBL/VRM operation

- 1 Click on the [EBL/VRM] button on the drawing toolbar.**
The cursor changes to the EBL/VRM reference point cursor. (Refer to "12.2.5 Creating an object in the EBL/VRM mode".)
- 2 Click on the position of the reference point of the EBL/VRM marker.**
The EBL/VRM marker is displayed.
- 3 Place the EBL/VRM marker on the starting point and click the button.**
A vertex is created on the position on which the button was clicked and the information is reflected in the object property dialog box. (Refer to "12.2.8 Object property dialog box".)

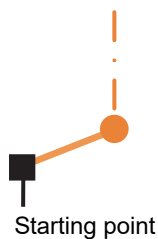

- 4 Click on the position of the reference point.**
The EBL/VRM marker that determines the 2nd point is displayed.

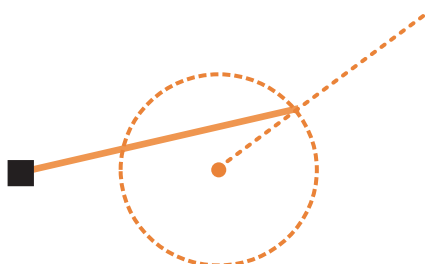

5 Place the EBL/VRM marker on the 2nd vertex and click the button.

A vertex is created on the position on which the button was clicked and the information is reflected in the object property dialog box. (Refer to "12.2.8 Object property dialog box".)

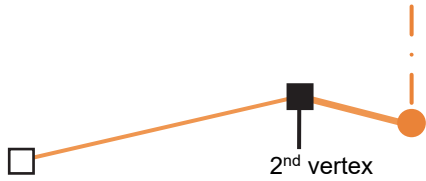

The EBL/VRM marker is reset to the EBL/VRM reference point cursor.

6 Adjust the parameters on the object property dialog box.

7 To create an object on another position continuously, repeat Steps 2 to 6.

12.5.3 Creating a circle, ellipse, and an arc (Line object)

A circle, an ellipse, and arc can be drawn with the cursor by specifying the center.

1 Click on the [Type] button on the drawing toolbar.

An icon list is opened.

2 Select an icon of a circle, an ellipse, or an arc.

(Refer to "12.2.3 Selecting an object type".)

3 Click on the position for the center with the cursor.

The center is created and the property information on the vertex is displayed on the object property dialog box.

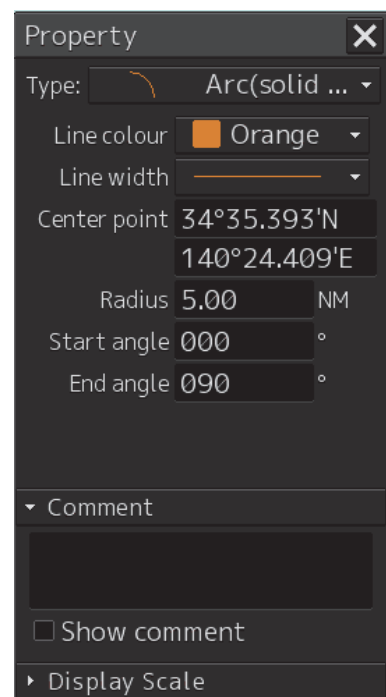
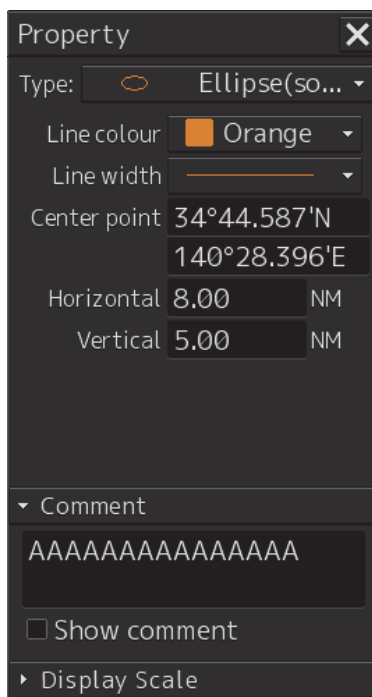
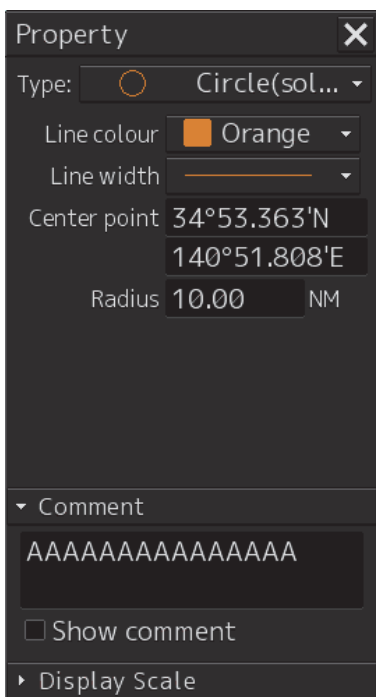

4 Draw a circle, an ellipse, or an arc.

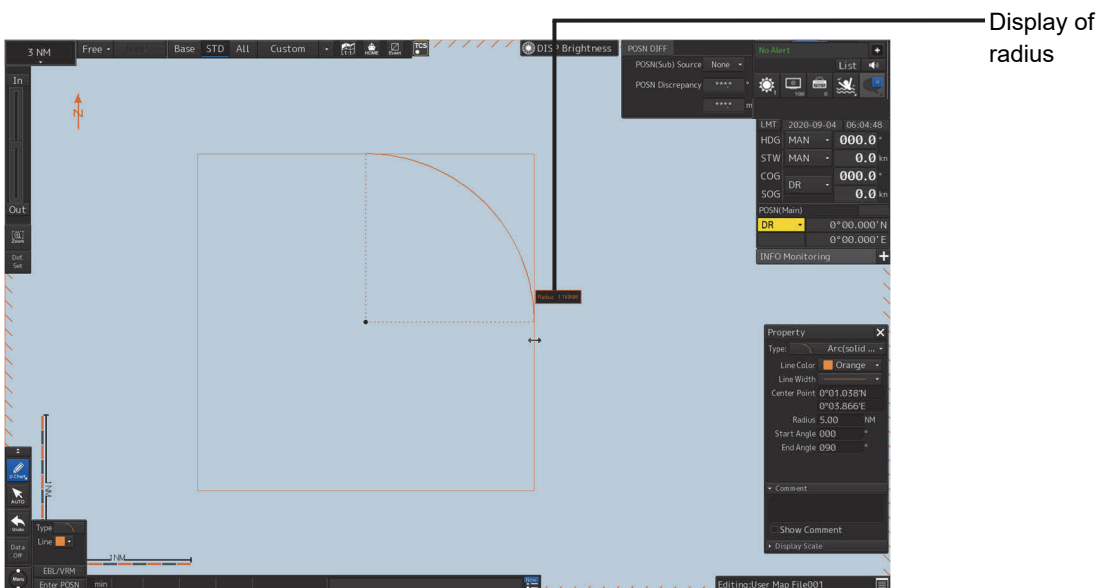
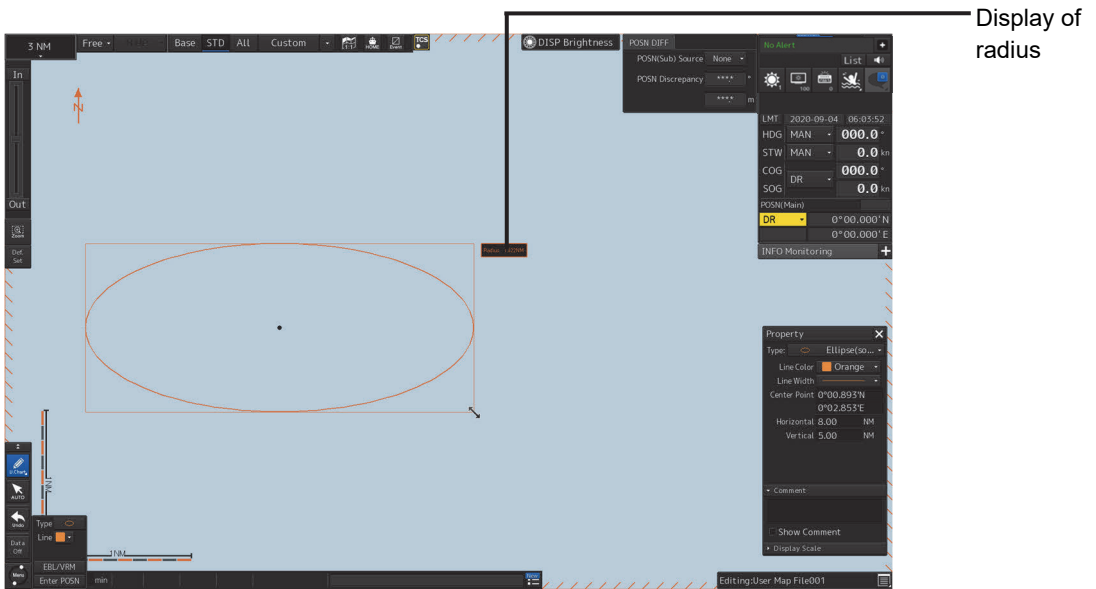
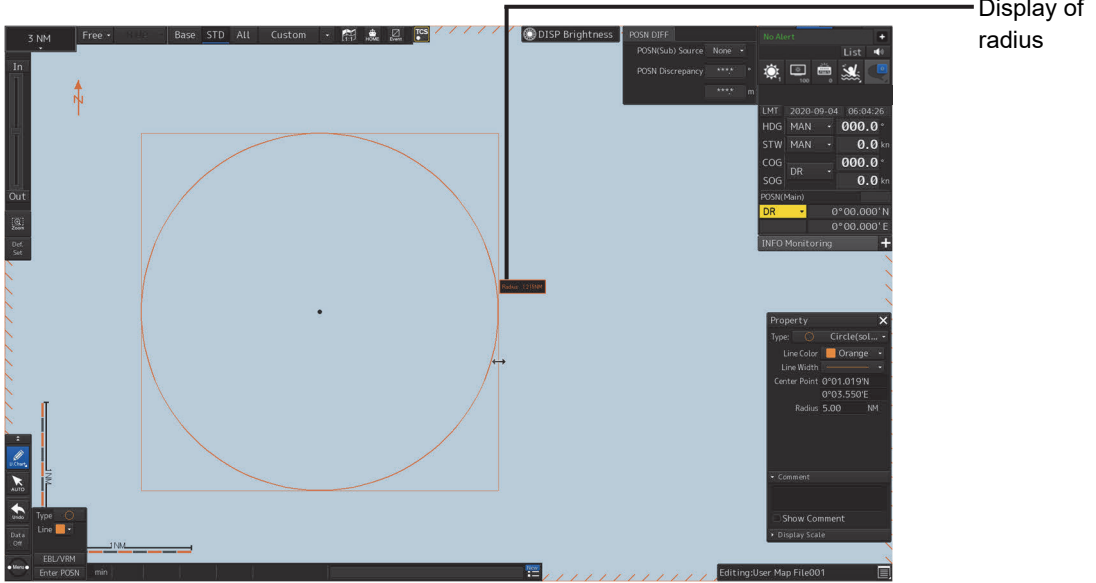

At creation of an arc, the starting angle and the ending angle of the arc to be created are the previous values or the initial values (starting angle: 0°, ending angle: 90°). To change the starting angle and the ending angle, change the values in [Start Angle] and [End Angle] on the object property dialog box.

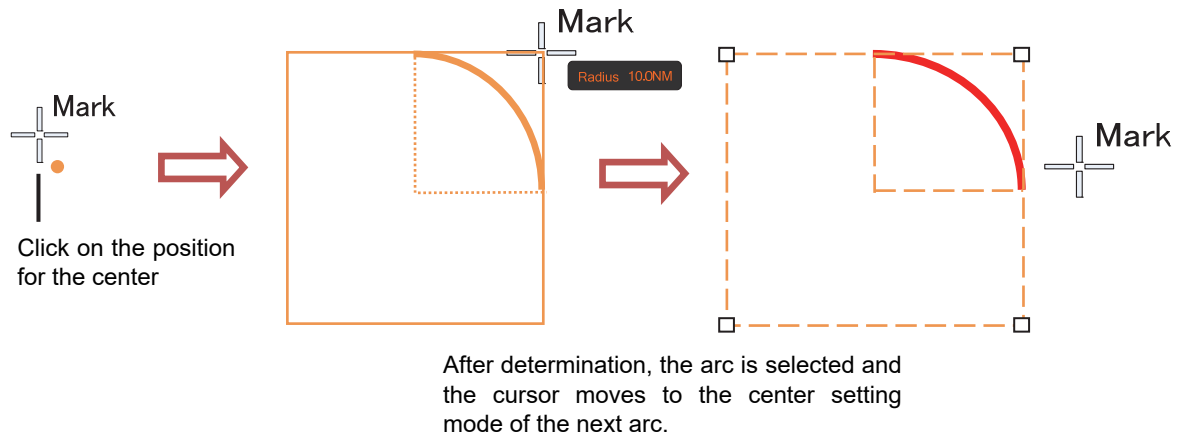

- 5 Determine the object by clicking the button again.**
- 6 Adjust the parameters on the object property dialog box.**
- 7 To create an object on another position continuously, repeat Steps 3 to 6.**

12.5.3.1 Creating an object by specifying a position for the center and size of the object

- 1 Click on the [Enter POSN] button on the drawing toolbar.**
The [Enter Position] dialog box appears. (Refer to "12.2.6 Creating an object by specifying latitude and longitude".)
- 2 Enter the coordinate of the center of the circle, ellipse, or arc and click on the [Enter] button of the [Enter Position] dialog box.**
The center is created at the position of the specified coordinate and the property information is reflected in the object property dialog box. (Refer to "12.2.8 Object property dialog box".)
- 3 Set the parameters in the object property dialog box as indicated below.**
 - Circle: Enter a value of [Radius].
 - Ellipse: Enter values of [Horizontal] and [Vertical].
 - Arc: Enter values of [Radius], [Start Angle], and [End Angle].
- 4 To create an object on another position continuously as required, repeat Steps 2 and 3.**

12.5.4 Creating a polygon and Alerts area (Area object)

Create a polygon using all the vertices (3 or more) as one object. Alerts area is an area object that is detected as a warning target (danger area).

A polygon and Alerts area can be created in the same way as for simple line and Alerts line

1 Click on the [Type] button on the drawing toolbar.

An icon list is opened.

Select an icon of a polygon or a Alerts area. (Refer to "12.2.3 Selecting an object type".)

2 Click on the starting point position with the cursor.

The starting point is created and the property information of vertex 1 is displayed on the object property dialog box.

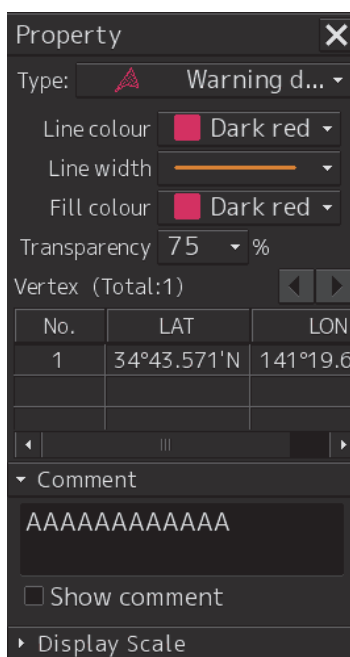
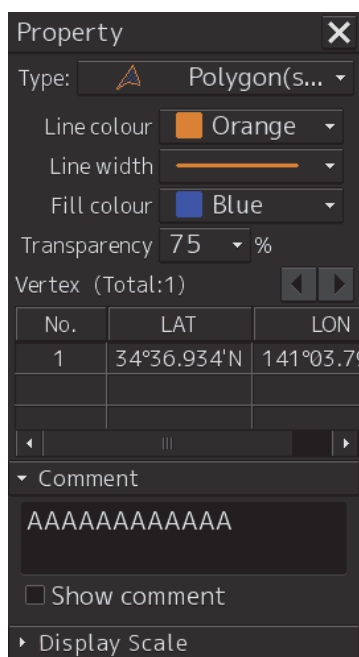

The latitude and longitude of the starting point (vertex 1) are displayed.

3 Move the cursor to the next vertex.

The latitude and longitude of the cursor are displayed near the cursor.



4 Click on the position on which the 2nd vertex is to be created.

A vertex is created and the latitude and the longitude of the 2nd vertex are displayed on the object property dialog box

The diagram illustrates the process of adding a second vertex to a line. On the left, a white square represents the starting point, and a black square represents the second vertex. An orange line connects them. A crosshair labeled 'Mark' is positioned above the second vertex. Below the diagram, two labels with arrows point to the vertices: 'Resetting the starting point selection state' and 'Add the 2nd point'. To the right, a 'Property' dialog box is shown with the following settings:

- Type: Warning d...
- Line colour: Dark red
- Line width: [Slider]
- Fill colour: Dark red
- Transparency: 75 %
- Vertex (Total:1): [Buttons]
- Table:

| No. | LAT | LON |
|-----|-------------|-----------|
| 1 | 34°43.571'N | 141°19.6' |
- Comment: AAAAAAAAAAAAA
- Show comment:
- Display Scale: [Dropdown]

Annotations on the right side of the dialog box:

- 'Editing of the line color and width is enabled.' points to the Line colour and Line width fields.
- 'The number of vertices becomes 2.' points to the Vertex (Total:1) field.
- 'The coordinates of the 2nd point are entered.' points to the table row.

5 Click on the position on which the 3rd vertex is to be created.

A triangle is created by connecting the three vertices. A preview screen is displayed, enabling the checking of the fill statuses of the polygon and the Alerts area.

The diagram shows a light blue area representing water and a green area representing land. A triangle is formed by three vertices, with the area inside filled with a light orange color. A crosshair is positioned at the third vertex. An arrow points from the text 'The preview of the result of filling the area is displayed.' to the filled triangle.

The latitude and longitude of the 3rd vertex are displayed on the object property dialog box.

-
-
- 6 To add another vertex continuously, click on the position on which the vertex is to be created.**

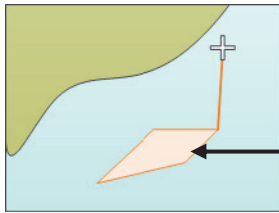

When the 4th vertex is determined, the preview display is updated.

When not adding any further vertices, determine the polygon or the Alerts area by double-clicking the button or clicking the right button.

- 7 Adjust the parameters on the object property dialog box.**
- 8 To create an object on another position continuously, repeat Steps 2 to 7.**

12.5.4.1 Creating a vertex by entering the position

- 1 Click on the [Enter POSN] button on the drawing toolbar.**
The [Enter Position] dialog box appears.
- 2 Enter the latitude and longitude of the vertex of the object in the [Position] box and click on the [Enter] button.**
The position of one vertex of the object is determined.
The [Bearing] box and the [Distance] box are enabled.
- 3 Enter the values of the latitude and the longitude of the next vertex in the [Position] box. Alternatively, enter the bearing from the vertex that was determined immediately previously in the [Bearing] box and the [Distance] input box.**
- 4 Click on the [Enter] button.**
- 5 Determine 3 or more vertices by repeating Steps 2 to 4.**
- 6 Adjust the parameters on the object property dialog box.**
- 7 To create an object on another position continuously, repeat Steps 2 to 6.**

12.5.4.2 Creating an object with EBL/VRM operation

- 1 Click on the [EBL/VRM] button on the drawing toolbar.**
The cursor changes to the EBL/VRM reference point cursor. (Refer to "12.2.5 Creating an object in the EBL/VRM mode".)
- 2 Click on the position of the reference point of the EBL/VRM marker.**
The EBL/VRM marker is displayed.
- 3 Place the EBL/VRM marker on the starting position and click the mouse button.**

A vertex is created on the position on which the button was clicked and the parameter information is reflected on the object property dialog box. (Refer to "12.2.8 Object property dialog box".)

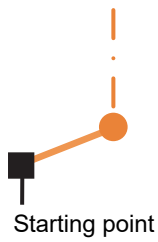

4 Click on the position of the reference point.

The EBL/VRM marker that determines the 2nd vertex is displayed.

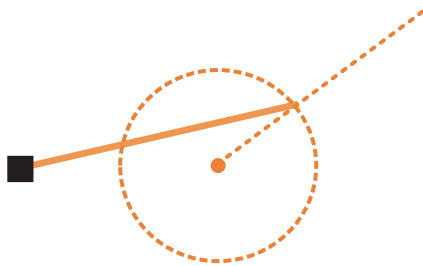

5 Place the EBL/VRM marker on the 2nd vertex position and click the button.

A vertex is created on the position on which the button was clicked and the property information is reflected in the object property dialog box. (Refer to "12.2.8 Object property dialog box".)

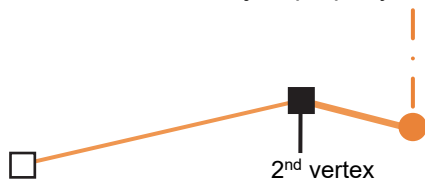

The EBL/VRM marker is reset to the EBL/VRM reference point cursor.

6 Place the EBL/VRM marker on the position of the 3rd vertex and click the button.

A triangle is created by connecting the three vertices. The preview screen is displayed, enabling the checking of the fill state of the polygon and Alerts area.

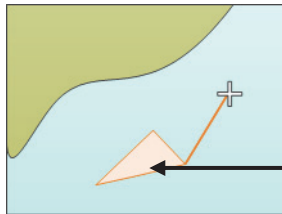

Preview of the area fill result is displayed.

7 Adjust the parameters on the object property dialog box.

8 To create an object on another position continuously, repeat Steps 1 to 7.

12.5.5 Creating circle, ellipse, and fan areas (Area object)

Circle, ellipse, and fan areas can be created in the same way as for creating a circle, an ellipse, or an arc of the Line object.

1 Click on the [Type] button on the drawing toolbar.

An icon list is opened.

2 Select an icon of circle, ellipse, or arc. (Refer to "12.2.3 Selecting an object type".)

3 Click on the position to be the center with the cursor.

A center is created and the vertex property information is displayed on the object property dialog box.

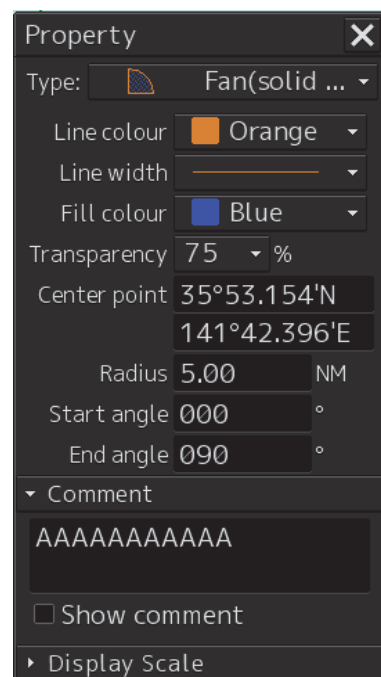
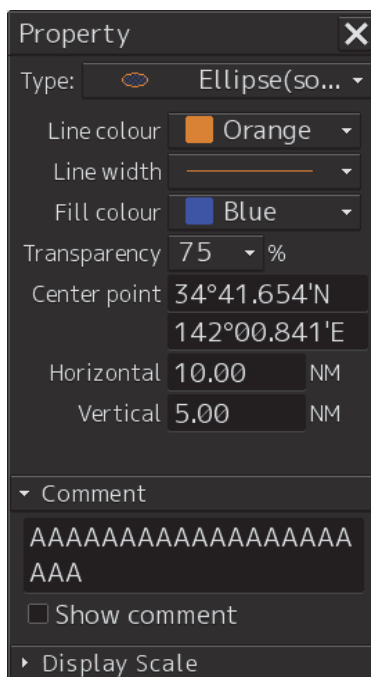
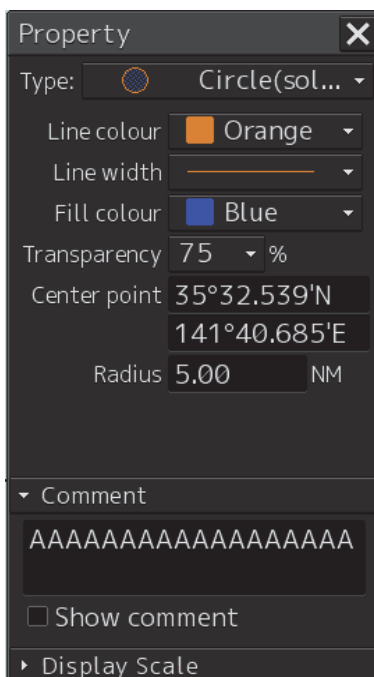

4 Draw a circle, an ellipse, and an arc.

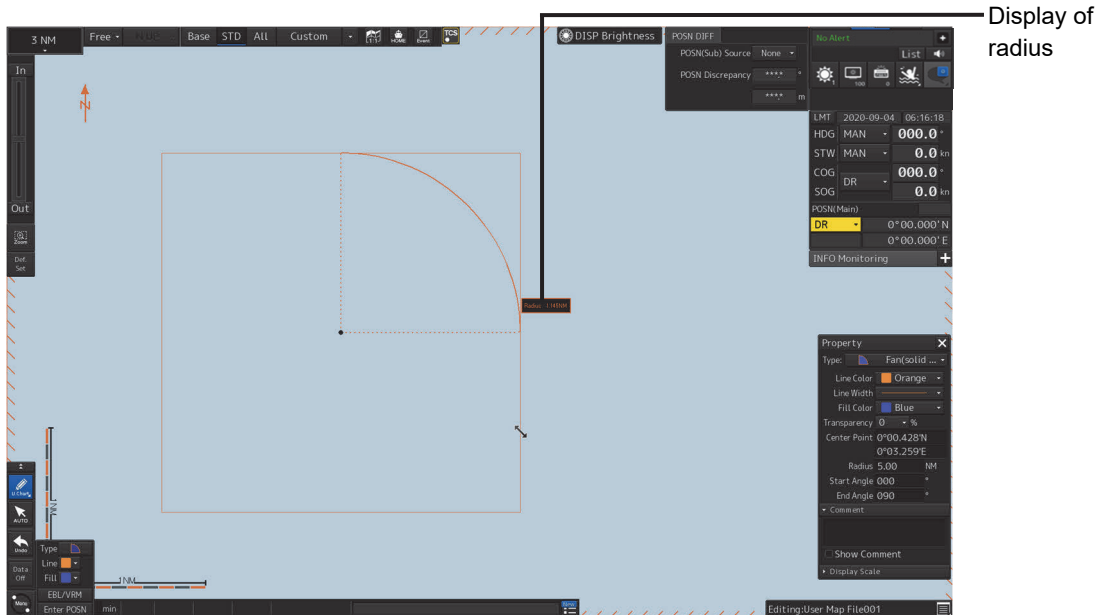
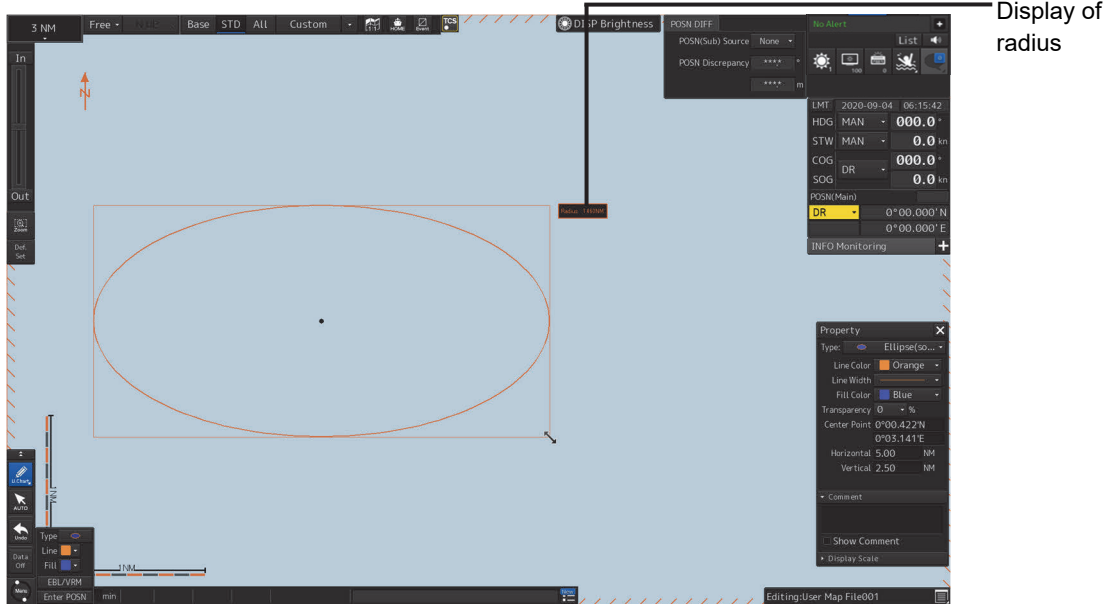
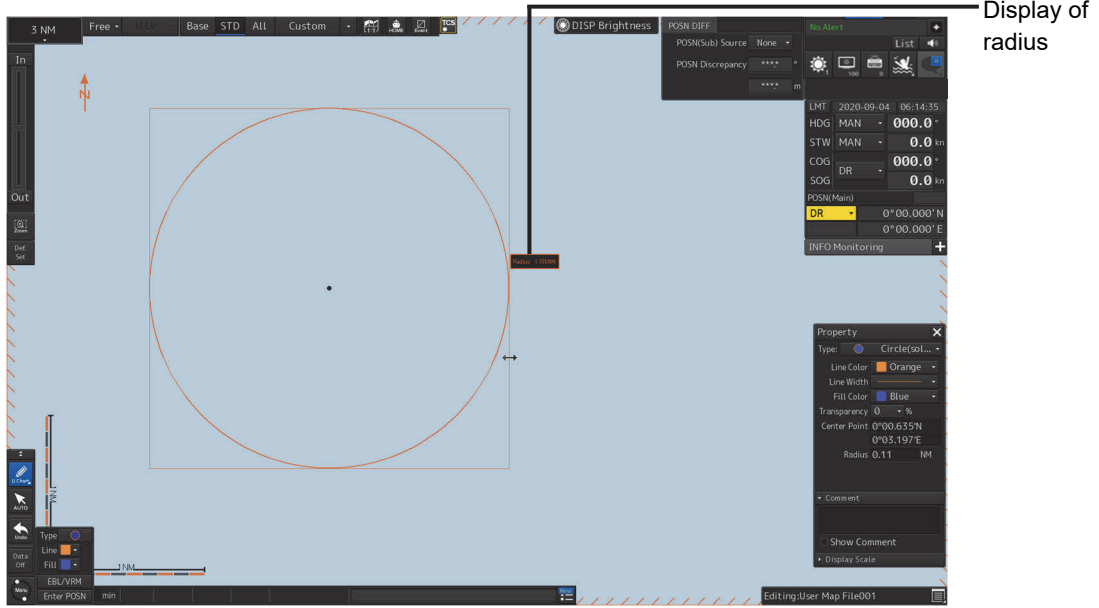

At creation of an arc, the starting angle and the ending angle of the arc to be created are the previous values or the initial values (starting angle: 0°, ending angle: 90°). To change the starting angle and the ending angle, change the values in [Start Angle] and [End Angle] on the object property dialog box.

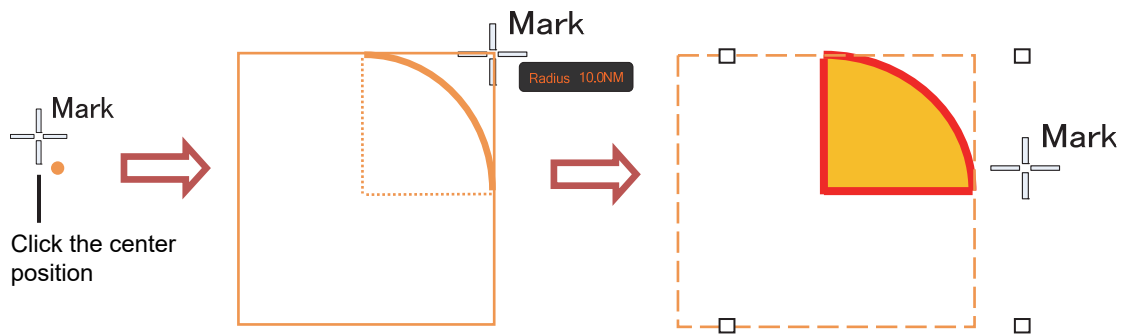

After determination, the arc is selected and the cursor moves to the center setting mode for the next arc.

- 5 Determine the object by clicking the button again.**
- 6 Adjust the parameters on the object property dialog box.**
- 7 To create an object on another position continuously, repeat Steps 3 to 6.**

12.5.5.1 Creating an object by specifying the center position and the object size

- 1 Click on the [Enter POSN] button on the drawing toolbar.**
The [Enter Position] dialog box appears (Refer to "12.2.6 Creating an object by specifying latitude and longitude".)
- 2 Enter the coordinates of the center of the circle, ellipse, or arc and click on the [Enter] button on the [Enter Position] dialog box.**
A center point is created on the position of the specified coordinates and the property information is reflected in the object property dialog box (Refer to "12.2.8 Object property dialog box".)
- 3 Set the following parameters on the object property dialog box.**
 - Circle: Enter a value of [Radius].
 - Ellipse: Enter values of [Horizontal] and [Vertical].
 - Arc: Enter values of [Radius], [Start Angle], and [End Angle].
- 4 To create an object on another position continuously as required, repeat Steps 2 and 3.**

12.5.6 Creating a text (Text object)

Any character information can be displayed on the user chart.

1 Click on the [Type] button on the drawing toolbar.

An icon list is opened.

Select a text (Txt) icon. (Refer to "12.2.3 Selecting an object type".)

2 With the cursor, click on the position on which an object is to be created.



A text box is created at the position on which the button was clicked and a text is displayed.



The parameters of the text that was created are displayed on the object property dialog box.

Property

Type: Text

Colour Orange

Font size 11 (Small)

Position 35°17.369'N
142°10.992'E

Angle 008 °

Text

Text

Edit template...

Comment

AAAAAAAAAAAA

Display Scale

Select a character color from the list.

Select a character size from the list.

Enter the coordinates of the text display position.

Enter the angle from the 12 O'clock bearing when angling the text.

Enter a text (up to 64 characters).

To use a template, select a template from the list by clicking the button.

3 Adjust the parameters on the object property dialog box.

For the text input method, refer to "12.5.6.3 Editing a text", for the template usage method, refer to "12.5.6.4 Editing a template", and for the text angling method, refer to "12.5.6.5 Changing a text angle".

4 To create an object on another position continuously, repeat Steps 2 and 3.

12.5.6.1 Creating a text by specifying the latitude and longitude

1 Click on the [Enter POSN] button on the drawing toolbar.

The [Enter Position] dialog box appears (Refer to "12.2.6 Creating an object by specifying latitude and longitude".)

2 Enter the latitude and longitude of the object to be created and click on the [Enter] button.

An object is created on the specified latitude and longitude and the property information is reflected in the object property dialog box. (Refer to "12.2.8 Object property dialog box".)

3 Adjust the parameters on the object property dialog box.

For the text input method, refer to "12.5.6.3 Editing a text", for the template usage method, refer to "12.5.6.4 Editing a template", and for the text angling method, refer to "12.5.6.5 Changing a text angle".

4 To create an object on another position continuously, repeat steps 2 and 3.

12.5.6.2 Creating a text with EBL/VRM operation

1 Click on the [EBL/VRM] button on the drawing toolbar.

The cursor changes to the EBL/VRM reference point cursor. (Refer to "12.2.5 Creating an object in the EBL/VRM mode".)

2 Click on the position of the reference point position of the EBL/VRM marker.

The EBL/VRM marker is displayed.

3 Place the EBL/VRM marker on the position on which an object is to be created and click the button.

An object is created on the position on which the button was clicked and the property information is reflected in the object property dialog box. (Refer to "12.2.8 Object property dialog box".)

4 Adjust the parameters on the object property dialog box.

For the text input method, refer to "12.5.6.3 Editing a text", for the template usage method, refer to "12.5.6.4 Editing a template", and for the text angling method, refer to "12.5.6.5 Changing a text angle".

5 To create an object on another position continuously, repeat Steps 2 to 4.

12.5.6.3 Editing a text

1 Click on the [Text] input box

A character input full keyboard is displayed.

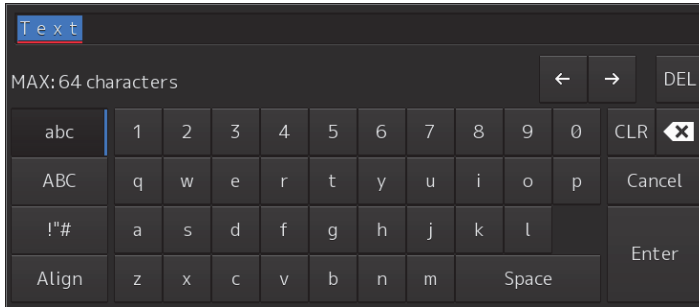

2 Create a text.

For the method of using the character input full keyboard, refer to "3.16.2 Name and function of each section of the keyboard".

3 Close the character input full keyboard by clicking on the [Enter] key.

4 To change a character color, select a required character color from the [Color] combo box.

5 To change a character size, select a required character size from the [Font size] combo box.

12.5.6.4 Editing a template

By registering a frequently used text as a template, the template can be used at text creation.

1 Click on the [Edit Template] button.

The [Template] dialog box appears.

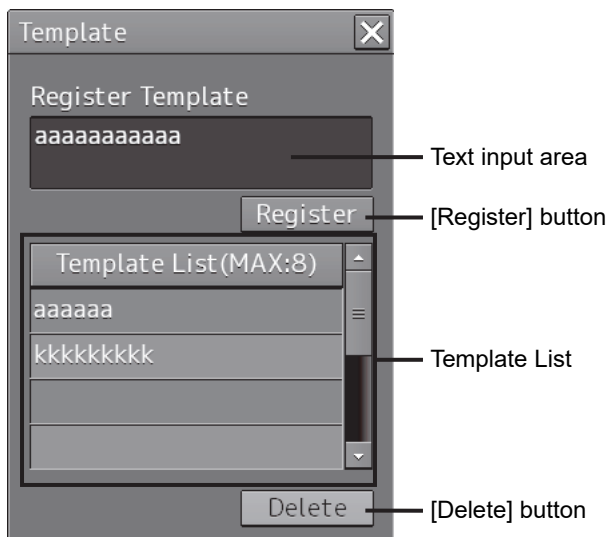

2 Click on a text input area.

A character input full keyboard is displayed.

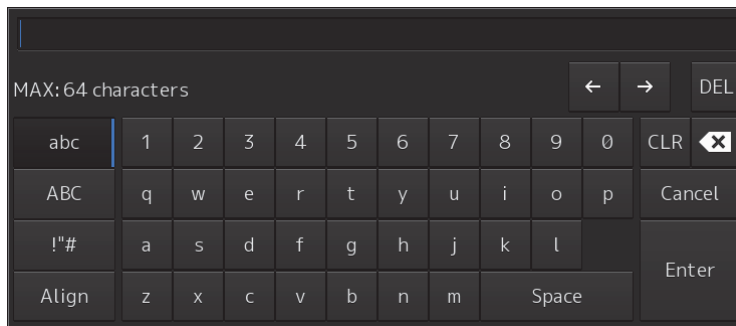

3 Create a text.

For the method of using the character input full keyboard, refer to "3.16.2 Name and function of each section of the keyboard".

4 Close the character input full keyboard by clicking on the [Enter] key.

5 Click on the [Register] button.

6 Close the [Template] dialog and click on [▼] on the right side of the text input area of the object properties dialog.

[Template List] is displayed.

7 Select any template.

8 To delete unnecessary templates, select the unnecessary templates in the [Template List] and click on the [Delete] button.

12.5.6.5 Changing a text angle

Under the factory setting, a text is oriented horizontally. The text can be angled or inverted according to the text creation position.

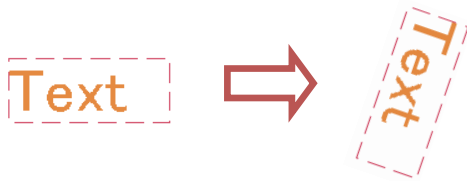

1 Click on the [Angle] input box.

A numeric value input keyboard is displayed.

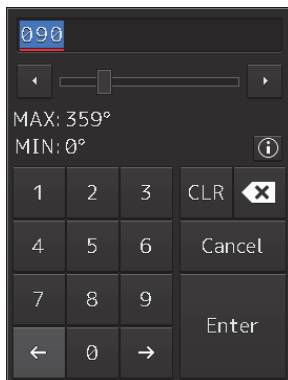

2 Enter an angle.

Specify an angle in clockwise based on the direction of the 12 O'clock as 0°. Under the factory setting, the angle is set to 90° (horizontal).

For the method of using the numeric value input keyboard, refer to "3.16.2 Name and function of each section of the keyboard".

12.5.7 Creating an arrow (Line object)

An arrow can be displayed on the user chart or chart.

1 Click on the [Type] button on the drawing toolbar.

An icon list is displayed.

2 Select the arrow icon. (Refer to "12.2.3 Selecting an object type".)

3 Click on the starting position with the cursor.

A starting point is created and the property information of the starting point is displayed on the object property dialog box.

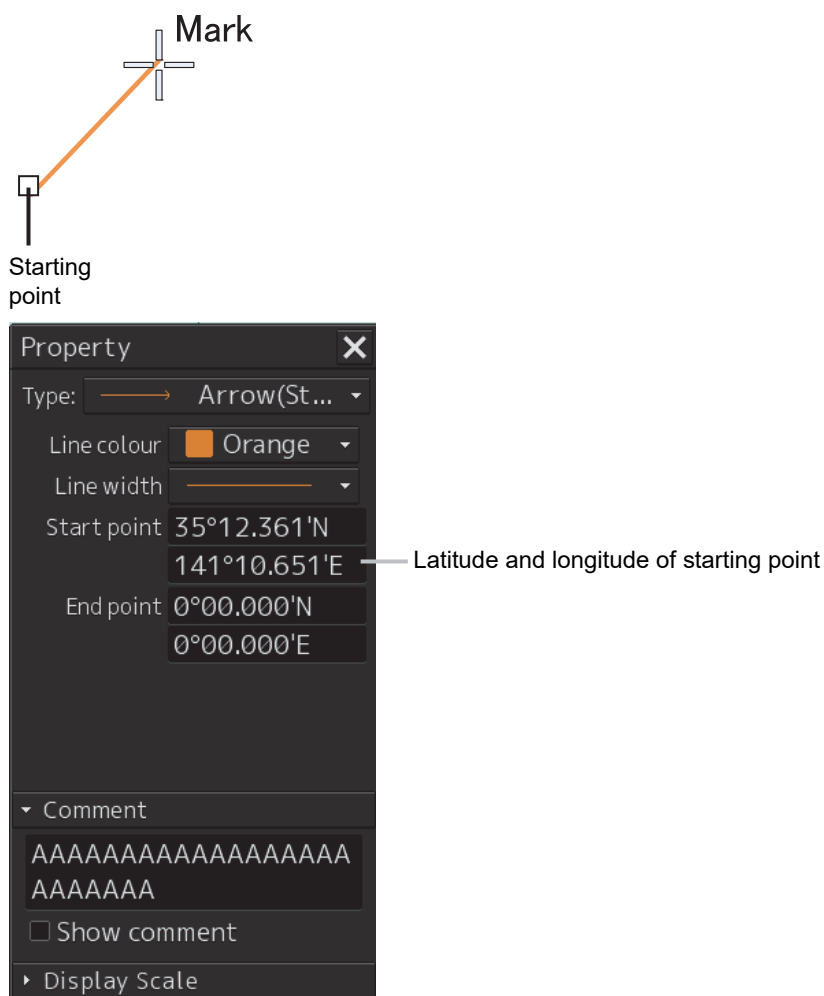

Note

The color, line type, and line width of a starting point cannot be changed.

4 Click on the position of the ending point with the cursor.

An ending point is created and the property information of the ending point is displayed on the object property dialog box.

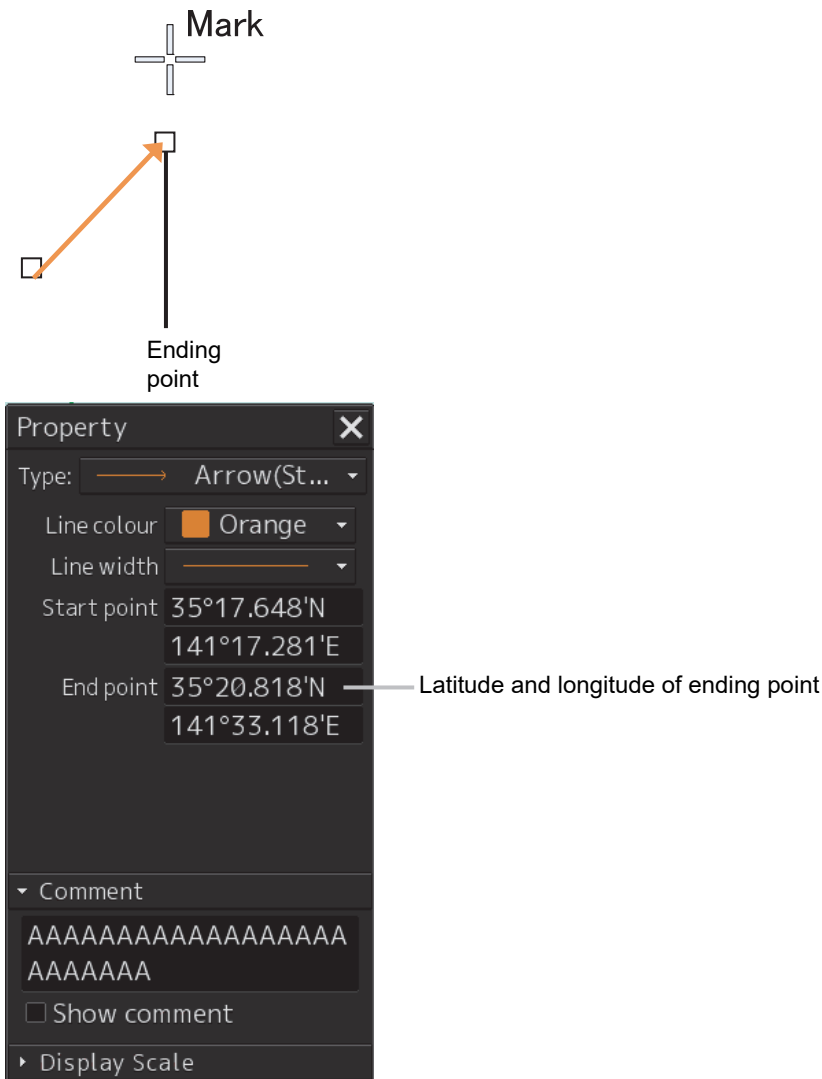

5 Adjust the parameters on the object property dialog box.

6 To create an object on another position continuously, repeat Steps to 3 to 5.

12.5.7.1 Creating an object by specifying the starting point/ending point position coordinates

1 Click on the [Enter POSN] button on the drawing toolbar.

The [Enter Position] dialog box appears (Refer to "12.2.6 Creating an object by specifying latitude and longitude".)

2 Enter the coordinates of the starting point and click on the [Enter] button.

A starting point of the arrow is created on the position of the specified coordinates and the property information is reflected in the object property dialog box. (Refer to "12.2.8 Object property dialog box".)

3 Enter the coordinates of the ending point and click on the [Enter] button.

An ending point of the arrow is created on the position of the specified coordinates and the property information is reflected in the object property dialog box.

4 To create an object on another position continuously, repeat Steps 1 to 3.

12.5.7.2 Drawing an object with EBL/VRM operation

1 Click on the [EBL/VRM] button on the drawing toolbar.

The cursor changes to the EBL/VRM reference point cursor. (Refer to "12.2.5 Creating an object in the EBL/VRM mode".)

2 Click on the position of the reference point of the EBL/VRM marker.

The EBL/VRM marker is displayed.

3 Place the EBL/VRM marker on the position of the starting point and click the button.

4 Click on the reference position of the EBL/VRM marker.

A starting point is created on the position on which the button was clicked and the property information is displayed on the object property dialog box. (Refer to "12.2.8 Object property dialog box".)

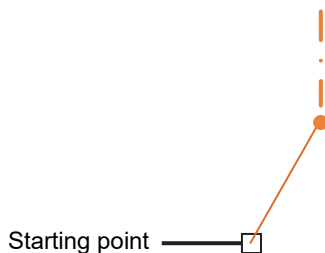

5 Place the EBL/VRM marker on the position of the ending point and click the button.

An ending point is created on the position on which the button was clicked and the property information is displayed on the object property dialog box. (Refer to "12.2.8 Object property dialog box".)

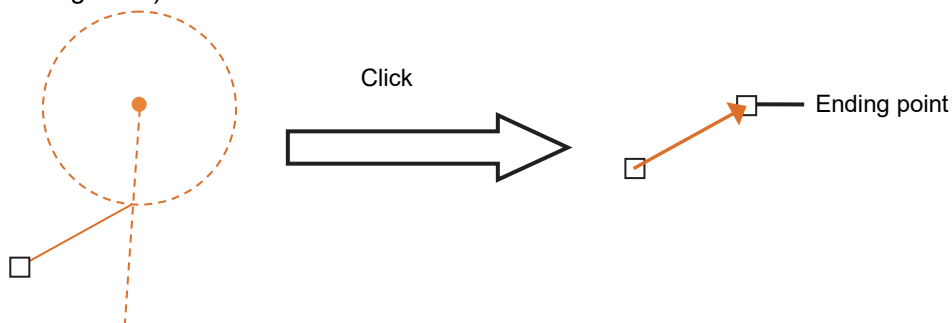

6 To create an object on another position continuously, repeat Steps 2 to 5.

12.5.8 Creating Mariner's Mark/Line drawing objects

At user chart creation, the following Mariner's Mark/Line drawing objects can be created.

- Information Mark
- Clearing Line
- Tidal Stream mark
- Highlight mark

1 Click on the [Type] button on the drawing toolbar.

An icon list is displayed.

2 Click on the [Mariner's Mark/Line] button on the icon list.

Mariner's Mark/Line drawing objects are displayed on the icon list.

3 Select an object to be created and specify a creation position.

12.5.8.1 Information mark

An information mark can be created on any position of the chart. An information mark is used for comments and so on.



Information
Mark

1 Click on the [Type] button on the drawing toolbar.

An icon list is opened.

Select the icon of information mark. (Refer to "12.2.3 Selecting an object type".)

- 2 Click on the position on which the information mark is to be created with the cursor.



The information mark is displayed on the position on which the button was clicked and the parameters of the information mark are displayed on the object property dialog box.



Latitude and longitude of the information mark creation position

- 3 Adjust the parameters on the object property dialog box.
- 4 To create an object on another position continuously, repeat Steps 2 and 3.

Creating an object by specifying the latitude and longitude

- 1 Click on the [Enter POSN] button on the drawing toolbar.
The [Enter Position] dialog box appears (Refer to "12.2.6 Creating an object by specifying latitude and longitude".)
- 2 Enter the latitude and longitude of the position on which an object is to be created and click on the [Enter] button.
An object is created on the position of the specified latitude and longitude and the property information is reflected in the object property dialog box. (Refer to "12.2.8 Object property dialog box".)
- 3 Adjust the parameters on the object property dialog box.
- 4 To create an object on another position continuously, repeat Steps 2 and 3.

Creating an object with EBL/VRM operation

- 1 Click on the [EBL/VRM] button on the drawing toolbar.**
The cursor changes to the EBL/VRM reference point cursor. (Refer to "12.2.5 Creating an object in the EBL/VRM mode".)
- 2 Click on the position of the reference point of the EBL/VRM marker.**
The EBL/VRM marker is displayed.
- 3 Place the EBL/VRM marker on the position on which an object is to be created and click the button.**
An object is created on the position on which the button was clicked and the property information reflected in the object property dialog box. (Refer to "12.2.8 Object property dialog box".)
- 4 Adjust the parameters on the object property dialog box.**
- 5 To create an object on another position continuously, repeat Steps 2 to 4.**

12.5.8.2 Clearing line

A clearing line can be created on a chart. It is possible to select an angle and either Not Less Than (NLT) or Not More Than (NMT) for a clearing line on the object property dialog box.

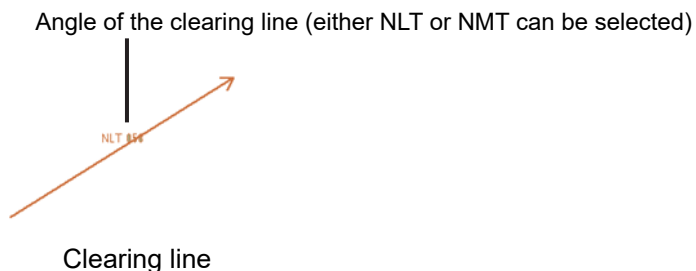

- 1 Click on the [Type] button on the drawing toolbar.**
Open the icon list and select an icon of clearing line. (Refer to "12.2.3 Selecting an object type".)
- 2 Click on the position of a starting point with the cursor.**
A starting point is created and the property information of the clearing line is displayed on the object property dialog box.

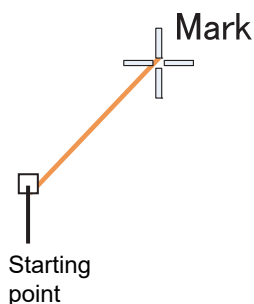

3 Click on the position of the ending point with the cursor.

An ending point is created and the property information in the object property dialog box is updated.

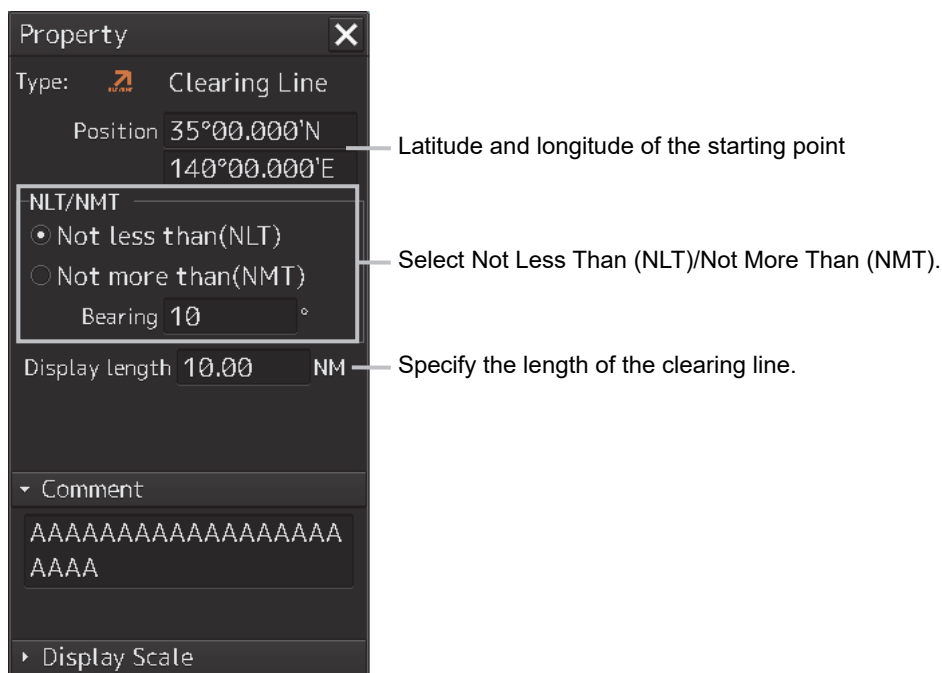
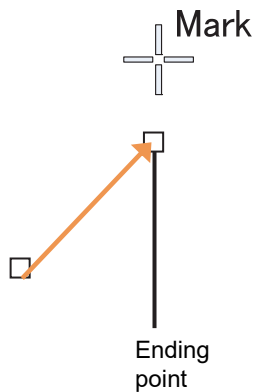

4 Adjust the parameters on the object property dialog box.

- **Specifying an angle of a clearing line:** Display a numeric value input keyboard by clicking on the [Bearing] input box and enter an angle (0 to 359°).
- **Specifying a length of a clearing line:** Display a numeric value input keyboard by clicking on the [Display length] input box and enter a length (0 to 999.99).
- **Selecting Not Less Than (NLT)/Not More Than (NMT):** Set Not Less Than (NLT) or Not More Than (NMT) to On by clicking on the button.

When Not Less Than (NLT) is selected, "NLT xx" is displayed for the clearing line, indicating that the line must not be below "xx". When Not More Than (NMT) is selected, "NMT xx" is displayed for the clearing line, indicating that the line must not exceed "xx".

For the method of using the numeric value input keyboard, refer to "3.16.2 Name and function of each section of the keyboard".

5 To create an object on another position continuously, repeat Steps 2 to 4.

Creating position coordinates of the starting point

- 1 Click on the [Enter POSN] button on the drawing toolbar.**
The [Enter Position] dialog box appears (Refer to "12.2.6 Creating an object by specifying latitude and longitude".)
- 2 Enter the coordinates of a starting point and click on the [Enter] button.**
- 3 To create an object on another position continuously, repeat Steps 1 and 2.**

Drawing an object with EBL/VRM operation

- 1 Click on the [EBL/VRM] button on the drawing toolbar.**
The cursor changes to the EBL/VRM reference point cursor. (Refer to "12.2.5 Creating an object in the EBL/VRM mode".)
- 2 Click on the position of the reference point of the EBL/VRM marker.**
The EBL/VRM marker is displayed.
- 3 Place the EBL/VRM marker on the starting point position and click the button.**
A starting point is created on the position on which the button was clicked and the property information is reflected in the object property dialog box. (Refer to "12.2.8 Object property dialog box".)

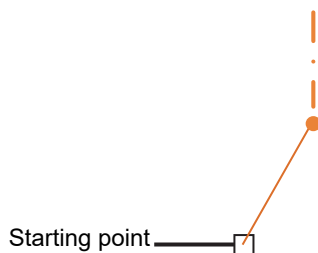

- 4 Place the EBL/VRM marker on the ending point position and click the button.**
An ending point is created on the position on which the button was clicked and the property information is reflected in the object property dialog box. (Refer to "12.2.8 Object property dialog box".)

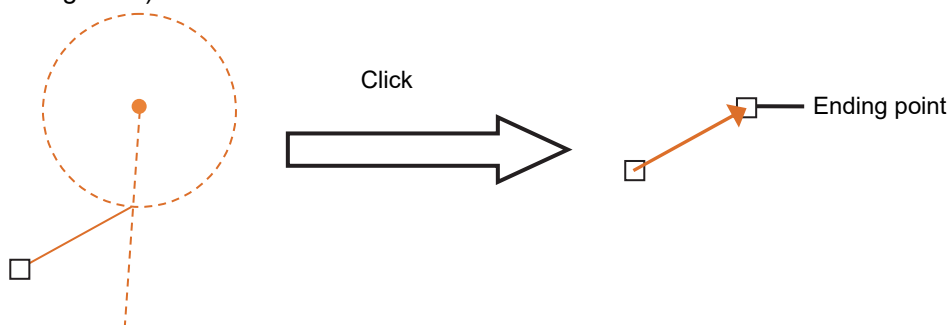

- 5 To create an object on another position continuously, repeat Steps 2 to 4.**

12.5.8.3 Tidal Stream mark

A current drift and a bearing can be input for a tidal stream mark. Edit the current drift (Drift) and the bearing (Set) after creating a tidal stream mark on the object property dialog box.

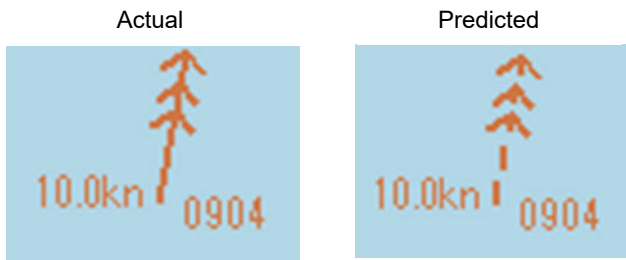

1 Click on the [Type] button on the drawing toolbar.

An icon list is opened.

Select the icon of a tidal stream mark. (Refer to "12.2.3 Selecting an object type".)

2 Click on the position on which a tidal drift mark is to be created with the cursor.



A tidal stream mark is displayed on the position on which the button was clicked and the parameters of the tidal channel mark that was created are displayed on the object property dialog box.



Property

Type: Tidal Stream

Position 35°00.000'N
140°00.000'E

Set/Drift/Time

Actual Predicted

Set 10 °

Drift 10.0 kn

Time (UTC)
2013-12-24 08:51

Comment
AAAAAAAAAAAAAAAA

Display Scale

Latitude and longitude of the starting point

Select Actual/Predicted.

Specify a bearing.

Specify a current drift.

Specify date/time.

3 Adjust the parameters on the object property dialog box.

- **Specifying a bearing:** Display a numeric value input keyboard by clicking on the [Set] input box and enter a bearing (0 to 359°).
- **Specifying a current drift:** Display a numeric value input keyboard by clicking on the [Drift] input box and enter a current drift (0 to 99.9).
- **Selecting Actual/Predicted:** Select the check box of either Actual or Predicted. When Actual is selected, a tidal stream mark of a solid line is displayed. When Predicted is selected, a tidal mark of a broken line is displayed.
- **Specifying date/time:** Display a calendar + time picker by clicking on the calendar button and enter a date and a time in the [Time(UTC)] input box.

For the method of using a numeric value input keyboard, refer to "3.16.2 Name and function of each section of the keyboard" and for the method of using a calendar + time picker, refer to "3.17 Setting a Date and a Time (Calendar Operation)".

4 To create an object on another position continuously, repeat Steps 2 and 3.

Moving a tidal stream mark

- 1 Click the right mouse button on the tidal stream mark that is set.
The menu is displayed.
- 2 Click on [Move this object].
- 3 Click on the required destination position.

Creating an object by specifying the latitude and longitude

- 1 Click on the [Enter POSN] button on the drawing toolbar.
The [Enter Position] dialog box appears (Refer to "12.2.6 Creating an object by specifying latitude and longitude".)
- 2 Enter the latitude and longitude of the position on which an object is to be created and click on the [Enter] button.
An object is created on the position of the specified latitude and longitude and the property information is reflected in the object property dialog box. (Refer to "12.2.8 Object property dialog box".)
- 3 Adjust the parameters on the object property dialog box.
- 4 To create an object on another position continuously, repeat Steps 2 and 3.

Creating an object with EBL/VRM operation

- 1 Click on the [EBL/VRM] button on the drawing toolbar.**

The cursor changes to the EBL/VRM reference point cursor. (Refer to "12.2.5 Creating an object in the EBL/VRM mode".)
- 2 Click on the position of the reference point of the EBL/VRM marker.**

The EBL/VRM marker is displayed.
- 3 Place the EBL/VRM marker on the position on which an object is to be created and click the button.**

An object is created on the position on which the button was clicked and the property information reflected in the object property dialog box. (Refer to "12.2.8 Object property dialog box".)
- 4 Adjust the parameters on the object property dialog box.**
- 5 To create an object on another position continuously, repeat Steps 2 to 4.**

12.5.8.4 Highlighted display

Highlighted display can be set by creating an area of a polygon on a chart. Use highlighted display for attaching a comment on the chart or so on.

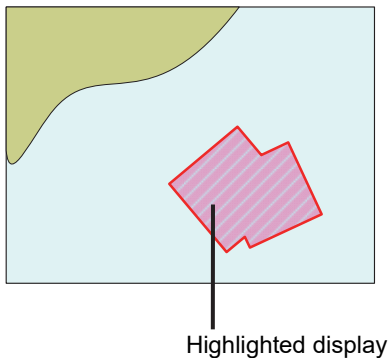

- 1 Click on the [Type] button on the drawing toolbar.**

An icon list is opened.
Select an icon of highlighted display. (Refer to "12.2.3 Selecting an object type".)

2 Click on the position of a starting point with the cursor.

A starting point is created and the property information of vertex 1 is displayed on the object property dialog box.

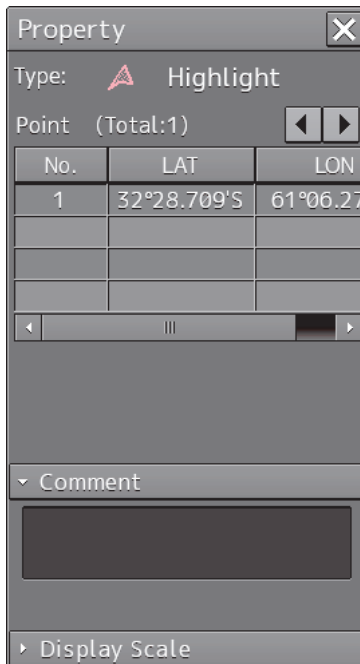

The latitude and longitude of the starting point (vertex 1) is displayed.

3 Move the cursor to the next vertex.

The latitude and longitude of the cursor are displayed near the cursor.

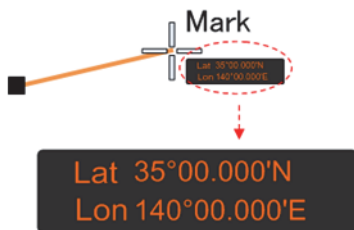

4 Click on the position on which the 2nd vertex is to be created.

A vertex is created and the latitude and longitude of the 2nd vertex are displayed on the object property dialog box.

The diagram illustrates the process of adding a second vertex to a line segment. On the left, a white square represents the starting point, and a black square represents the second vertex. An orange line connects them. A crosshair labeled 'Mark' is positioned at the end of the line. Labels indicate 'Resetting the selection of the starting point' and 'Add the 2nd vertex'. To the right, the 'Property' dialog box is shown with the following details:

- Type: Highlight
- Point (Total:2) with left and right arrow buttons. A label points to these buttons: 'The number of vertices becomes 2.'
- Table with columns: No., LAT, LON

| No. | LAT | LON |
|-----|-------------|----------|
| 1 | 32°28.709'S | 61°06.27 |
| 2 | 32°26.916'S | 61°06.02 |
| | | |
| | | |

- A label points to the second row of the table: 'The coordinates of the 2nd vertex are entered.'
- Buttons: Comment (expanded), Display Scale (collapsed)

5 Click on the position on which the 3rd vertex is to be created.

A triangle is created by connecting three vertices. The preview screen is displayed, enabling the object fill status.

The preview screen shows a map with a green landmass and a blue sea. A triangle is formed by three vertices, with the area between them filled with a light orange color. A crosshair is positioned at the third vertex. A label points to the filled triangle: 'The preview of the result of filling the object is displayed.'

The latitude and longitude of the 3rd vertex are displayed on the object property dialog box.

Property ✕

Type:  Highlight

Point (Total:3) ◀ ▶

| No. | LAT | LON |
|-----|-------------|----------|
| 1 | 32°28.709'S | 61°06.27 |
| 2 | 32°26.916'S | 61°06.02 |
| 3 | 32°27.149'S | 61°04.0 |

Comment

Display Scale

The number of vertices becomes 3.

The coordinates of the 3rd vertex are entered.

- 6 To add another vertex continuously, click on the position on which the vertex is to be created.**

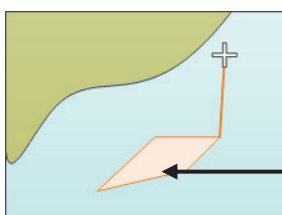

When the 4th vertex is determined, the preview display is updated.

When not adding another vertex, determine the object by double-clicking or clicking the right button on the object.

- 7 Adjust the parameters on the object property dialog box.**
- 8 To create an object on another position continuously, click on the [New] button in the [Enter Position] dialog and repeat Steps from 2 to 7.**

Creating a vertex by entering the position

- 1 Click on the [Enter POSN] button on the drawing toolbar.**
The [Enter Position] dialog box appears.
- 2 Enter the values of latitude and longitude of the vertex of the object in the [Position] box and click on the [Enter] button.**
The position of one vertex of the object is determined.
The [Bearing] box and the [Distance] box are enabled.
- 3 Enter the values of latitude and longitude of the next vertex of the object in the [Position] box. Alternatively, enter the bearing from the vertex that was determined immediately previously in the [Bearing] box and the [Distance] input box.**
- 4 Click on the [Enter] button.**
- 5 Determine the positions of 3 or more vertices by repeating Steps 2 to 4.**
- 6 Adjust the parameters on the object property dialog box.**
- 7 To create an object on another position continuously, repeat Steps 2 to 6.**

Creating an object with EBL/VRM operation

- 1 Click on the [EBL/VRM] button on the drawing toolbar.**
The cursor changes to the EBL/VRM reference point cursor. (Refer to "12.2.5 Creating an object in the EBL/VRM mode".)
- 2 Click on the position of the reference point of the EBL/VRM marker.**
The EBL/VRM marker is displayed.
- 3 Placing the EBL/VRM marker on the position of the starting point and click the button.**
A vertex is created on the position on which the button was clicked, and the property information is displayed on the object property dialog box. (Refer to "12.2.8 Object property dialog box".)

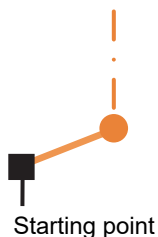

- 4 Click on the reference point.**
The EBL/VRM marker is displayed to determine the 2nd vertex.

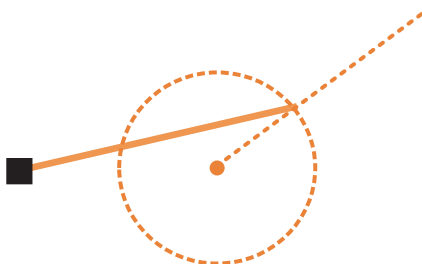

5 Place the EBL/VRM marker on the position of the 2nd vertex and click the button.

A vertex is created on the position on which the button was clicked and the property information is reflected in the object property dialog box. (Refer to "12.2.8 Object property dialog box".)

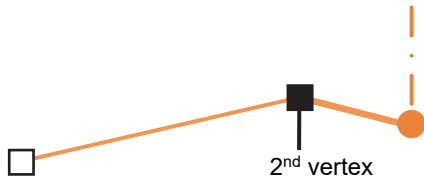

The EBL/VRM marker is reset to the EBL/VRM reference point cursor.

6 Place the EBL/VRM marker on the position of the 3rd vertex and click the button.

A triangle is created by connecting the three vertices. A preview screen is displayed, enabling the checking of the fill status of the polygon and the Alerts area.

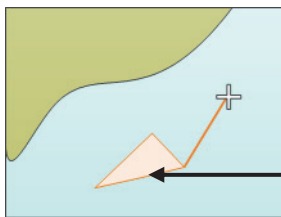

The preview of the result of filling the area is displayed.

7 Adjust the parameters on the object property dialog box.

8 To create an object on another position continuously, repeat Steps 1 to 7.

12.6 Collective Deletion of Objects [Delete by Type/Color]

Objects of the same shape and color can be deleted collectively by "Delete by Type/Color".

- 1 Click on the [Menu] button on the left toolbar.**
The menu is displayed.
- 2 Click on the [User Chart] button on the menu.**
- 3 Click on the [Delete by Type/Color] (Collective deletion) on the submenu.**
The [Delete by type/color] dialog box appears.

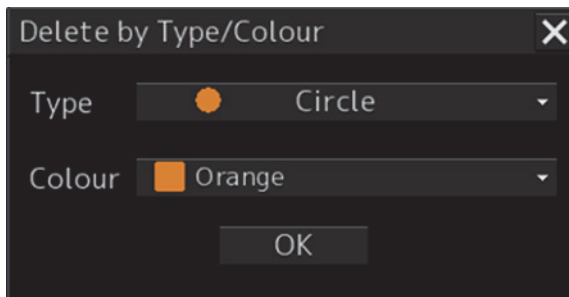

[Delete by type/color] dialog box

- 4 Elect the common parameters for the objects to be deleted from the lists of the [Type] combo box and the [Color] box.**
When [All] is selected, all the objects are deleted.
- 5 Click the [OK] button.**

Note

- If the color that is specified in the [Color] box matches any of the point color, line color and area color of the object, the object is targeted for deletion.

12.7 Managing/Editing Objects [Mark Line/List]

User charts and Mariner's Mark/Line objects can be managed/edited through [Mark/Line List].

12.7.1 Displaying the [Mark/Line List] dialog box

- 1 Click on the [Menu] button on the left toolbar.
The menu is displayed.
- 2 Click on the [User Chart] button on the menu.
- 3 Click on the [Mark/Line List] (Object list) on the submenu.
The [Mark/Line List] dialog box appears.

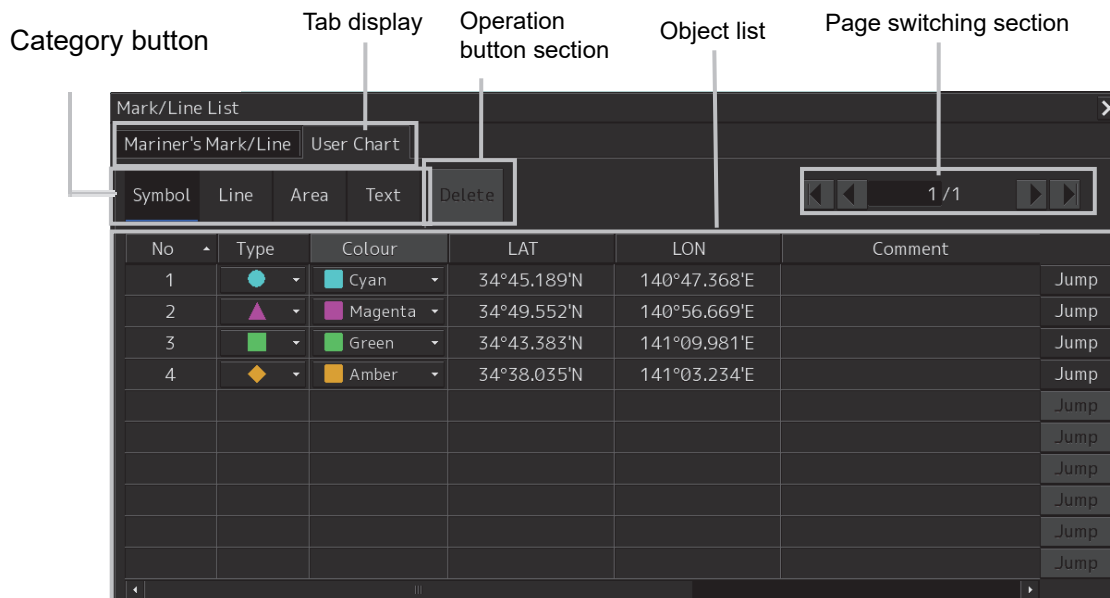

[Mark/Line List] dialog box (Display example of [User Chart] tab)

The tabs in the [Mark/Line List] dialog box consist of the following.

- **[User Chart] tab**
 - Symbol
 - Line
 - Area
 - Text
- **[Mariner's Mark/Line] tab (only the ECDIS screen and at creation of user map only)**
 - Event Mark
 - Information Mark
 - Tidal Stream
 - Highlight (highlighted display)
 - Clearing Line(Refer to "12.7.3 Displaying a Mariner's Mark/Line List".)

12.7.2 Displaying a user chart list

The [User **Chart**] tab displays a list of the user charts that are currently displayed.

The display of each category can be switched by clicking on the [Symbol] button/[Line] button/[Area] button/[Text] button.

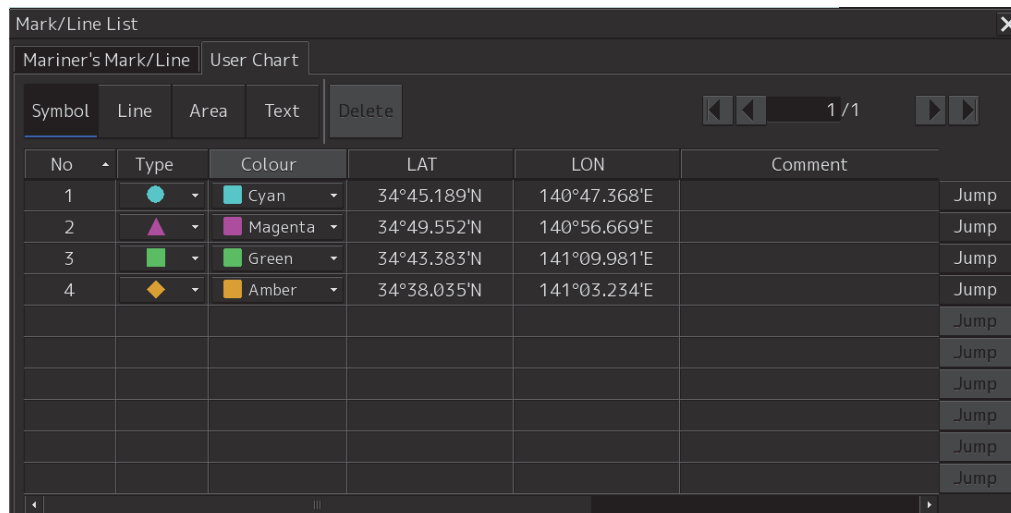

[User **Chart**] tab (example at selection of [Symbol])

12.7.2.1 Displaying an object on a chart

Click on the [Jump] button on the row of the object to be displayed on the chart.

12.7.2.2 Deleting an object

Select the row of the object to be deleted and click on the [Delete] button.

Note

As soon as the [Delete] button is clicked on, the object is deleted. Re-check whether the object can be deleted before clicking on the [Delete] button.

12.7.3 Displaying a Mariner's Mark/Line List

A Mariner's Mark/Line can be displayed by using the [Mariner's Mark/Line] tab.

Display of each category can be switched by clicking on the [Event Mark] button/[Information Mark] button/[Tidal Stream] button/[Highlight] button/[Clearing Line] button.

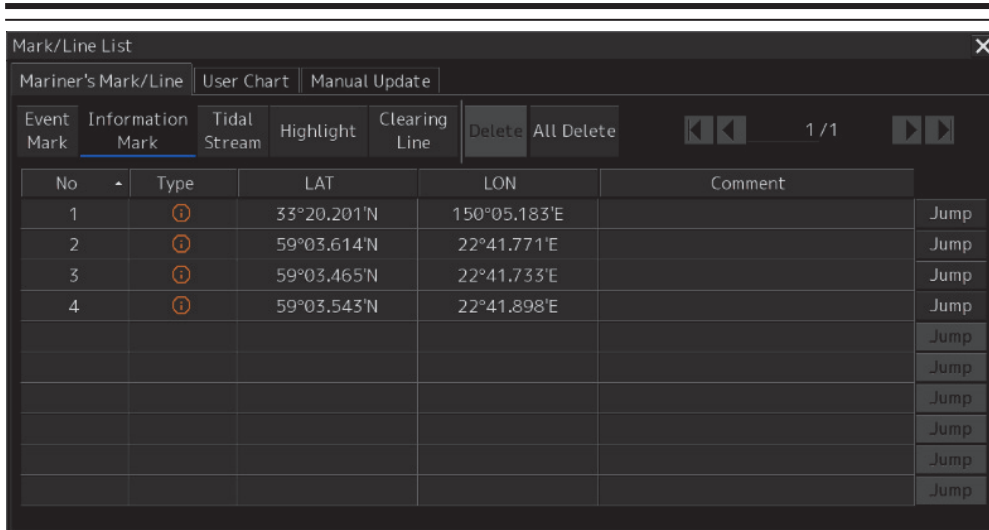

[Mariner's Mark/Line] tab (example at selection of [Information Mark])

12.7.3.1 Displaying an object on a chart

Click on the [Jump] button on the row of the object to be displayed on the chart.

12.7.3.2 Deleting an object

Select a line of the object to be deleted and click on the [Delete] button.

Note

As soon as the [Delete] button is clicked on, the object is deleted. Re-check whether the object can be deleted before clicking on the [Delete] button.

12.7.3.3 Deleting objects collectively from an object list

1 Click on the [All Delete] button.

A message dialog box for confirming deletion appears.

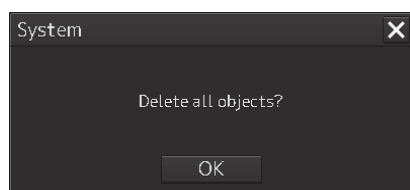

2 To execute deletion, click on the [OK] button. To cancel deletion, click on the [X] button.

12.8 Updating a Chart Manually (S-57/S-63)

Use the following procedure to update a chart.

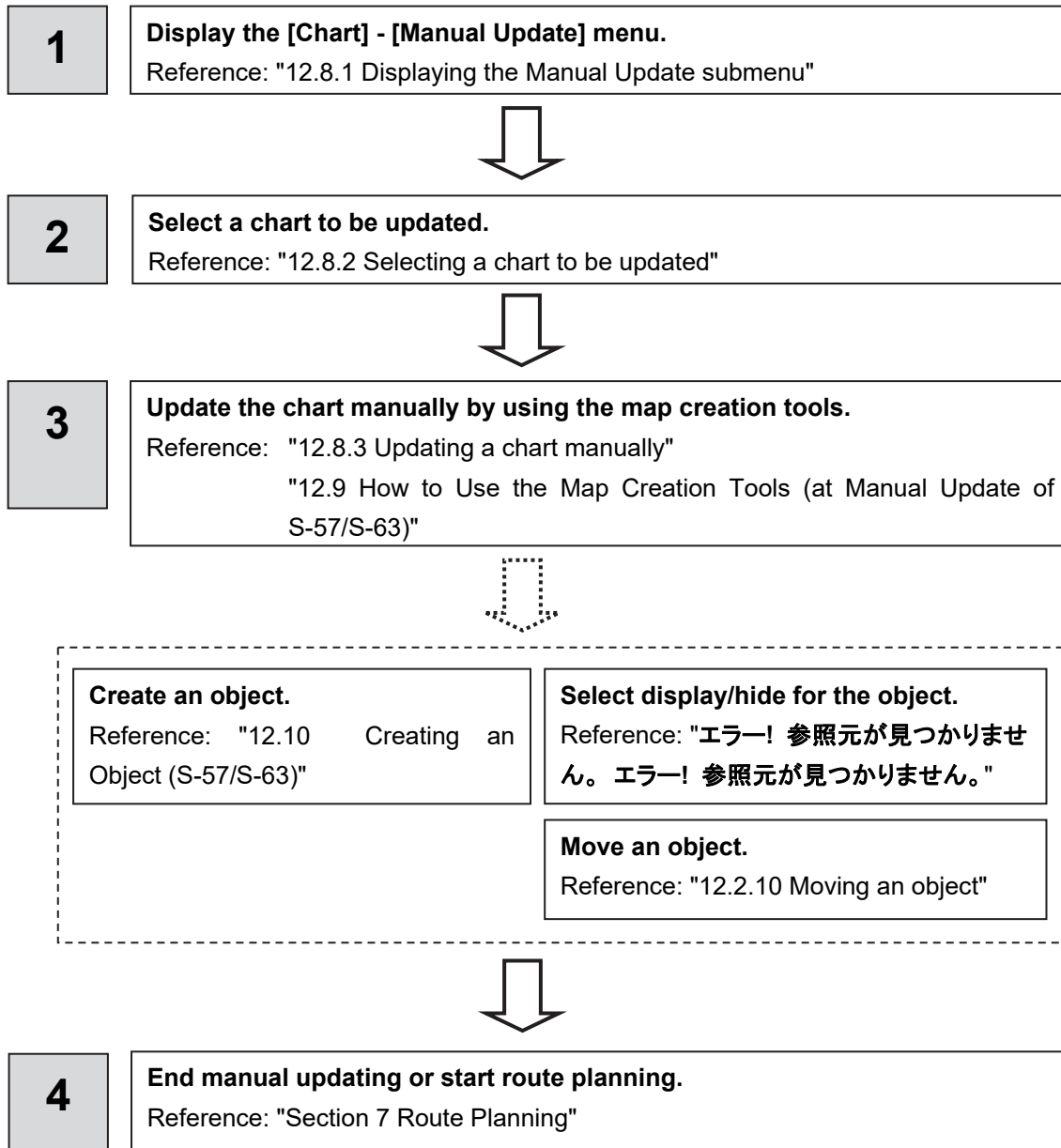

12.8.1 Displaying the Manual Update submenu

By selecting [Menu] - [Chart] - [Manual Update], the selected chart can be updated manually.

Restrictions

Multi-screen display is disabled at manual update of a chart. Even if multi-screen display is attempted prior to the commencement of manual update, the mode is switched to Single View if manual update is commenced.

Note:

- (1) In edit mode, the duration-dependent attribute is disabled temporarily. The objects that are hidden at the current time may be displayed.
- (2) Up to 100 objects can be edited from the start of editing to the saving of the editing by pressing the Save button.
- (3) Charts to be edited can be saved 50 times until they are updated.
- (4) When a chart to be edited is updated, all the manual updates up to then are hidden. The review is also disabled. The editing history can be checked by Update History of each chart.

Note:

- (1) While the manual update tool bar is active, the Chart Symbol setting is switched from "Simplified" to "Paper Chart" forcibly. When "Simplified" is selected before the Manual Update tool bar is displayed, the setting is reset to the original state after termination of the tool bar.
- (2) When the cursor is in AUTO mode, a manual update object can be edited only when the manual update tool bar is displayed and when the Manual Update tool bar is hidden, only the property screen display can be executed.

1. Click on the [Menu] button on the left toolbar.

The menu is displayed.

2. Click on the [Chart] button on the menu.

3. Click on the [Manual Update] button on the submenu.

The "Manual Update" toolbar is displayed.

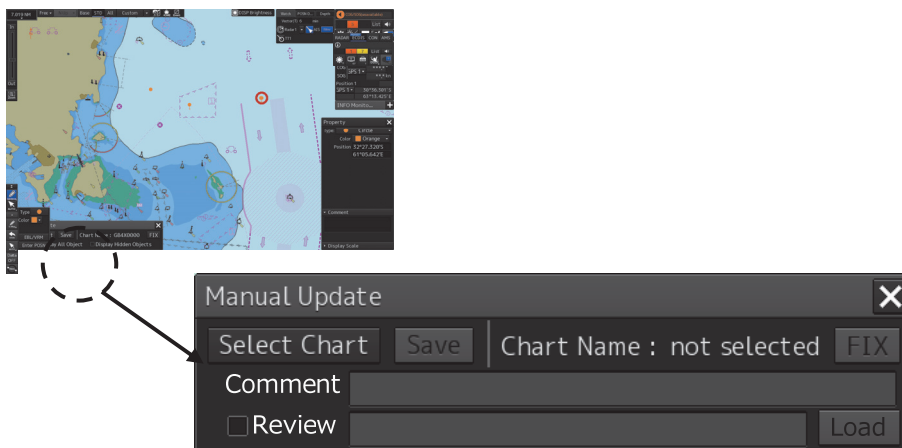

"Manual Update" toolbar

The following operations are available while the Manual Update tool bar is displayed.

| Editing item | Operation |
|--------------------------------|--|
| Manual update editing | Addition/editing of a manual update object |
| ENC object editing | Editing of the object on the chart |
| Attribute editing | Editing attributes |
| Remove function | Hiding an object (explicit save operation is necessary) |
| Delete function | Attaching a deletion symbol (explicit save operation is necessary) |
| Review function | Update history review function |
| Editing on the property screen | Editing on the property screen |

12.8.2 Selecting a chart to be updated

1. Click on the [Select Chart] button on the Manual Update toolbar.

The [Select Chart] dialog box appears.

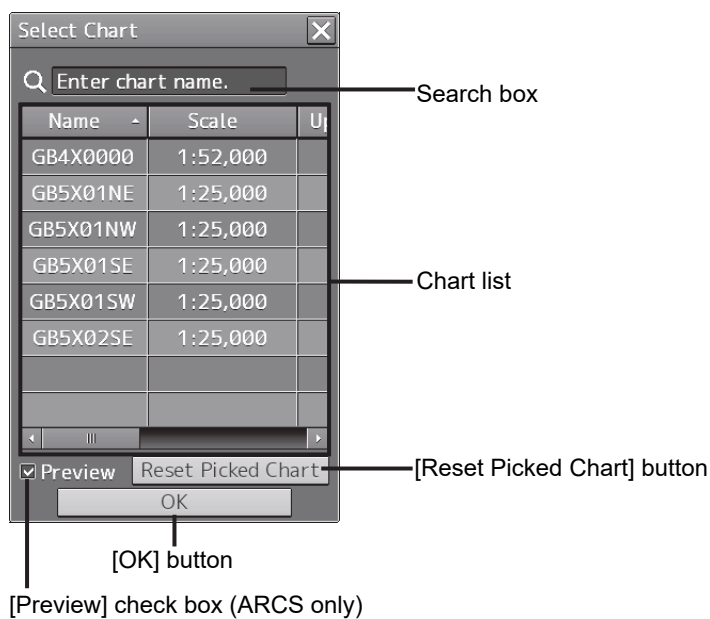

[Select Chart] dialog box

2. Select a chart file to be updated manually on the [Select Chart] dialog box.

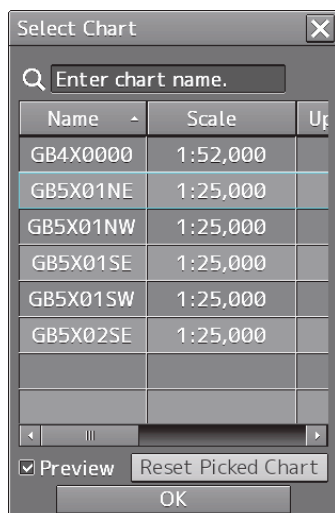

3. Click on the [OK] button in the [Select Chart] dialog box.

A chart is selected.

Memo

The information that is displayed in the chart list varies depending on the chart type.

The following information (columns of chart list) varies depending on the chart type.

○: Displayed

×: Not displayed

| Information (Columns of chart list) | Chart type |
|-------------------------------------|------------|
| | S-57 |
| Service | × |
| Issue Date | ○ |
| Ed. Date | × |
| Expiry | × |
| Last Update | ○ |
| Accepted | ○ |

12.8.2.1 Searching the position that is clicked on with the cursor

1. Move the cursor to the position where manual update is to be performed and click the button.

The chart that is drawn at the position that is selected by clicking is displayed in the chart list.

Memo

To clear the search result, click on the [Reset picked chart] (chart selection reset) button on the [Select Chart] dialog box. For C-MAP, all the charts in the database are displayed in the chart list.

12.8.2.2 Searching a chart with the chart name

1. Enter a chart name in the search box on the [Select Chart] dialog box.
The applicable chart is displayed.

Memo

To clear the search result, clear the input in the search box.

12.8.3 Updating a chart manually

1. Create/edit an object on the chart by using map creation tools.
(Refer to 12.9 How Use a Map Creation Tool (at Manual Update).)
2. Delete an object or change the properties as required.
(Refer to 12.10 Creating an Object.)

12.8.4 Displaying selected chart only

1. Select a chart to be displayed according the procedure that is described in “12.8.2 Selecting a chart to be updated”.
2. Set the [FIX] (fixing the chart) on the Manual Update tool bar to ON.



Memo

For the C-MAP chart or the ARCS chart, the [FIX] button cannot be set to ON.

12.8.5 Entering an editor of the manual update

Memo

The editor of the manual update can be recorded.

When the entry is saved, the text that has been entered in the Comment column is recorded in the editing history.

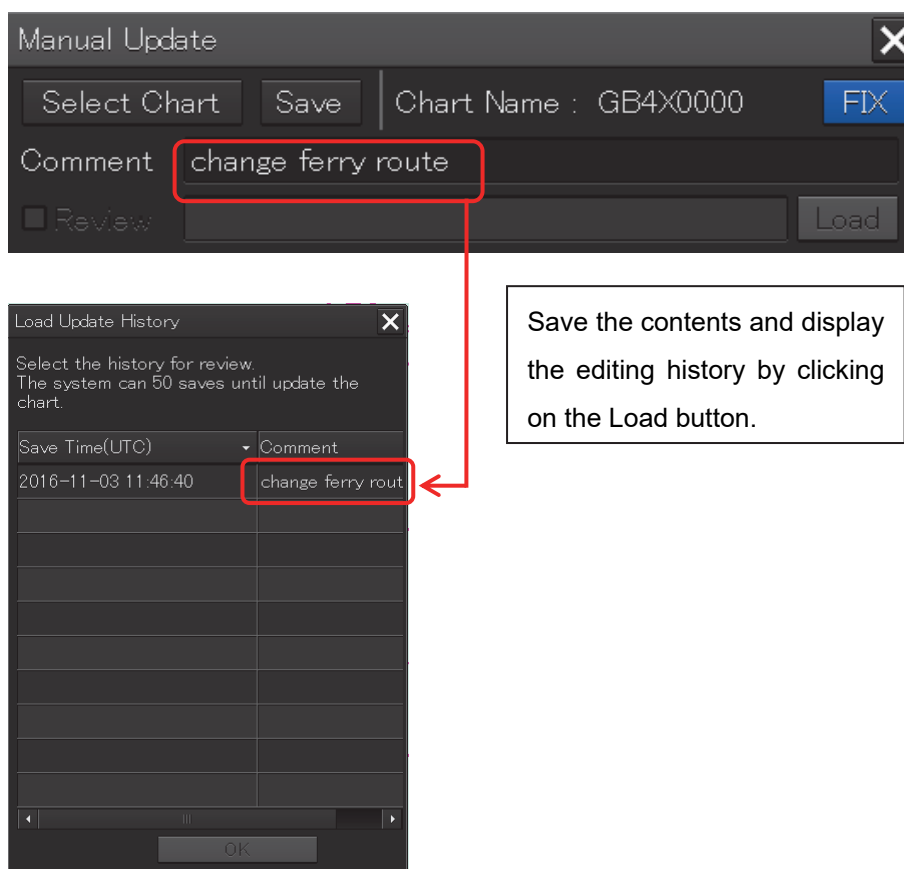

12.9 How to Use the Map Creation Tools (at Manual Update of S-57/S-63)

At chart manual update also, use the same map creation tools in the same way as that of user chart creation. (Refer to "12.2 Using Map Creation Tools (User Chart Creation/Editing)".) However, there are the following differences in the map creation tools

- The user chart information bar is not displayed.
- The object that is saved cannot be deleted by the eraser tool (can be hidden).
- A Mariner's Mark/Line drawing object cannot be selected with the drawing tool.
- More icon types can be selected in the drawing tool.

When the chart is updated manually, "Update" is displayed on the Write tool button.

Note

At chart manual update, the bearing reference mode is fixed to [N UP] mode.

12.9.1 Deleting or hiding an object

1. Click on the eraser tool button.

The cursor changes to the eraser cursor.



2. Place the eraser cursor on the object and click the button.

At manual update, only pre-saved objects can be deleted by the eraser tool.

If the saved object is clicked on with the eraser tool, the object is hidden. All the property screens of the object that has been set to hide are displayed as disable and cannot be edited.

The object that is created and saved by manual update can be redisplayed unless deleted even if it is hidden.

If the chart that uses the hidden object is updated, the expiration date of the object is set (90 days from the date on which the object is c).

The object will be deleted after the expiration date.

For the details, refer to "12.10.2 Object Delete function" and "12.10.3 Object Remove function".

Operations in eraser tool mode

| Mode | Target | Contents |
|-------------------------------------|--------------------------------|-------------------------------------|
| Manual Update tool bar is displayed | Object that has been saved | Remove the object |
| | Object that has not been saved | Cancel the object addition (erase). |
| Manual Update tool bar is hidden | Object that has been saved | No operation |

Note

The object that has been removed or deleted is excluded from the warning detection target.

12.9.2 Selecting an object type

1. Click on the [Type] button on the drawing toolbar.
An icon list dialog is displayed.
2. Select an object type by clicking on the icon on the icon list.
At manual update, the following icon list is displayed.

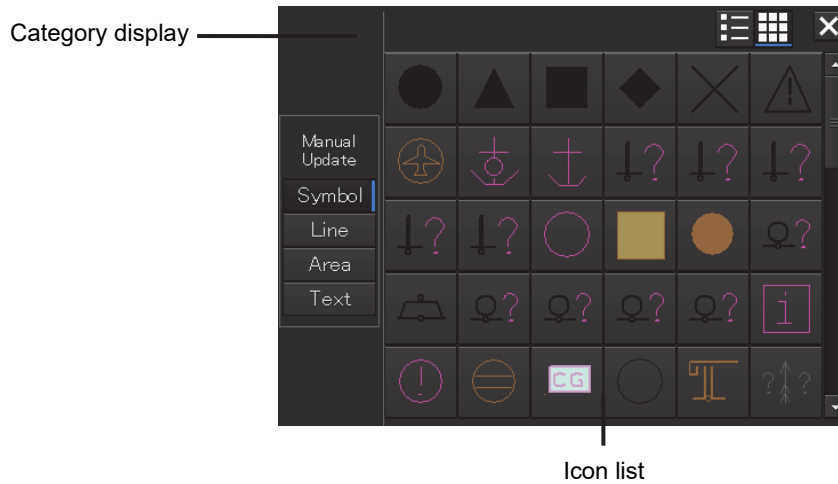

Icon list at manual update

The [Mariner's Mark/Line] button is not displayed on the icon list at manual update.
For the details of icons that can be selected from the icon list, refer to "Appendix B.6 Icon Button List for Manual Update".

12.10 Creating an Object (S-57/S-63)

This section describes the procedures for changing the parameters of the object after creating the object on the user chart or chart during manual update.

Note

After automatic sailing, the mark/line may be shifted depending on how the cursor is placed on the target at the input.

To prevent the shift, place the cursor on the front edge of the target.

16 Input method that does not cause shift (place the cursor on the front edge of the target)

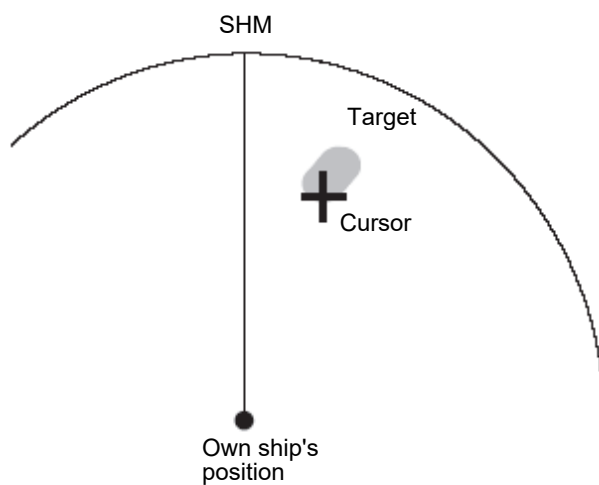

17 Input method that causes shift (place the cursor on the center of the target)

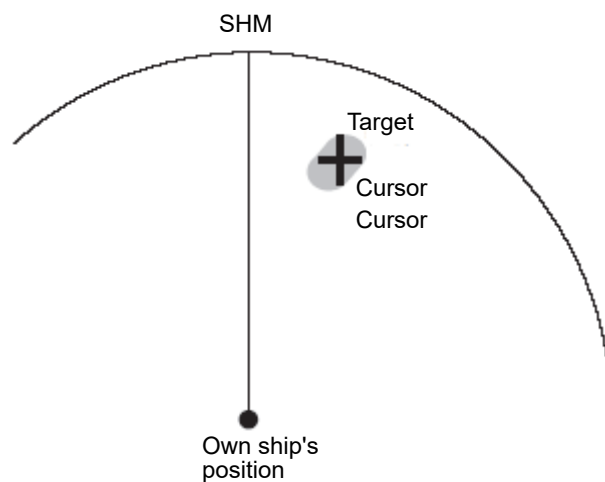

Note

Unlike the property screen at user chart editing, the manual update property screen does not have the Comment and Display Scale input columns.

12.10.1 Creating a symbol object (Symbol)

A symbol or a Warning symbol can be created by specifying the creation position with the cursor.

1. Click on the [Type] button on the drawing toolbar.

An icon list is opened.

Select a symbol or an icon of the Alerts symbol. (Refer to "12.2.3 Selecting an object type".)

2. Click on the position on which the symbol is to be created with the cursor.



The symbol is displayed on the position on which the button is clicked and the parameters of the symbol that was created are displayed on the object property dialog box.

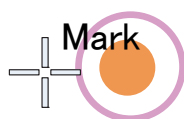

Latitude and longitude of the symbol creation position

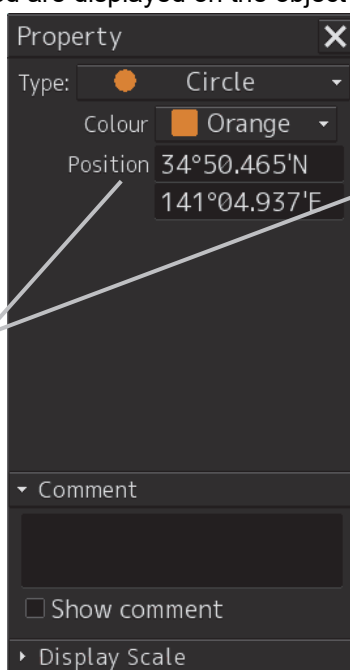

Non-ENC object



"Edit Attribute" button

ENC object

Note

For an ENC object, the screen can be switched to the attribute editing screen by using the [Edit Attribute] button.

For the details, refer to "12.10.9 Editing attributes of an object".

3. Adjust the parameters on the object property dialog box.

4. To create an object on another position continuously, repeat Steps 2 and 3.

12.10.1.1 Creating an object by specifying the latitude and longitude

1. Click on the [Enter POSN] button on the drawing toolbar.

The [Enter Position] dialog box appears (Refer to "12.2.6 Creating an object by specifying latitude and longitude).

2. Enter the latitude and longitude of the position on which an object is to be created and click on the [Enter] button.

An object is created on the specified latitude and longitude and the property information is reflected in the object property dialog box. (Refer to "12.2.8 Object property dialog box".)

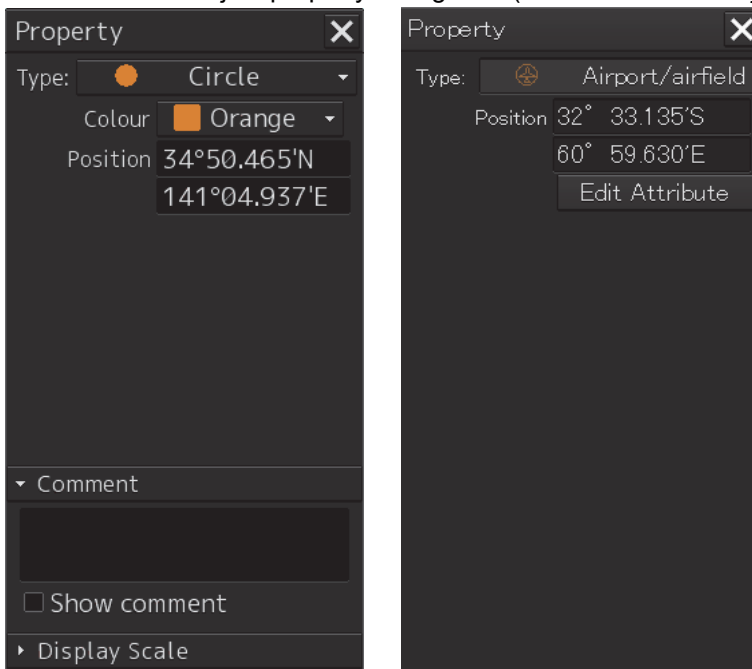

3. Adjust the parameters on the object property dialog box.
4. To create an object on another position continuously, repeat Steps 2 and 3.

12.10.1.2 Creating an object with EBL/VRM operation

1. Click on the [EBL/VRM] button on the drawing toolbar.

The cursor changes to the EBL/VRM reference point cursor. (Refer to "12.2.5 Creating an object in the EBL/VRM mode".)

2. Click on the position of the reference point of the EBL/VRM marker.

The EBL/VRM marker is displayed.

-
- 3. Place the EBL/VRM marker on the position on which the object is to be created and click the button.**

An object is created on the position on which the button was clicked and the property information is reflected in the object property dialog box. (Refer to "12.2.8 Object property dialog box".)

- 4. Adjust the parameters on the object property dialog box.**
- 5. To create an object on another position continuously, repeat Steps 2 to 4.**

12.10.2 Creating a simple line and Alerts line (Line object)

A simple line and Alerts line are created by using one vertex as an object. Alerts line is a line object that is detected as the warning target (danger line) of own ship.

Note

The color of Alerts line cannot be changed.

1. Click on the [Type] button on the drawing toolbar.

An icon list is opened.

Select an icon of a simple line or Alerts line. (Refer to "12.2.3 Selecting an object type".)

2. Click on the starting point with the cursor.

A vertex is created and the property information of the vertex is displayed on the object property dialog box.

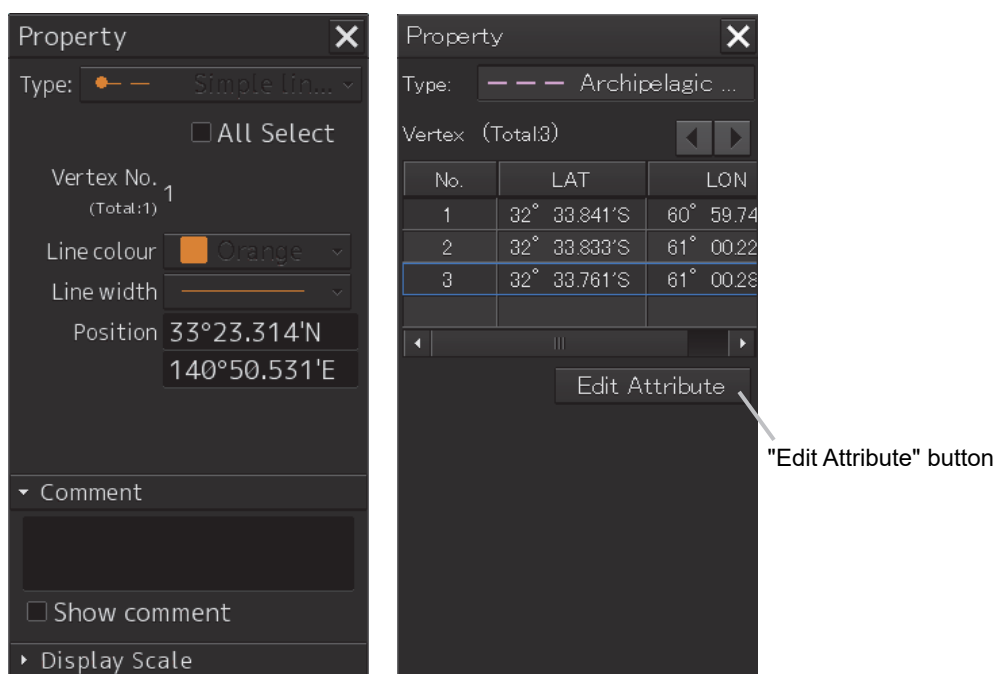

Note

For an ENC object, the screen can be switched to the attribute editing screen by using the [Edit Attribute] button.

For the details, refer to "12.10.9 Editing attributes of an object".

3. Move the cursor to the next vertex.

The latitude and longitude of the cursor are displayed near the cursor.

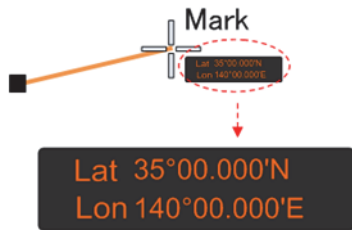

4. Click on the position on which the 2nd vertex is to be created.

A vertex is created and the parameters of the 2nd vertex are displayed on the object property dialog box.

Releasing the starting point selection state

Addition of 2nd point

Mark

The property screen is updated after the 2nd position is added.

Property

Type: Simple lin... [Type] becomes the medium point.

All Select

Vertex No. 2 (Total:2) The number of vertices becomes 2.

Line colour Orange Editing of the line colour and width is enabled.

Line width

Position 33°59.943'N 141°07.843'E The coordinates of the 2nd point are entered.

Comment

Show comment

Display Scale

5. Determine the line by double-click on the button or click the right button.

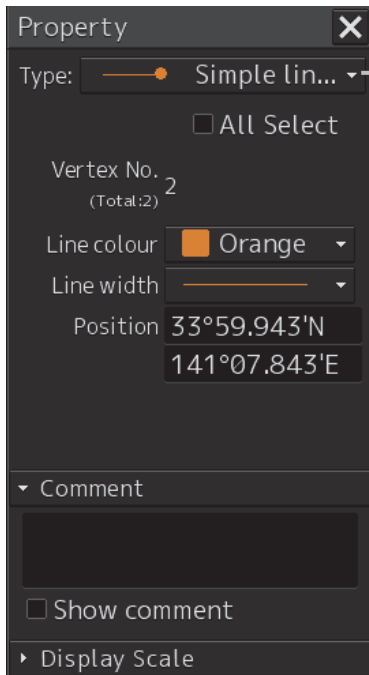
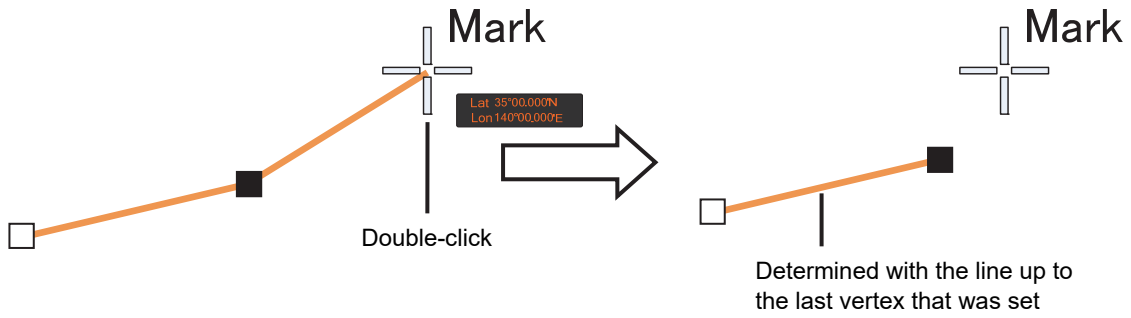

After determining of drawing, the last vertex changes to the end point.

6. Adjust the parameters on the object property dialog box.

7. To create an object on another position continuously, repeat Steps 2 to 6.

Memo

The property screen for the vertex that was created can be edited in AUTO mode. For the details of AUTO mode, refer to "3.13 Cursor AUTO Mode".

12.10.2.1 Creating a vertex by entering the position

- 1. Click on the [Enter POSN] button on the drawing toolbar.**
The [Enter Position] dialog box appears.
- 2. Enter the latitude and longitude of the vertex of the object in the [Position] box and click on the [Enter] button.**
The position of the vertex of the object is determined.
The [Bearing] box and the [Distance] box are enabled.
- 3. Enter the values of the latitude and the longitude of the next vertex in the [Position] box. Alternatively, enter the bearing from the vertex that was determined immediately previously in the [Bearing] box and the [Distance] input box.**
- 4. Click on the [Enter] button.**
- 5. Determine the positions of 3 or more vertices by repeating Steps 2 and 3.**
- 6. Adjust the parameters on the object property dialog box.**
- 7. To create an object in another position continuously, click on the [New] button of the [Enter Position] dialog and repeat Steps from 2 to 6.**

12.10.2.2 Creating an object with EBL/VRM operation

- 1. Click on the [EBL/VRM] button on the drawing toolbar.**
The cursor changes to the EBL/VRM reference point cursor. (Refer to "12.2.5 Creating an object in the EBL/VRM mode".)
- 2. Click on the position of the reference point of the EBL/VRM marker.**
The EBL/VRM marker is displayed.
- 3. Place the EBL/VRM marker on the starting point and click the button.**
A vertex is created on the position on which the button was clicked and the information is reflected in the object property dialog box. (Refer to "12.2.8 Object property dialog box".)

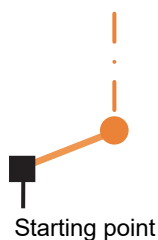

- 4. Click on the position of the reference point.**
The EBL/VRM marker that determines the 2nd point is displayed.

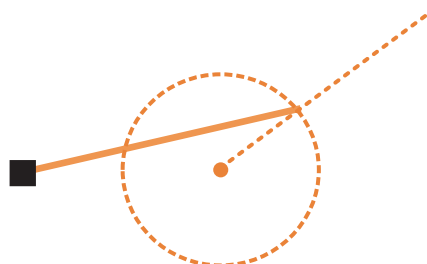

5. Place the EBL/VRM marker on the 2nd vertex and click the button.

A vertex is created on the position on which the button was clicked and the information is reflected in the object property dialog box. (Refer to "12.2.8 Object property dialog box".)

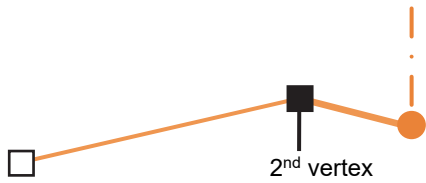

The EBL/VRM marker is reset to the EBL/VRM reference point cursor.

6. Adjust the parameters on the object property dialog box.

7. To create an object on another position continuously, repeat Steps 2 to 6.

12.10.3 Creating a circle, ellipse, and an arc (Line object)

A circle, an ellipse, and arc can be drawn with the cursor by specifying the center.

1. Click on the [Type] button on the drawing toolbar.

An icon list is opened.

2. Select an icon of a circle, an ellipse, or an arc.

(Refer to "12.2.3 Selecting an object type".)

3. Click on the position for the center with the cursor.

The center is created and the property information on the vertex is displayed on the object property dialog box.

Property ✕

Type: Circle(sol... ▾

Line colour Orange ▾

Line width ▾

Center point 35°06.805'N
 141°42.247'E

Radius 10.00 NM

▼ Comment

Show comment

▸ Display Scale

Property ✕

Type: Ellipse(so... ▾

Line colour Orange ▾

Line width ▾

Center point 34°46.820'N
 142°02.687'E

Horizontal 0.17 NM

Vertical 0.07 NM

▼ Comment

Show comment

▸ Display Scale

Property ✕

Type: Arc(solid ... ▾

Line colour Orange ▾

Line width ▾

Center point 34°45.340'N
 142°00.243'E

Radius 0.12 NM

Start angle 000 °

End angle 090 °

▼ Comment

Show comment

▸ Display Scale

4. Draw a circle, an ellipse, or an arc.

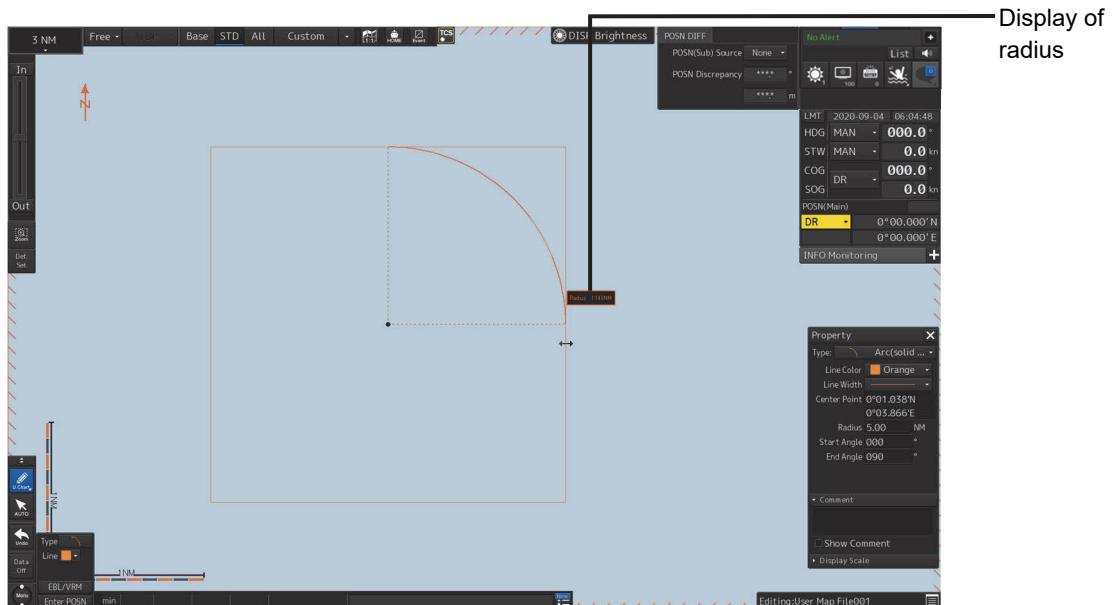
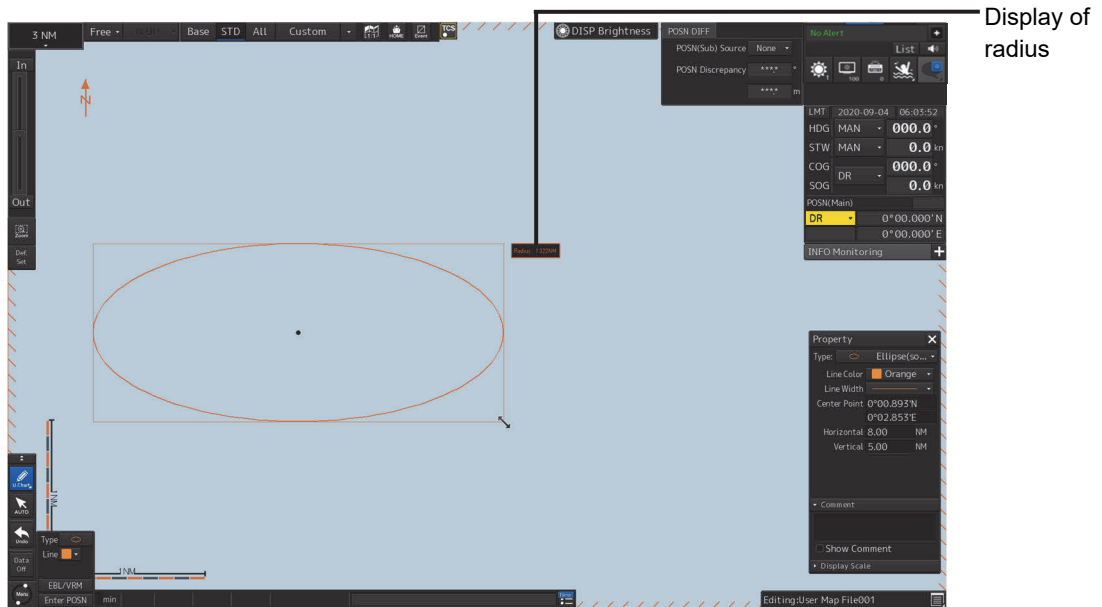
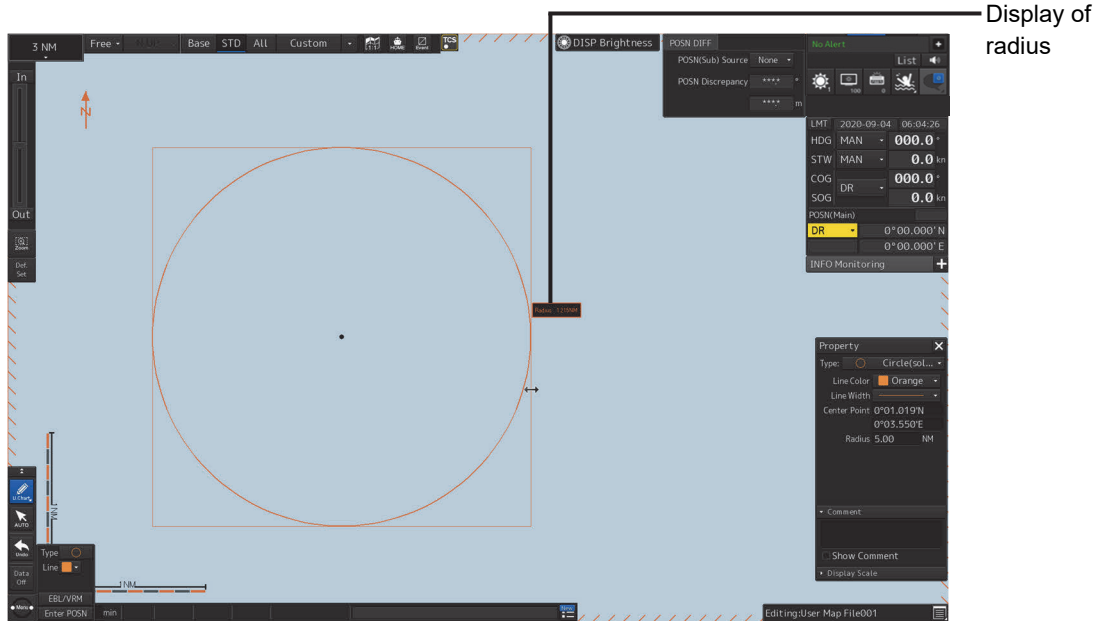

At creation of an arc, the starting angle and the ending angle of the arc to be created are the previous values or the initial values (starting angle: 0°, ending angle: 90°). To change the starting angle and the ending angle, change the values in [Start Angle] and [End Angle] on the object property dialog box.

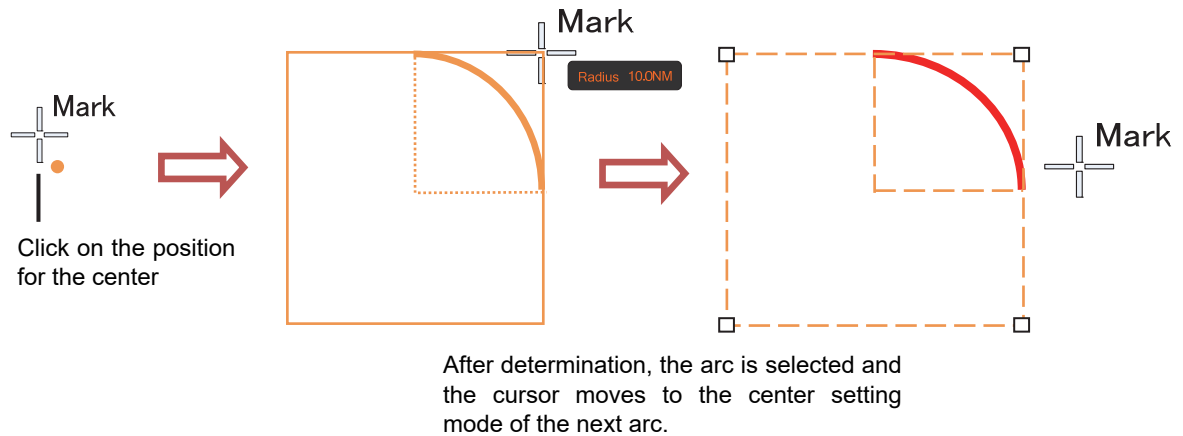

5. Determine the object by clicking the button again.
6. Adjust the parameters on the object property dialog box.
7. To create an object on another position continuously, repeat Steps 3 to 6.

12.10.3.1 Creating an object by specifying a position for the center and size of the object

1. Click on the [Enter POSN] button on the drawing toolbar.
The [Enter Position] dialog box appears. (Refer to "12.2.6 Creating an object by specifying latitude and longitude".)
2. Enter the coordinate of the center of the circle, ellipse, or arc and click on the [Enter] button of the [Enter Position] dialog box.
The center is created at the position of the specified coordinate and the property information is reflected in the object property dialog box. (Refer to "12.2.8 Object property dialog box".)
3. Set the parameters in the object property dialog box as indicated below.
 - Circle: Enter a value of [Radius].
 - Ellipse: Enter values of [Horizontal] and [Vertical].
 - Arc: Enter values of [Radius], [Start Angle], and [End Angle].
4. To create an object on another position continuously as required, repeat Steps 2 and 3.

12.10.4 Creating a polygon and Alerts area (Area object)

Create a polygon using all the vertices (3 or more) as one object. Alerts area is an area object that is detected as a warning target (danger area).

A polygon and a Alerts area can be created in the same way as for simple line and Alerts line

1. Click on the [Type] button on the drawing toolbar.

An icon list is opened.

Select an icon of a polygon or a Alerts area. (Refer to "12.2.3 Selecting an object type".)

2. Click on the starting point position with the cursor.

The starting point is created and the property information of vertex 1 is displayed on the object property dialog box.

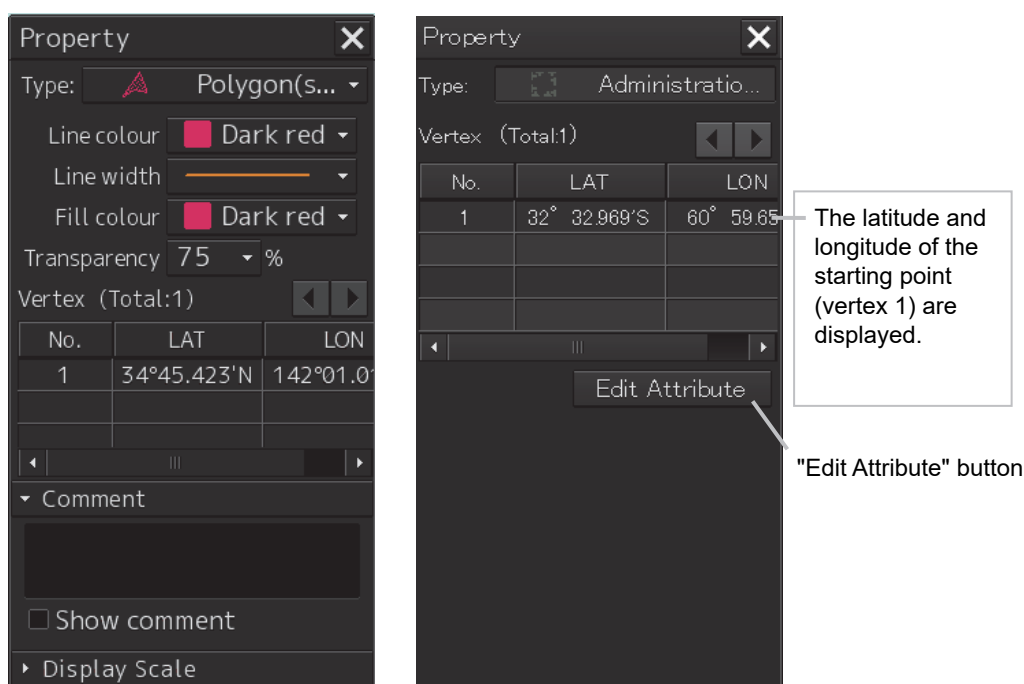

Note

For an ENC object, the screen can be switched to the attribute editing screen by using the [Edit Attribute] button.

For the details, refer to "12.10.9 Editing attributes of an object".

3. Move the cursor to the next vertex.

The latitude and longitude of the cursor are displayed near the cursor.



4. Click on the position on which the 2nd vertex is to be created.

A vertex is created and the latitude and the longitude of the 2nd vertex are displayed on the object property dialog box

Resetting the starting point selection state

Add the 2nd point

Mark

Property

Type: Polygon(s...)

Line colour: Dark red

Line width: [Slider]

Fill colour: Dark red

Transparency: 75 %

Vertex (Total:2)

| No. | LAT | LON |
|-----|-------------|------------|
| 1 | 34°45.423'N | 142°01.0' |
| 2 | 34°45.612'N | 142°01.30' |

Editing of the line color and width is enabled.

Editing of the line color and width is enabled.

The number of vertices becomes 2.

The coordinates of the 2nd point are entered.

5. Click on the position on which the 3rd vertex is to be created.

A triangle is created by connecting the three vertices. A preview screen is displayed, enabling the checking of the fill statuses of the polygon and the Alerts area.

The preview of the result of filling the area is displayed.

The latitude and longitude of the 3rd vertex are displayed on the object property dialog box.

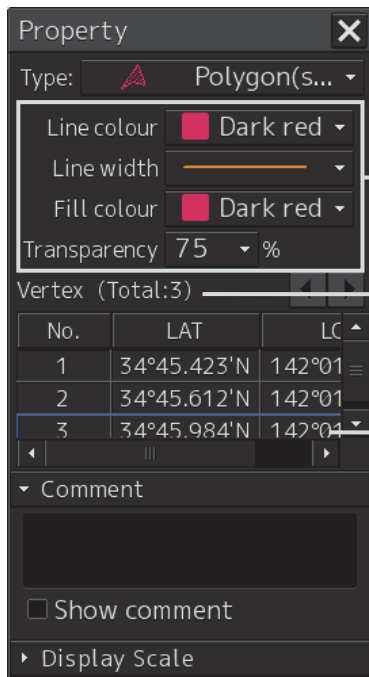

The editing of the line color, line width, fill color, and transparency is enabled.

The number of vertices becomes 3.

The coordinates of the 3rd vertex are entered.

- To add another vertex continuously, click on the position on which the vertex is to be created.

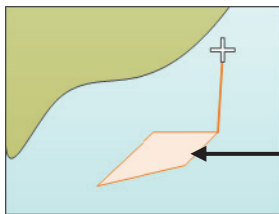

When the 4th vertex is determined, the preview display is updated.

When not adding any further vertices, determine the polygon or the Alerts area by double-clicking the button or clicking the right button.

- Adjust the parameters on the object property dialog box.
- To create an object on another position continuously, repeat Steps 2 to 7.

12.10.4.1 Creating a vertex by entering the position

- Click on the [Enter POSN] button on the drawing toolbar.
The [Enter Position] dialog box appears.
- Enter the latitude and longitude of the vertex of the object in the [Position] box and click on the [Enter] button.
The position of one vertex of the object is determined.
The [Bearing] box and the [Distance] box are enabled.
- Enter the values of the latitude and the longitude of the next vertex in the [Position] box. Alternatively, enter the bearing from the vertex that was determined immediately previously in the [Bearing] box and the [Distance] input box.
- Click on the [Enter] button.
- Determine 3 or more vertices by repeating Steps 2 to 4.

6. Adjust the parameters on the object property dialog box.
7. To create an object on another position continuously, repeat Steps 2 to 6.

12.10.4.2 Creating an object with EBL/VRM operation

1. Click on the [EBL/VRM] button on the drawing toolbar.
The cursor changes to the EBL/VRM reference point cursor. (Refer to "12.2.5 Creating an object in the EBL/VRM mode".)
2. Click on the position of the reference point of the EBL/VRM marker.
The EBL/VRM marker is displayed.
3. Place the EBL/VRM marker on the starting position and click the mouse button.
A vertex is created on the position on which the button was clicked and the parameter information is reflected on the object property dialog box. (Refer to "12.2.8 Object property dialog box".)

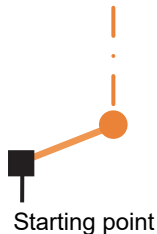

4. Click on the position of the reference point.
The EBL/VRM marker that determines the 2nd vertex is displayed.

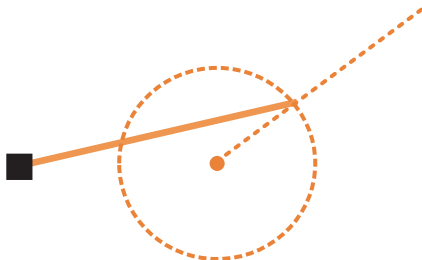

5. Place the EBL/VRM marker on the 2nd vertex position and click the button.
A vertex is created on the position on which the button was clicked and the property information is reflected in the object property dialog box. (Refer to "12.2.8 Object property dialog box".)

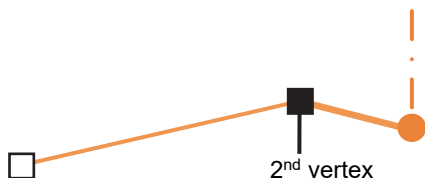

The EBL/VRM marker is reset to the EBL/VRM reference point cursor.

6. Place the EBL/VRM marker on the position of the 3rd vertex and click the button.

A triangle is created by connecting the three vertices. The preview screen is displayed, enabling the checking of the fill state of the polygon and Alerts area.

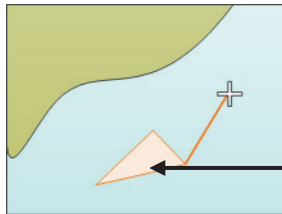

Preview of the area fill result is displayed.

7. Adjust the parameters on the object property dialog box.

8. To create an object on another position continuously, repeat Steps 1 to 7.

12.10.5 Creating circle, ellipse, and fan areas (Area object)

Circle, ellipse, and fan areas can be created in the same way as for creating a circle, an ellipse, or an arc of the Line object.

1. Click on the [Type] button on the drawing toolbar.

An icon list is opened.

2. Select an icon of circle, ellipse, or arc. (Refer to "12.2.3 Selecting an object type".)

3. Click on the position to be the center with the cursor.

A center is created and the vertex property information is displayed on the object property dialog box.

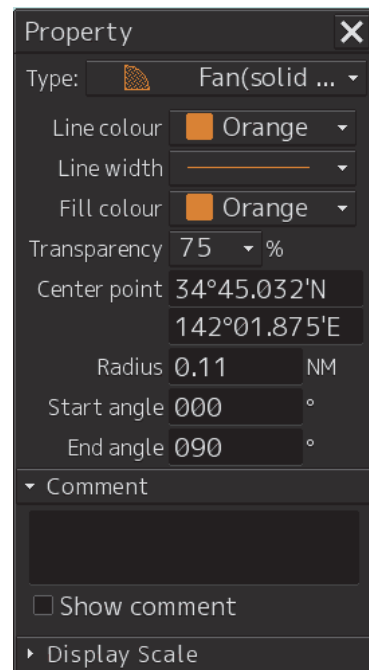
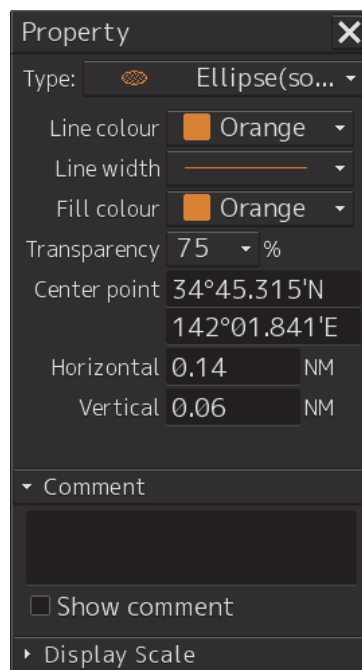
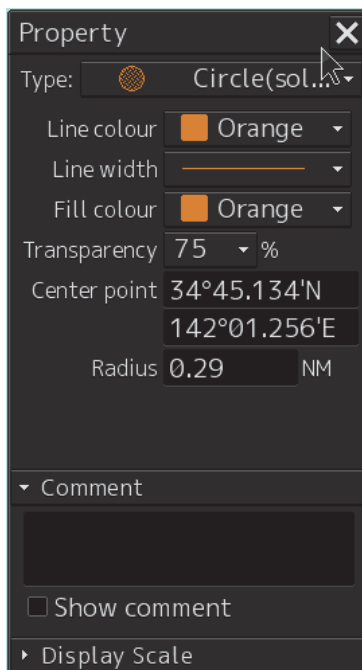

4. Draw a circle, an ellipse, and an arc.

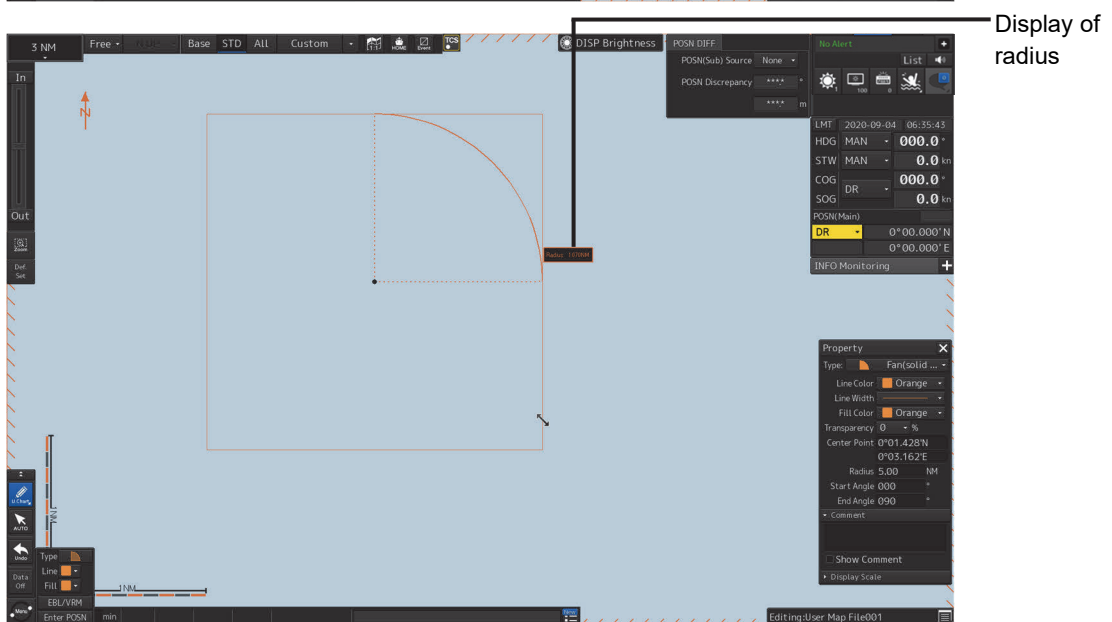
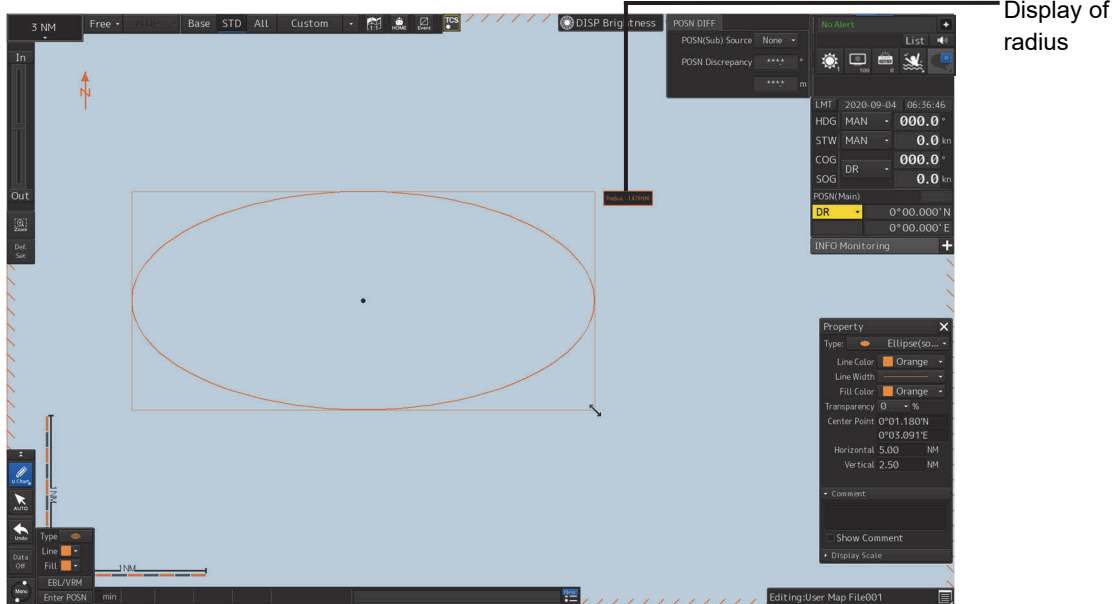
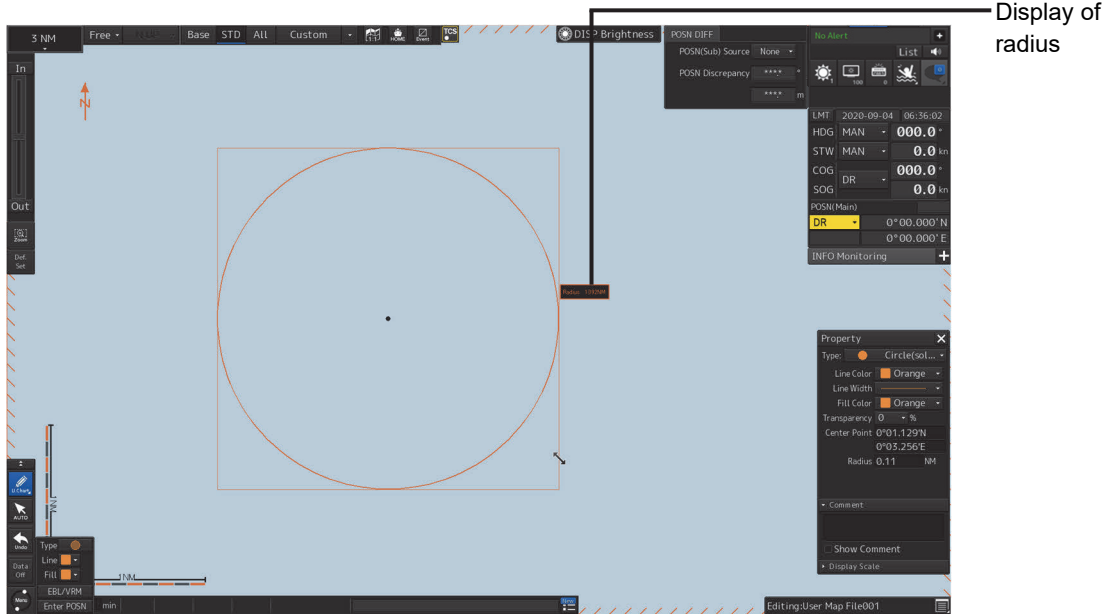

At creation of an arc, the starting angle and the ending angle of the arc to be created are the previous values or the initial values (starting angle: 0°, ending angle: 90°). To change the starting angle and the ending angle, change the values in [Start Angle] and [End Angle] on the object property dialog box.

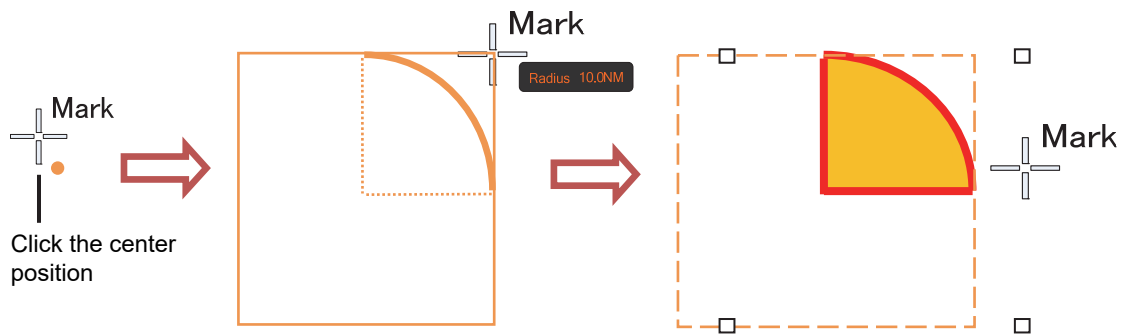

After determination, the arc is selected and the cursor moves to the center setting mode for the next arc.

5. Determine the object by clicking the button again.
6. Adjust the parameters on the object property dialog box.
7. To create an object on another position continuously, repeat Steps 3 to 6.

12.10.5.1 Creating an object by specifying the center position and the object size

1. Click on the [Enter POSN] button on the drawing toolbar.
The [Enter Position] dialog box appears (Refer to "12.2.6 Creating an object by specifying latitude and longitude".)
2. Enter the coordinates of the center of the circle, ellipse, or arc and click on the [Enter] button on the [Enter Position] dialog box.
A center point is created on the position of the specified coordinates and the property information is reflected in the object property dialog box (Refer to "12.2.8 Object property dialog box".)
3. Set the following parameters on the object property dialog box.
 - Circle: Enter a value of [Radius].
 - Ellipse: Enter values of [Horizontal] and [Vertical].
 - Arc: Enter values of [Radius], [Start Angle], and [End Angle].
4. To create an object on another position continuously as required, repeat Steps 2 and 3.

12.10.6 Creating a text (Text object)

Any character information can be displayed on the user chart.

1. Click on the [Type] button on the drawing toolbar.

An icon list is opened.

Select a text (Txt) icon. (Refer to "12.2.3 Selecting an object type".)

2. With the cursor, click on the position on which an object is to be created.



A text box is created at the position on which the button was clicked and a text is displayed.



The parameters of the text that was created are displayed on the object property dialog box.

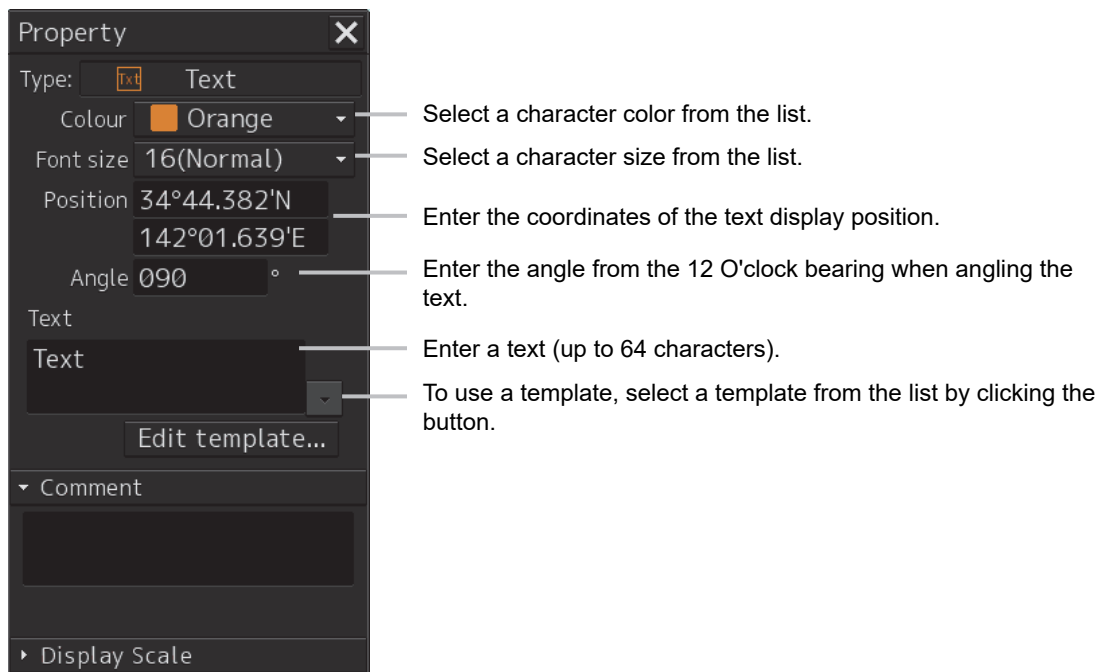

3. Adjust the parameters on the object property dialog box.

For the text input method, refer to "12.10.6.3 Editing a text", for the template usage method, refer to "12.10.6.4 Editing a template", and for the text angling method, refer to "12.10.6.5 Changing a text angle".

4. To create an object on another position continuously, repeat Steps 2 and 3.

12.10.6.1 Creating a text by specifying the latitude and longitude

1. Click on the [Enter POSN] button on the drawing toolbar.

The [Enter Position] dialog box appears (Refer to "12.2.6 Creating an object by specifying latitude and longitude".)

2. Enter the latitude and longitude of the object to be created and click on the [Enter] button.

An object is created on the specified latitude and longitude and the property information is reflected in the object property dialog box. (Refer to "12.2.8 Object property dialog box".)

3. Adjust the parameters on the object property dialog box.

For the text input method, refer to "12.5.6.3 Editing a text", for the template usage method, refer to "12.5.6.4 Editing a template", and for the text angling method, refer to "12.5.6.5 Changing a text angle".

4. To create an object on another position continuously, repeat steps 2 and 3.

12.10.6.2 Creating a text with EBL/VRM operation

1. Click on the [EBL/VRM] button on the drawing toolbar.

The cursor changes to the EBL/VRM reference point cursor. (Refer to "12.2.5 Creating an object in the EBL/VRM mode".)

2. Click on the position of the reference point position of the EBL/VRM marker.

The EBL/VRM marker is displayed.

3. Place the EBL/VRM marker on the position on which an object is to be created and click the button.

An object is created on the position on which the button was clicked and the property information is reflected in the object property dialog box. (Refer to "12.2.8 Object property dialog box".)

4. Adjust the parameters on the object property dialog box.

For the text input method, refer to "12.10.6.312.10.6.3 Editing a text", for the template usage method, refer to "12.10.6.4 Editing a template", and for the text angling method, refer to "12.10.6.5 Changing a text angle".

5. To create an object on another position continuously, repeat Steps 2 to 4.

12.10.6.3 Editing a text

1. Click on the [Text] input box

A character input full keyboard is displayed.

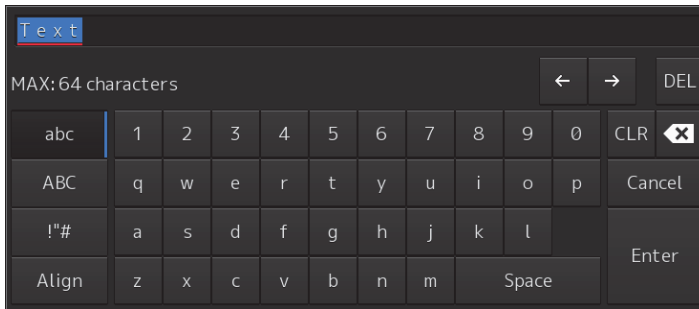

2. Create a text.

For the method of using the character input full keyboard, refer to "3.16.2 Name and function of each section of the keyboard".

3. Close the character input full keyboard by clicking on the [Enter] key.

4. To change a character color, select a required character color from the [Color] combo box.

5. To change a character size, select a required character size from the [Font size] combo box.

12.10.6.4 Editing a template

By registering a frequently used text as a template, the template can be used at text creation.

1. Click on the [Edit Template] button.

The [Template] dialog box appears.

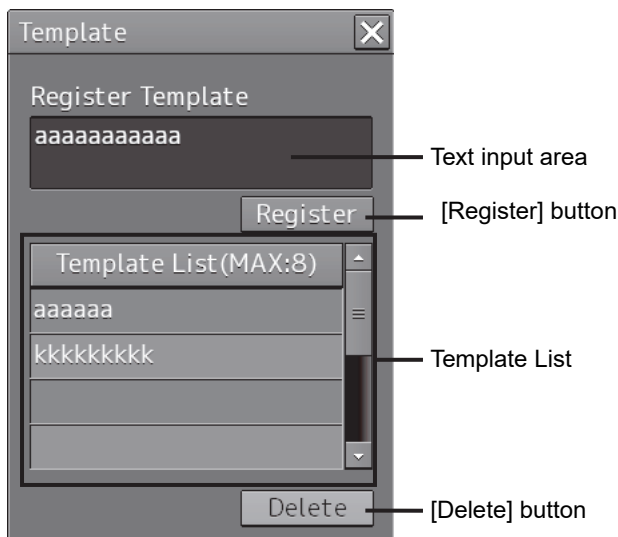

2. Click on a text input area.

A character input full keyboard is displayed.

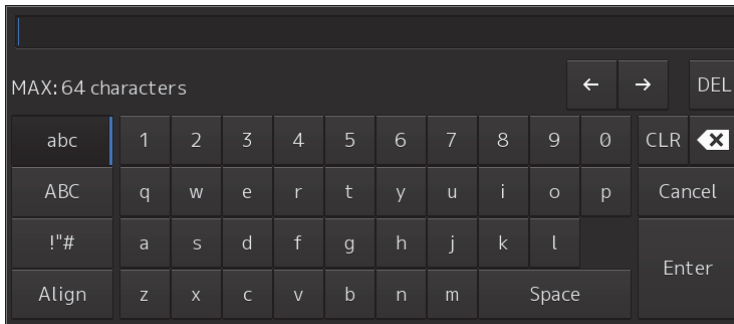

3. Create a text.

For the method of using the character input full keyboard, refer to "3.16.2 Name and function of each section of the keyboard".

4. Close the character input full keyboard by clicking on the [Enter] key.

5. Click on the [Register] button.

6. Close the [Template] dialog and click on [▼] on the right side of the text input area of the object properties dialog.

[Template List] is displayed.

7. Select any template.

8. To delete unnecessary templates, select the unnecessary templates in the [Template List] and click on the [Delete] button.

12.10.6.5 Changing a text angle

Under the factory setting, a text is oriented horizontally. The text can be angled or inverted according to the text creation position.

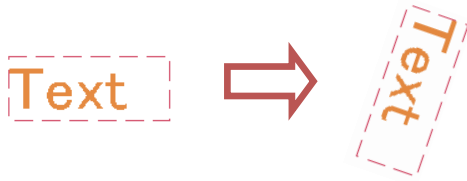

1. Click on the [Angle] input box.

A numeric value input keyboard is displayed.

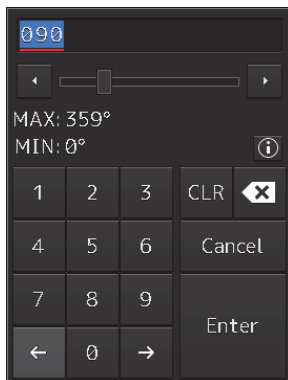

2. Enter an angle.

Specify an angle in clockwise based on the direction of the 12 O'clock as 0°. Under the factory setting, the angle is set to 90° (horizontal).

For the method of using the numeric value input keyboard, refer to "3.16.2 Name and function of each section of the keyboard".

12.10.7 Creating an arrow (Line object)

An arrow can be displayed on the user chart or chart.

1. Click on the [Type] button on the drawing toolbar.

An icon list is displayed.

2. Select the arrow icon. (Refer to "12.2.3 Selecting an object type".)

3. Click on the starting position with the cursor.

A starting point is created and the property information of the starting point is displayed on the object property dialog box.

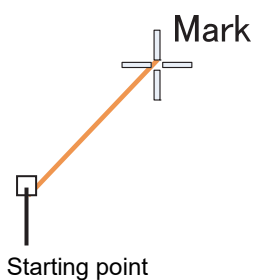

| Property | |
|---------------------------------------|-----------------------------|
| Type: | Arrow(St... ▾ |
| Line colour | Orange ▾ |
| Line width | ▾ |
| Start point | 34°44.120'N 142°01.531'E |
| End point | 35°20.818'N 141°33.118'E |
| ▾ Comment | |
| <input type="checkbox"/> Show comment | |
| ▸ Display Scale | |

Latitude and longitude of starting point

Note

The color, line type, and line width of a starting point cannot be changed.

4. Click on the position of the ending point with the cursor.

An ending point is created and the property information of the ending point is displayed on the object property dialog box.

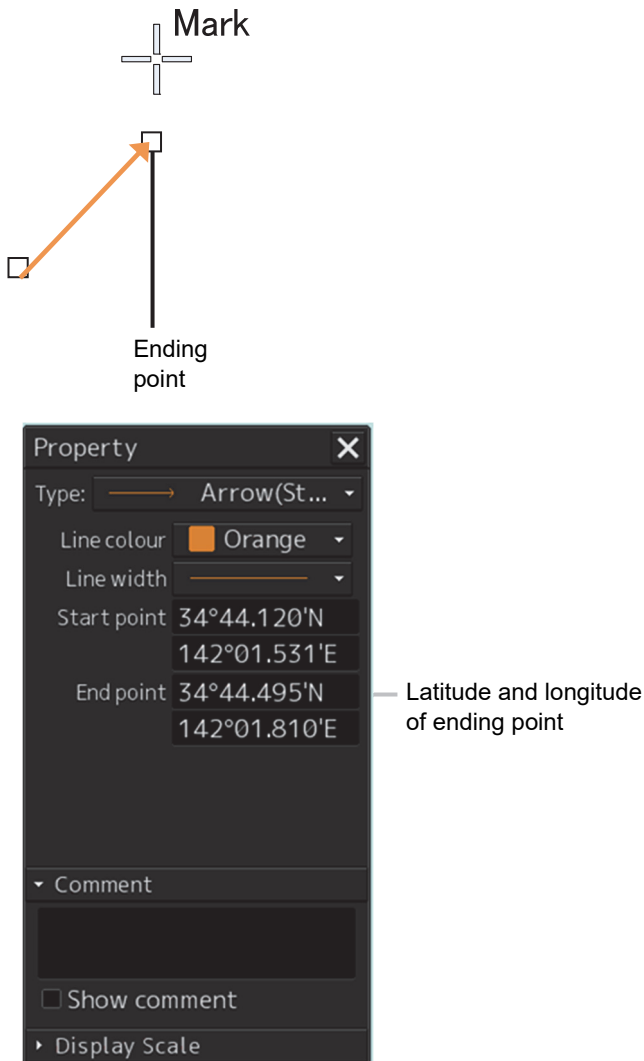

5. Adjust the parameters on the object property dialog box.

6. To create an object on another position continuously, repeat Steps to 3 to 5.

12.10.7.1 Creating an object by specifying the starting point/ending point position coordinates

1. Click on the [Enter POSN] button on the drawing toolbar.

The [Enter Position] dialog box appears (Refer to "12.2.6 Creating an object by specifying latitude and longitude".)

2. Enter the coordinates of the starting point and click on the [Enter] button.

A starting point of the arrow is created on the position of the specified coordinates and the property information is reflected in the object property dialog box. (Refer to "12.2.8 Object property dialog box".)

3. Enter the coordinates of the ending point and click on the [Enter] button.

An ending point of the arrow is created on the position of the specified coordinates and the property information is reflected in the object property dialog box.

4. To create an object on another position continuously, repeat Steps 1 to 3.

12.10.7.2 Drawing an object with EBL/VRM operation

1. Click on the [EBL/VRM] button on the drawing toolbar.

The cursor changes to the EBL/VRM reference point cursor. (Refer to "12.2.5 Creating an object in the EBL/VRM mode".)

2. Click on the position of the reference point of the EBL/VRM marker.

The EBL/VRM marker is displayed.

3. Place the EBL/VRM marker on the position of the starting point and click the button.

4. Click on the reference position of the EBL/VRM marker.

A starting point is created on the position on which the button was clicked and the property information is displayed on the object property dialog box. (Refer to "12.2.8 Object property dialog box".)

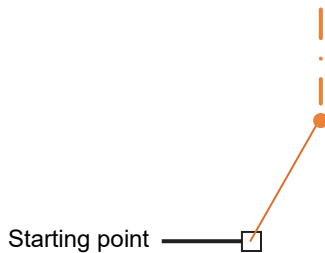

5. Place the EBL/VRM marker on the position of the ending point and click the button.

An ending point is created on the position on which the button was clicked and the property information is displayed on the object property dialog box. (Refer to "12.2.8 Object property dialog box".)

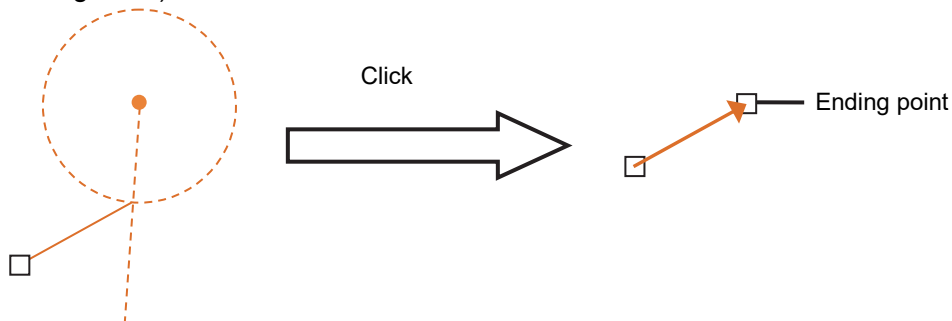

6. To create an object on another position continuously, repeat Steps 2 to 5.

12.10.8 Property of a Sounding object

Only a Sounding object has the Property screen different from other objects, enabling input of a Sounding value.

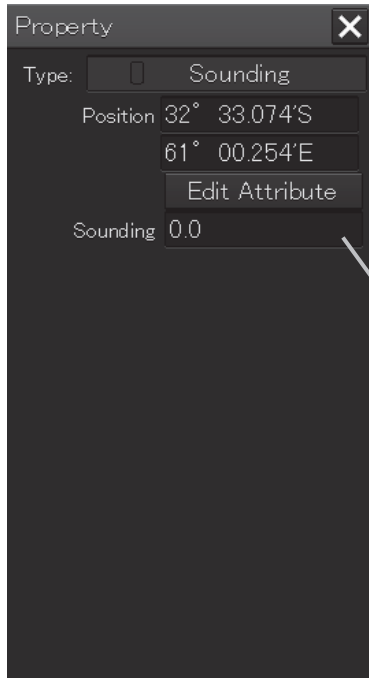

The screenshot shows a 'Property' dialog box with a close button (X) in the top right corner. The dialog contains the following fields and controls:

- Type: Sounding
- Position: 32° 33.074'S
- 61° 00.254'E
- Edit Attribute button
- Sounding: 0.0

An arrow points from the text 'Sounding value input box' to the 'Sounding' field.

Sounding value input box

12.10.9 Editing attributes of an object

The attribute input rules of the ENC object that is handled by manual update are specified in “S-57 Appendix A Chapter 2 – Attributes”. The following six types of ENC object attributes are available.

| Attribute type | |
|-------------------|---|
| enumerated('E') | One of the options can be selected. |
| list('L') | Although the attribute is the same as enumerated, multiple options can be selected. |
| float('F') | A decimal digit can be input. |
| integer('I') | An integer can be input. |
| coded string('A') | Free text |
| free text('S') | Free text |

To display an object correctly at manual update, the attributes must be input as described in “S-57 Appendix A Chapter 2 – Attributes”.

For types ‘E’, ‘L’, ‘F’, and ‘I’, options and input ranges are displayed in the input dialog. For types ‘A’ and ‘S’, enter values according to the rules by referencing “B.6.5 Attributes of an ENC object”.

12.10.9.1 Type E

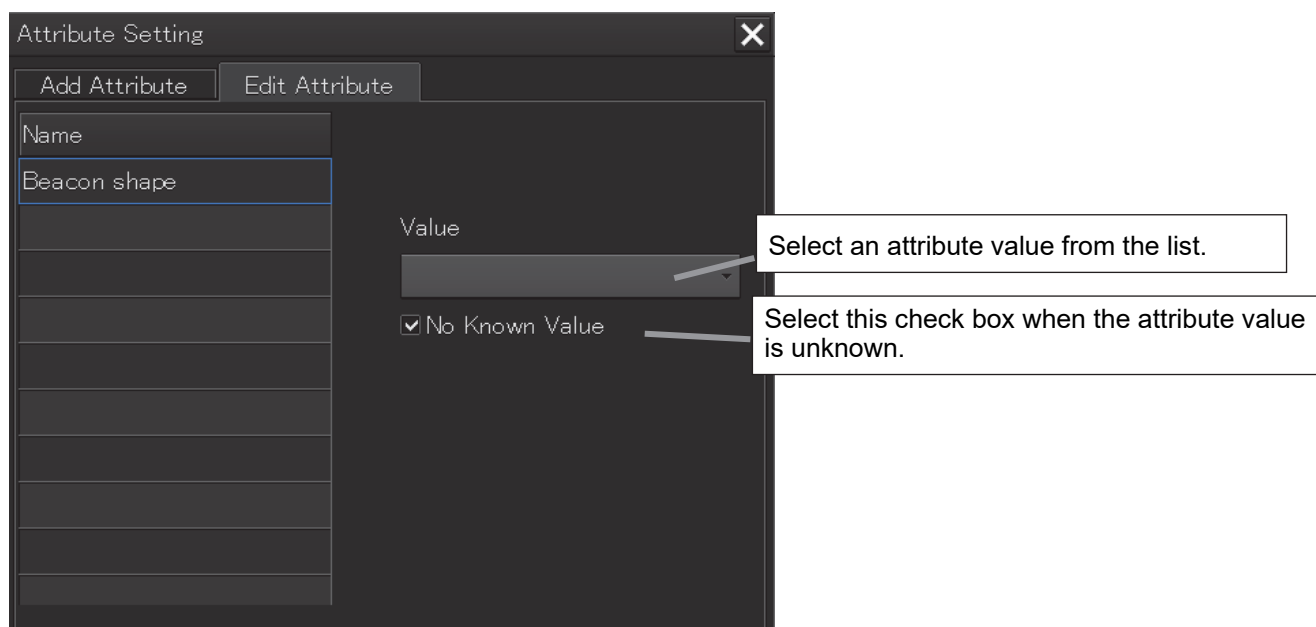

12.10.9.2 Type L

The screenshot shows the 'Attribute Setting' dialog with the 'Edit Attribute' tab selected. The 'Name' field contains 'Colour'. Below it is a list of attribute values: 'white', 'black', 'red', and 'green', each with an unchecked checkbox. Below the list are 'Add' and 'Delete' buttons. A second 'Values' group is shown below, which is currently empty. Callouts explain the 'Add' and 'Delete' actions and the list of values.

The selected attribute value of the Values group is added to the Selected Values group.

Selectable attribute value list. Check the attribute value to be added to the Selected

The selected attribute value is deleted from the Selected Values group.

Selectable attribute value list
Check the attribute value to be deleted.

12.10.9.3 Type F

The screenshot shows the 'Attribute Setting' dialog with the 'Edit Attribute' tab selected. The 'Name' field contains 'Buried depth'. Below it is a 'Value' input field containing '0.0' and a checked checkbox labeled 'No Known Value'. Callouts explain the input field and the checkbox.

Enter an attribute value.

Select this check box when the attribute value is unknown.

12.10.9.4 Type I

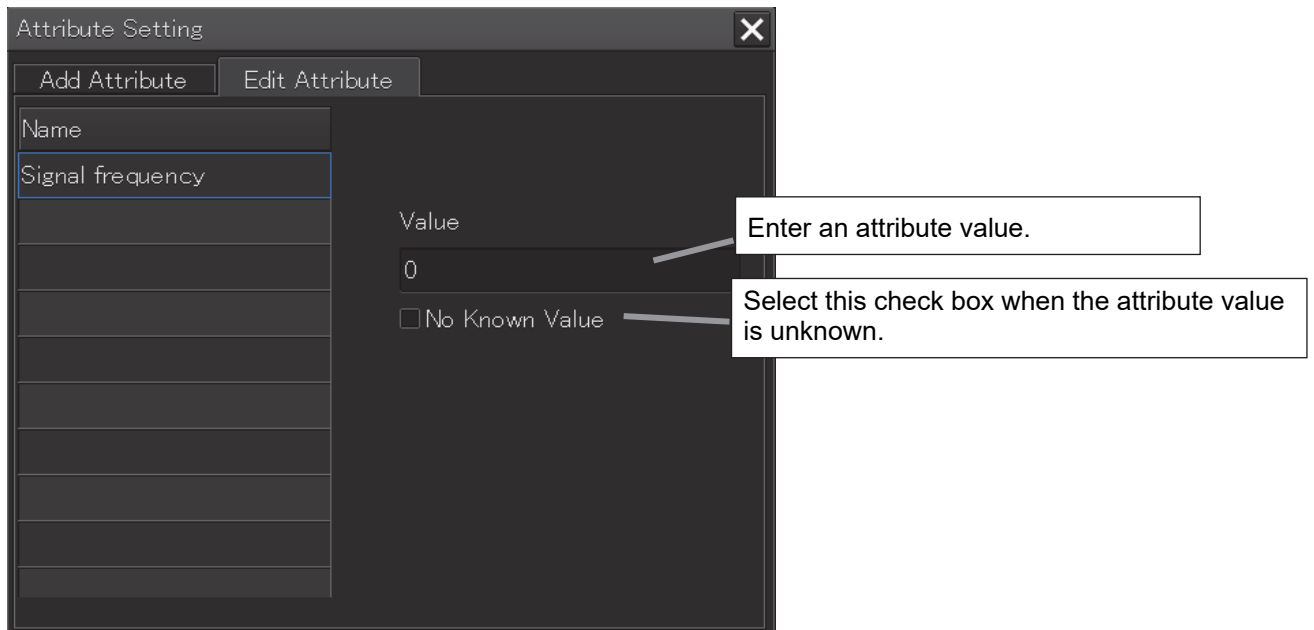



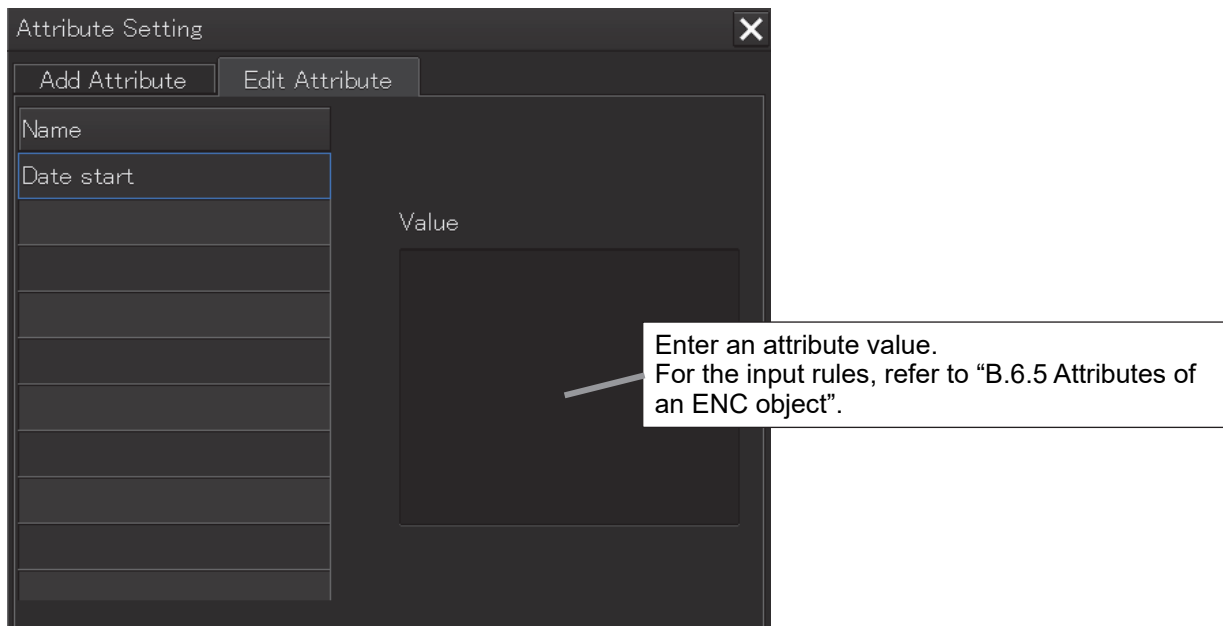







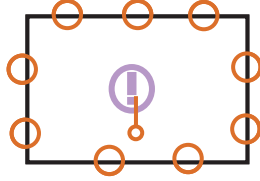



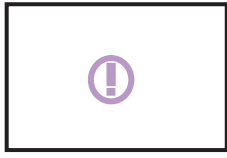
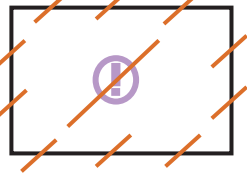



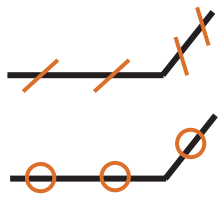



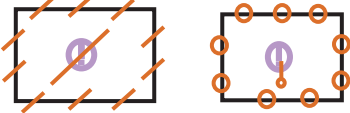

12.10.9.5 Type A/S

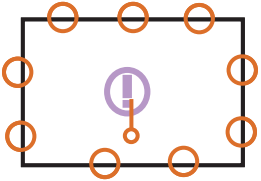

12.10.10 Highlighted display of an object

Highlighted display of a manual update object varies depending on the editing operation or the geometry.

| Operation | Geometry | Before update | After update |
|---|----------|---|---|
| Adding an object | Point | (No object) |  |
| | Line | (No object) |  |
| | Area | (No object) |  |
| Deleting an object | Point |  |  |
| | Line |  |  |
| | Area |  |  |
| Moving an object (Deletes the moving source and highlights the moving destination at addition) | Point |  |  |
| | Line |  |  |

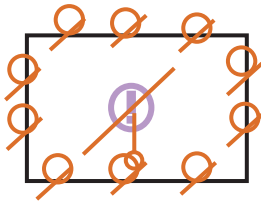
| Operation | Geometry | Before update | After update |
|---|----------|---|---|
| | Area |  |  |
| Editing an object (Addition of ENC object attribute only) | Point |  |  |
| | Line |  |  |
| | Area |  |  |
| Editing an object (Changing the attribute of the ENC object) | Point |  |  |
| | Line |  |  |
| | Area |  |  |

Highlighted display of manual update in route monitoring indicates the difference with the manual update operation performed against the latest automatic update chart status.

Example

- (1) Latest status of automatic update

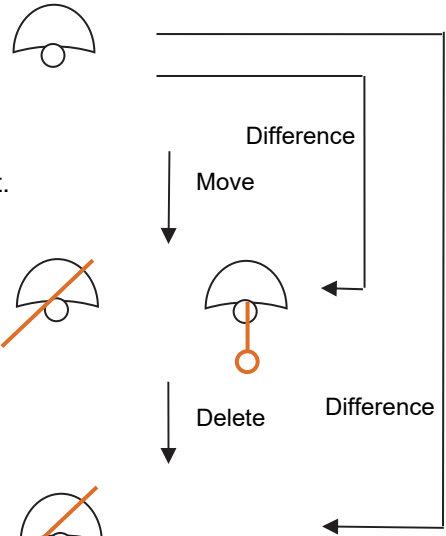

- (2) Move the ENC object in manual update mode and save it.

End the manual update mode.

The state of moving from the latest status of automatic Update is indicated.

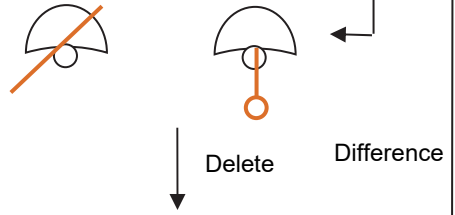

- (3) Restart the manual update mode and delete the ENC object that was moved by the previous editing.

The state of deleting of the latest status of the automatic update is indicated.



Highlighted display of manual update in manual update mode indicates the difference with the manual update operation that is performed against the state that was saved immediately before.

Example

- (1) Restart the manual update mode and delete the ENC object that was moved by the previous editing.

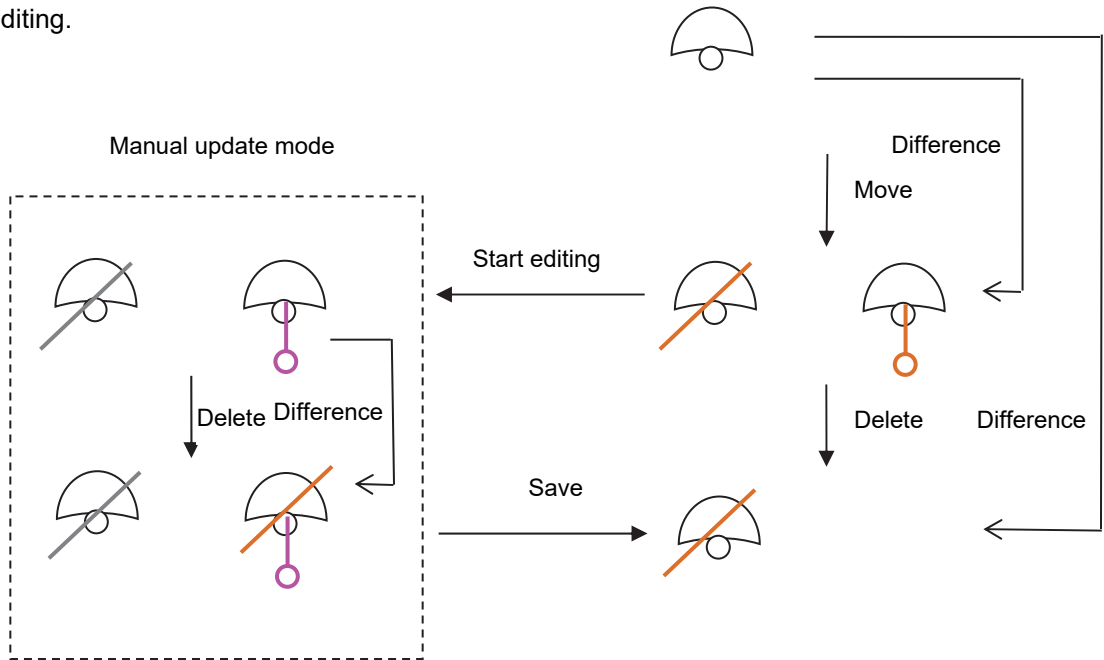

 These highlight symbols are manual update symbols that have been saved previously.
 The symbol in magenta can be picked by the cursor.
 The symbol in grey cannot be picked by the cursor.

12.10.11 Reviewing manual update

(1) Reviewing manual update

The review function can be used for checking the update history on the screen in chart units. In review display mode, “Review” is displayed in the Cursor mode column and manual update operation is disabled.

When a chart is updated in Chart Maintenance mode, the manual update operations that have been performed up to then cannot be displayed for review.

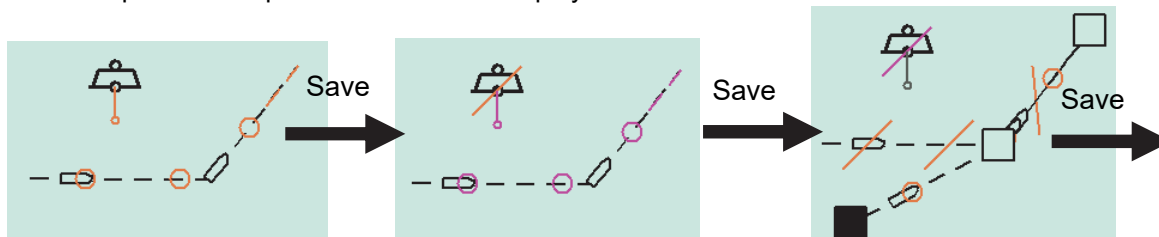

[1] Add a buoy and a ferry route.

[2] Delete the buoy.

[3] Change the ferry route.

A review display example for the above editing is shown below.

Review for the 1st editing (addition of a buoy and a ferry route) is displayed.

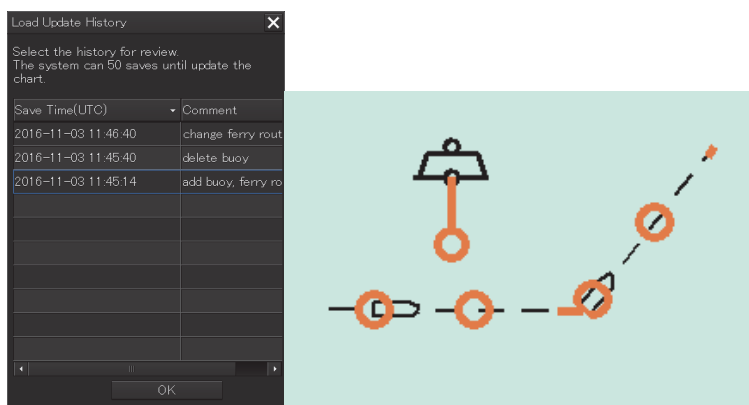

Review for the 2nd editing (deletion of the buoy) is displayed.

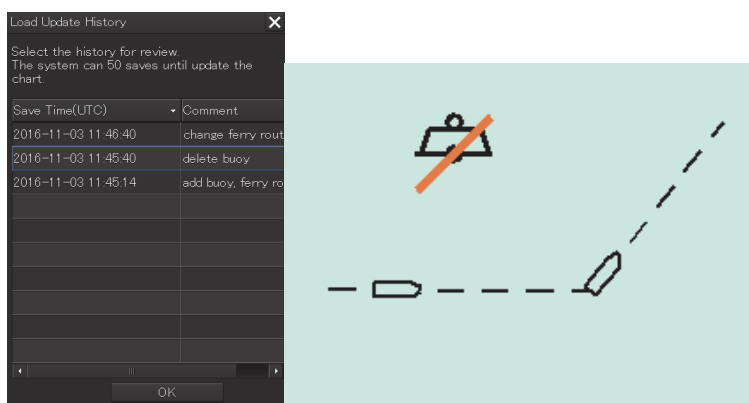

Review for the 3rd editing (change of the ferry route) is displayed.

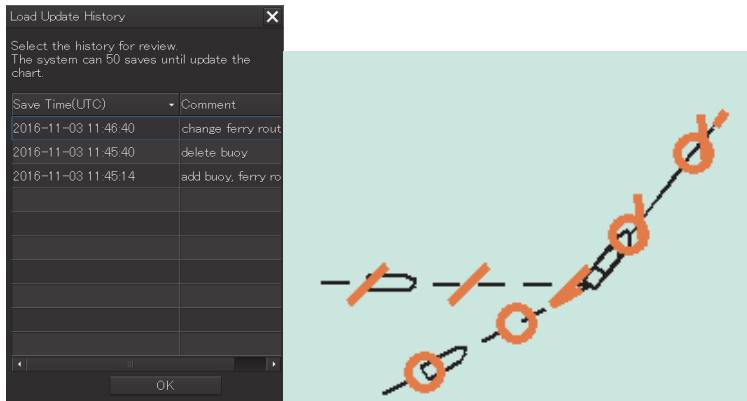

To enter in this mode, use the following procedure on a normal menu.

- 1) Select [Menu] – [Chart] – [Manual Update].
- 2) Select a chart to be reviewed by clicking on the [Select Chart] button.
- 3) Click on the [Load] button and open the Load Update History dialog.
- 4) Select a history to be reviewed and click on the [OK] button.
- 5) Check [Review] on the tool bar.

(By keeping [Review] checked, history can be displayed thereafter by performing 3) and 4).)

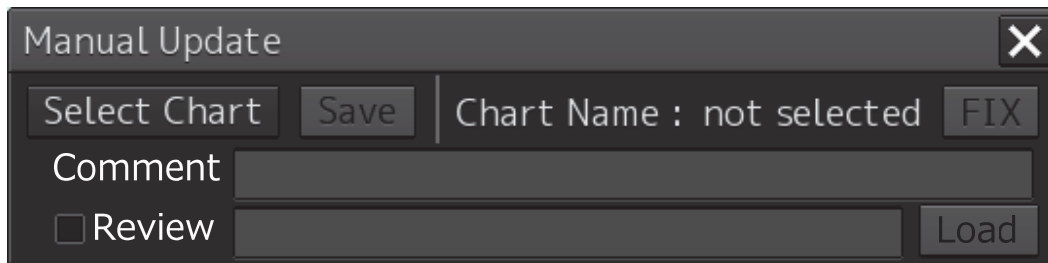

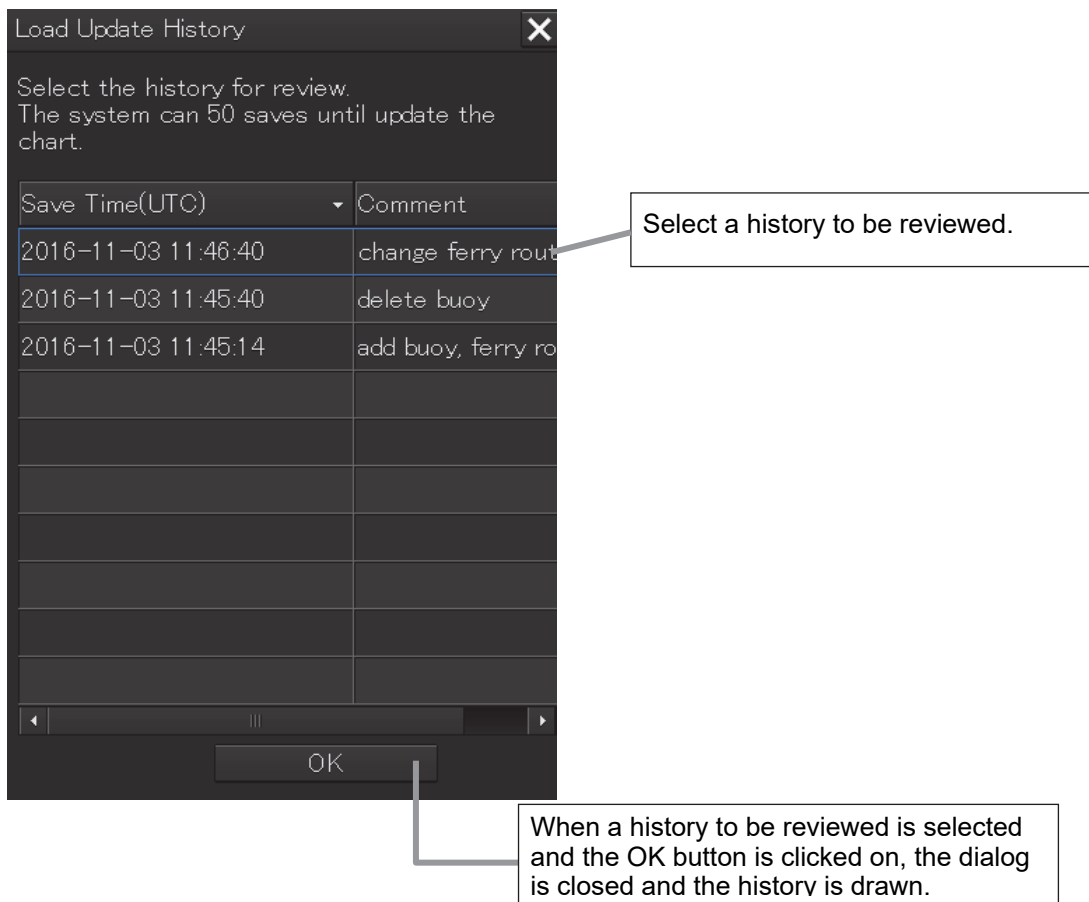

(2) Displaying manual update history

The manual update editing contents are output to the update history of the chart in text format.

- 1) Click the right mouse button on the chart and select [Readout Information] on the shortcut menu.

The cross-hairs cursor changes to the box cursor (SEL (+)).

- 2) Use the trackball to move the cursor onto the chart edited by manual update, and then click the left mouse button.

The [Chart Information] dialog box is opened.

- 3) Select the [Update History] tab of [Chart Information]. The updated contents are displayed following <MANUAL> are displayed in text format.

Hint!

- The history indicates the difference between the information before being saved and the information after being saved. For instance, when, in edit mode, operation is performed in the order of [1] an object is added to the initial position, [2] the object is moved, and [3] the edited contents are saved, the history indicates the new addition to the last position to which the object was moved.
- The latitude and longitude that are output to the history indicates only one coordinate point of the edited line object or area object. This does not indicate the coordinates of the vertex to which the object was moved.

The screenshot shows a 'Chart Information' dialog box with the following elements and callouts:

- Navigation Callouts:**
 - 'Return to the initial page' points to the first left arrow button.
 - 'Return to the previous page' points to the second left arrow button.
 - 'Go to the next page' points to the first right arrow button.
 - 'Go to the last page' points to the second right arrow button.
- Dialog Content:**
 - Buttons: Object, Chart Legend, Update History
 - Dropdown: Name All
 - Page indicator: Page 1 / 1
 - Text: [---] ----- <MANUAL> 03 NOV 2016 11:45:14
 - Text: Save Time : 03-NOV-2016 11:45
 - Text: Comment : add buoy, ferry route
 - Text: Buoy, installation(Point)
 - Text: Add Object
 - Text: Set Position : 32° 26.855'S 61° 3.457'E
 - Text: Ferry route(Line)
 - Text: Add Object
 - Text: Set Position : 32° 27.397'S 61° 3.163'E
 - Text: Ferry route(Line)
 - Text: Add Object
 - Text: Set Position : 32° 26.878'S 61° 6.047'E
 - Text: Buoy, installation(Point)
 - Text: Add Object
 - Text: Set Position : 32° 26.453'S 61° 6.575'E
 - Text: [---] ----- <MANUAL> 03 NOV 2016 11:45:40
 - Text: Save Time : 03-NOV-2016 11:45
 - Text: Comment : delete buoy
 - Text: Buoy, installation(Point)
- Editing History Callouts:**
 - '1st editing history' points to the first three entries (Buoy, installation; Ferry route; Ferry route).
 - '2nd editing history' points to the last three entries (Buoy, installation; [---] -----; Buoy, installation).

12.10.12 Object Delete function

The Delete function attaches a deletion symbol onto the ENC object or saved manual update object.

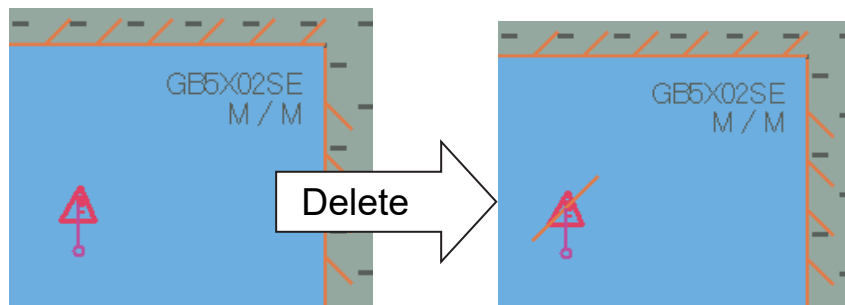

If Delete is executed for the object that was added after the start of editing, the object is deleted.

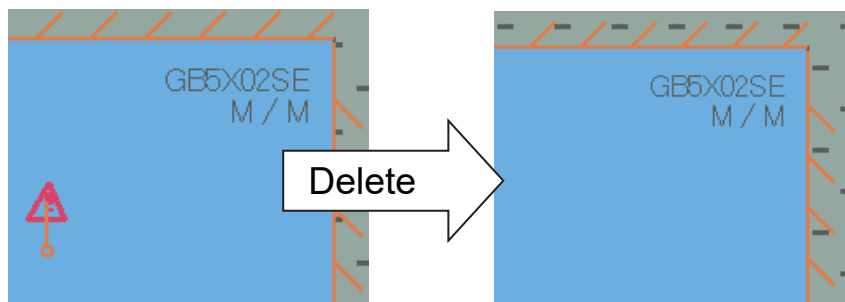

| Operation/duration | Operation |
|--|---|
| Delete operation for the unsaved manual update object | Deletes the operated object. |
| Delete operation for the ENC object and saved manual update object | Attaches a deletion symbol (orange diagonal line) to the operated object. |
| Required or not required to save | Required to save |
| Retention period | Not discarded automatically. |
| Delete operation during Review | Not allowed |
| Editing the deleted object | Only Remove is allowed. |
| Picking the deleted object | Not allowed |

Execution procedure

This function can be executed from the context menu only.

Display the context menu by clicking the right mouse button on the object and select 'Delete this object'.

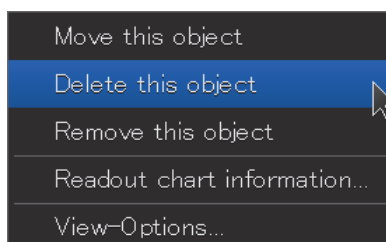

12.10.13 Object Remove function

A saved manual update object can be hidden by using the Remove function. The target object can be hidden without attaching the deletion symbol (orange diagonal line).

By using this function, the information on the removed object can be retained for 3 months (90 days) and can be redisplayed from the history by using the Review function.

The information of the object that has been removed 91 days or earlier can no longer be redisplayed by the Review function.

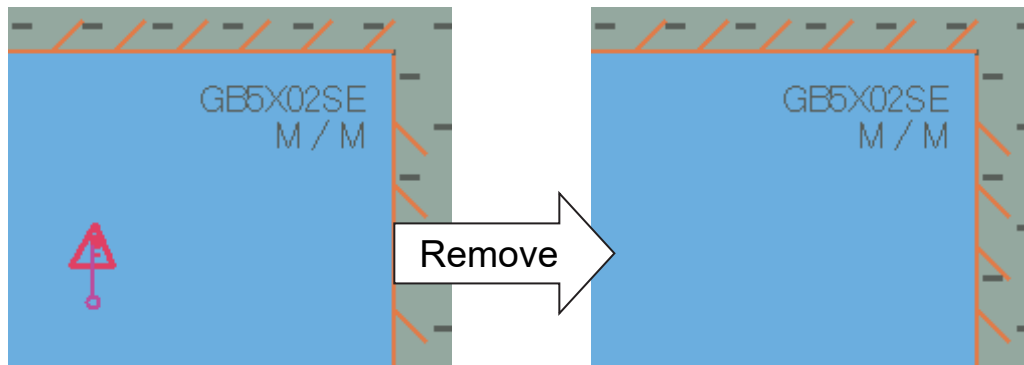

12

| Operation/duration | Remarks |
|---|---|
| Remove operation for the ENC object or the unsaved manual update object | Not possible |
| Remove operation for the saved manual update object | Hides the manual update object that was removed |
| Required to save or not required to save | Required |
| Retention period | 90 days |
| Remove operation during Review | Not possible |
| Picking the removed object | Not possible |

Execution procedure

This function can be executed from the context menu and the eraser tool.

(1) Context menu

Display the context menu by clicking the right mouse button on the object and select 'Remove this object'.

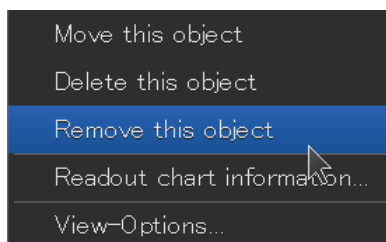

(2) Eraser tool

For the details, refer to "12.9.1 Deleting or hiding an object".

(3) Automatic Remove by Cell Update

When a chart is updated, all the manual update objects are removed automatically.

However, if the edition of the chart is changed, the entire manual update information is discarded.

12.11 Displaying a Pick Report of Manual Update Objects

The display conditions of a pick report of manual update objects are indicated below.

| Item | Display |
|--------------------------------------|-------------|
| Saved manual update object (ENC) | Allowed |
| Saved manual update object (non-ENC) | Not allowed |
| Unsaved manual update object | Not allowed |
| Manual update object during Review | Allowed |
| Deleted manual update object | Not allowed |
| Removed manual update object | Not allowed |
| ENC object | Allowed |

Section 13 Logbook

Various types of information (events) during the voyage can be recorded/displayed in a logbook.

13.1 Browsing a Logbook

- 1 Click on the [Menu] button on the left toolbar.

The menu is displayed.

- 2 Click on [Logbook] on the menu.

The [Logbook] dialog box appears.

The screenshot shows the Logbook dialog box with a date selection box set to 2014-05-18 and an Event group tab selected. The event list on the left shows a series of 'Specified Period' events from 2014-05-18 17:50 to 21:10. The right pane shows detailed information for the selected event, including position (32°28.470'S, 61°00.070'E), course/speed (HDG 255.3°, STW 2.0 kn), depth (**** m), and weather (Air Pressure *****, Air Temperature *** °C, Water Temperature *** °C).

| No. | Date(LMT) | Event |
|-----|------------------|---------------------|
| 231 | 2014-05-18 21:10 | Specified Period |
| 230 | 2014-05-18 21:00 | Specified Period |
| 229 | 2014-05-18 20:50 | Specified Period |
| 228 | 2014-05-18 20:40 | Specified Period |
| 227 | 2014-05-18 20:30 | Specified Period |
| 226 | 2014-05-18 20:20 | Specified Period |
| 225 | 2014-05-18 20:10 | Specified Period |
| 224 | 2014-05-18 20:00 | Specified Period |
| 223 | 2014-05-18 19:50 | Specified Period |
| 222 | 2014-05-18 19:40 | Specified Period |
| 221 | 2014-05-18 19:30 | Specified Period |
| 220 | 2014-05-18 19:20 | Specified Period |
| 219 | 2014-05-18 19:10 | Specified Period |
| 218 | 2014-05-18 19:00 | Specified Period |
| 217 | 2014-05-18 18:50 | Specified Period |
| 216 | 2014-05-18 18:48 | Event Mark |
| 215 | 2014-05-18 18:40 | Specified Period |
| 214 | 2014-05-18 18:30 | Specified Period |
| 213 | 2014-05-18 18:20 | Specified Period |
| 212 | 2014-05-18 18:10 | Specified Period |
| 211 | 2014-05-18 18:05 | Manual Position Fix |
| 210 | 2014-05-18 18:00 | Specified Period |
| 209 | 2014-05-18 17:50 | Specified Period |

Event list

Event detail information

Memo

Events that are recorded/displayed in a logbook can be changed by using the [Settings] menu. For the details, refer to "16.12 Setting up Logbook".

The following events are recorded in a logbook.

- At Noon: Recorded at 12:00 (LMT) every day.
- Specified Period: Recorded at any time interval.
- Event Mark: Recorded at marking an event mark.
- Manual Position Fix: Recorded at fixing a position manually.
- Chart Manual Updating: Recorded at updating a chart manually.
- System Start: Recorded at the start of the system.
- System Exit: Recorded at the termination of the system.
- Route Alert: Recorded at the occurrence of a Route-related alert.
- Chart Alert: Recorded at the occurrence of a Chart-related alert.
- Autosail Alert: Recorded at the occurrence of an automatic sailing related-alert and sensor alarm
- System Alert: Recorded at the occurrence of an alert that does not belong to the types that are indicated above
- MOB Start: Recorded when MOB starts.
- MOB Stop: Recorded when MOB stops.

Searching an event based on the date

Enter a date and time in the date selection box.

The events of the date and time that were input are searched. The event list is scrolled and the line of the first event is highlighted in blue.

Sorting events

When turning on the power, events are registered in the event list starting from the event of the latest date.

When any of the items of the title line in the event list is clicked on, the events can be sorted based on the item. Whenever the item is clicked on, the events are sorted in the ascending order or descending order.

Switching the event groups

Events are classified into the following three event groups. When any of these tabs is clicked, the associated events are displayed.

- [User Task Log] tab: Displays the events relating to user operations.
- [Navigation Alert Log] tab: Displays the events relating to navigation alerts.
- [System Alert Log] tab: Displays the events relating to system alerts.

13.1.1 Event detail information

Navigation record data is displayed as event detail information.

The screenshot shows a detailed form for event information. At the top, there are columns for 'Date', 'Time', and 'Time difference'. The main form is divided into several sections:

- Event name:** Event (Specified Period), 2014-05-18 21:10, -09:00
- Event descriptions:** Descriptions
- Own ship's position:** Position (32°28.470'S, 61°00.070'E), Course/Speed (HDG: 255.3°, STW: 2.0 kn, COG: 255.3°, SOG: 2.0 kn, Av.(4h): 2.0 kn, Av.(24h): 13.3 kn)
- Position sensor type 1:** POSN1 (GPS1)
- Position sensor type 2:** POSN2
- Water depth:** Depth (**** m)
- Chart name:** Chart (GB4X0000, INFO)
- Current direction:** Current (Set: °, Drift: kn)
- Current speed:** Wind (Dir: ****°, SPD: **** kn, BFT: dropdown)
- Wave direction:** Wave (Dir: ****°, Height: *** m)
- Wave height:** Wind speed (Beaufort scale)
- Voyage distance (ground):** (Ground) 63.53 NM
- Voyage distance (water):** (Water) 63.26 NM
- Engine revolution:** Engine Rev. 1000.0 RPM
- Weather:** Air Pressure (**** hPa), Air Temperature (*** °C), Water Temperature (*** °C), Weather Condition (dropdown)
- Comment:** Comment

Detail information that can be edited

The information below can be edited during browsing.

- [Depth] (Water depth):** Enter a value within the range from 0 to 999.9 m.
- [Engine Rev.] (Engine revolution):** Enter a value within the range from -9999.9 to 9999.9 rpm.
- [Wind Dir.] (Wind direction):** Enter a value within the range from 0 to 359.9°.
- [Wind SPD] (Wind speed):** Enter a value within the range from 0 to 200.0 kn.
- [Wave Dir.] (Wave direction):** Enter a value within the range from 0 to 359.9°.
- [Wave Height] (Wave height):** Enter a value within the range from 0 to 50.0 m.
- [Air Press.] (Air pressure):** Enter a value within the range from 0 to 2000.0 hPa.
- [Air Temp.] (Air temperature):** Enter a value within the range from -50.0 to 99.9°C.
- [Water Temp.] (Water temperature):** Enter a value within the range from -10.0 to 50.0°C.

The information below can be input manually. The setting can be selected from the list.

[Beaufort scale]

- 0: Calm
- 1: Light air
- 2: Light breeze
- 3: Gentle breeze
- 4: Moderate breeze
- 5: Fresh breeze
- 6: Strong breeze
- 7: Near gale
- 8: Gale
- 9: Strong gale
- 10: Storm
- 11: Violent storm
- 12: Hurricane

[Weather condition]

- b: Blue sky
- bc: Fine but cloudy
- c: Cloudy
- o: Overcast
- r: Rainy
- q: Squalls
- s: Snow
- f: Foggy

A comment can be input in the [Comment] box by using up to 1000 characters.

13.2 Editing a Logbook

13.2.1 Adding an event

1 Click on the [Event] button.

An event mark is plotted at the own ship's position. An event called "Event Mark" is created with the current time and is registered in the top line of the event list.

The navigation data that has been acquired automatically is displayed as event detail information.

Memo

The data that is not automatically acquired is displayed as blank space.

The screenshot shows the Logbook application window. At the top, there is a date field set to 2014-05-18 and an [Event] button. Below this are three tabs: User Task Log, Navigation Alert Log, and System Alert Log. The main area is a table with columns for No., Date(LMT), and Event. The table lists events from No. 209 to 231. Event No. 216 is labeled 'Event Mark'. To the right of the table is a detailed view for the selected event (No. 231). This view includes fields for Position (32°28.470'S, 61°00.070'E), Course/Speed (HDG 255.3°, STW 2.0 kn, COG 255.3°, SOG 2.0 kn, Av.(4h) 2.0 kn, Av.(24h) 13.3 kn), Depth (**** m), Chart (GB4X0000), Current (Set, Drift), Wind (Dir. ****°, SPD **** kn, BFT), Wave (Dir. ****°, Height *** m), Voyage Distance (Ground 63.53 NM, Water 63.26 NM), Engine Rev. (1000.0 RPM), and Weather (Air Pressure **** hPa, Air Temperature *** °C, Water Temperature *** °C, Weather Condition). A Comment field is at the bottom.

[Event] button

Created event

| No. | Date(LMT) | Event |
|-----|------------------|---------------------|
| 231 | 2014-05-18 21:10 | Specified Period |
| 230 | 2014-05-18 21:00 | Specified Period |
| 229 | 2014-05-18 20:50 | Specified Period |
| 228 | 2014-05-18 20:40 | Specified Period |
| 227 | 2014-05-18 20:30 | Specified Period |
| 226 | 2014-05-18 20:20 | Specified Period |
| 225 | 2014-05-18 20:10 | Specified Period |
| 224 | 2014-05-18 20:00 | Specified Period |
| 223 | 2014-05-18 19:50 | Specified Period |
| 222 | 2014-05-18 19:40 | Specified Period |
| 221 | 2014-05-18 19:30 | Specified Period |
| 220 | 2014-05-18 19:20 | Specified Period |
| 219 | 2014-05-18 19:10 | Specified Period |
| 218 | 2014-05-18 19:00 | Specified Period |
| 217 | 2014-05-18 18:50 | Specified Period |
| 216 | 2014-05-18 18:48 | Event Mark |
| 215 | 2014-05-18 18:40 | Specified Period |
| 214 | 2014-05-18 18:30 | Specified Period |
| 213 | 2014-05-18 18:20 | Specified Period |
| 212 | 2014-05-18 18:10 | Specified Period |
| 211 | 2014-05-18 18:05 | Manual Position Fix |
| 210 | 2014-05-18 18:00 | Specified Period |
| 209 | 2014-05-18 17:50 | Specified Period |

Deleting an event mark

For deletion of event marks, refer to "6.12 Marking the Position of Own Ship with an Event Mark".

13.2.2 Editing event detail information

Use the procedure that is shown below to edit the event detail information that can be edited. For the detail information that can be edited, refer to "Detail information that can be edited" in "13.1.1 Event detail information".

- 1 Click on the box of the data that can be edited.**



- 2 Edit the information by using the software keyboard.**

- 3 Click on the [Enter] key.**

The editing is determined and the data is stored.

13.3 Outputting Event Data

By selecting an event, the detail information can be output as a file.

13.3.1 Outputting a logbook as a file

A logbook data can be output with "File Manager".

- 1 Click on the [Menu] button on the left toolbar.**
The menu is displayed.
- 2 Click on the [Tools] - [File Manager] on the menu.**
The [File Manager] dialog box appears.
- 3 Click on the [File Management] tab.**

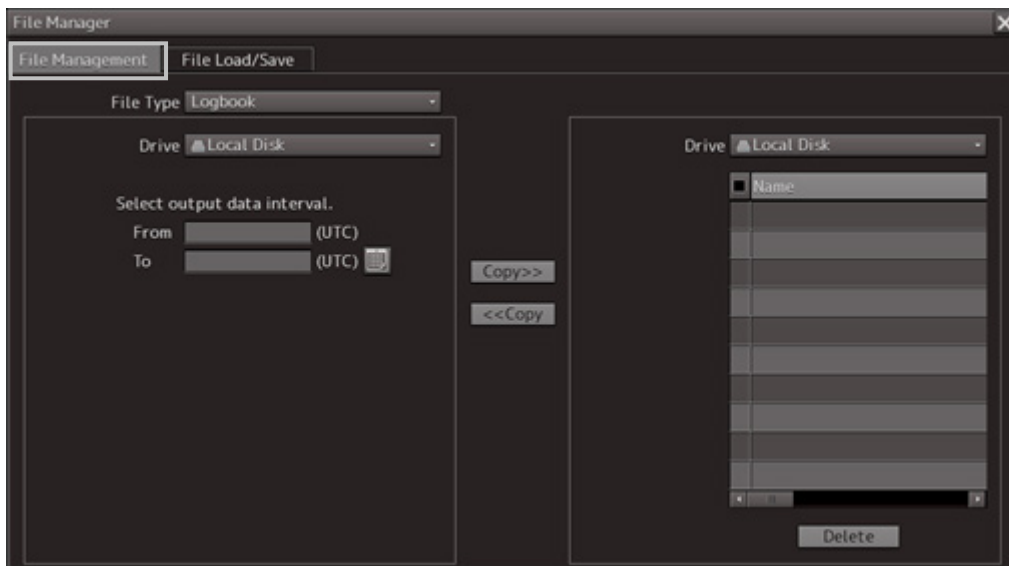

- 4 Select the [Logbook] from the [File Type] combo box.**
- 5 Select the drive containing logbook data from the [Drive] combo box.**

6 Input the period of the logbook data to be output in [From] and [To] of [Select output data interval.].

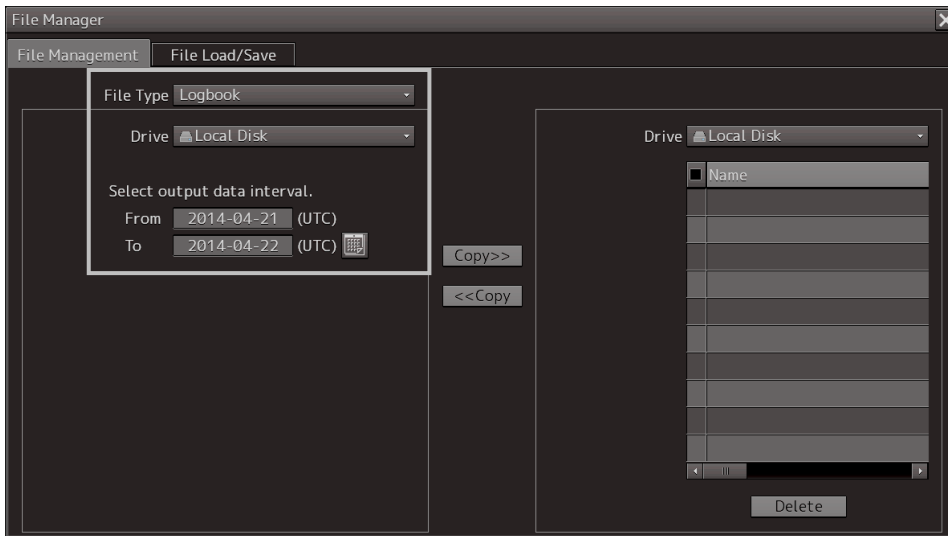

The [Copy] button is enabled.

7 Select the storage destination of the logbook data from the [Drive] combo box of the output destination.

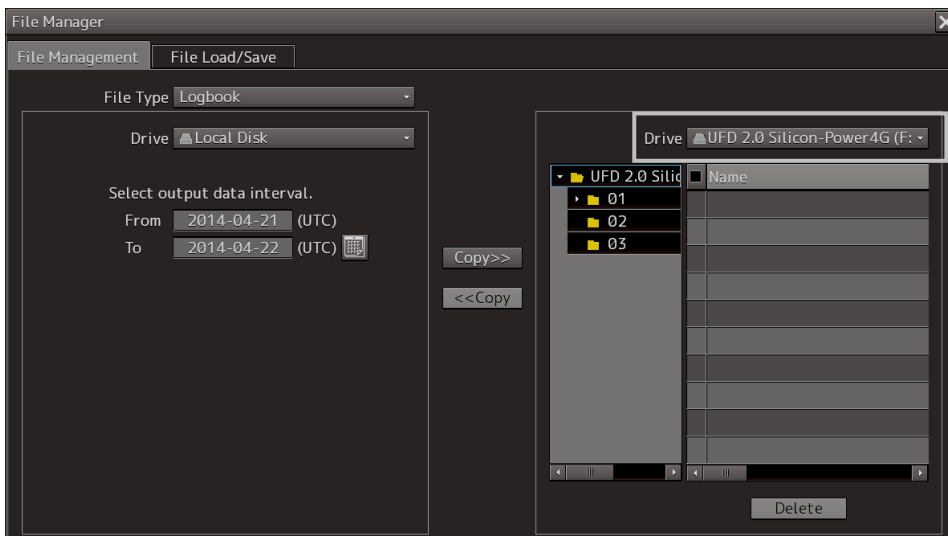

8 Click on the [Copy] button.

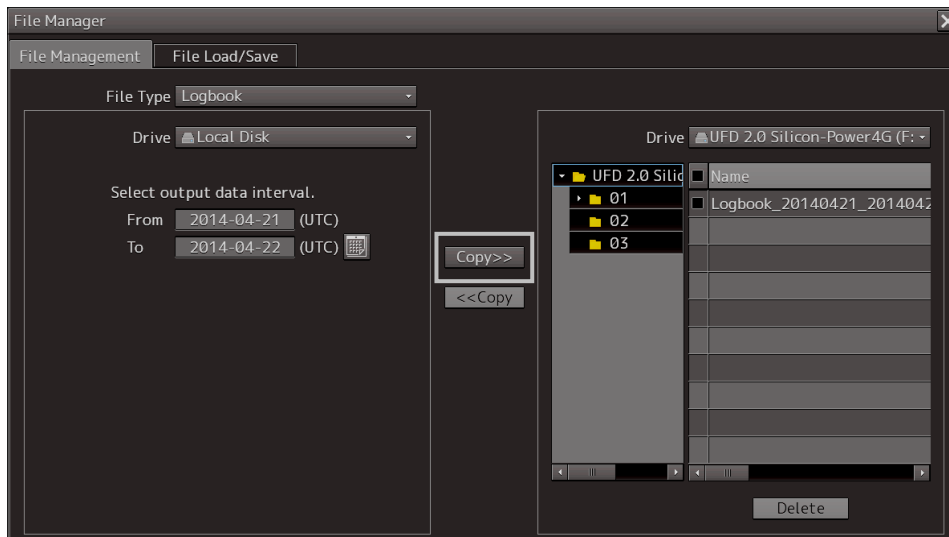

Section 14 Setting up Screen View

Screen display detail is set through the [View] menu.

The display procedure of the View setup dialog box is as follows.

- 1 Click on the [Menu] button on the left toolbar.**
The menu is displayed.
- 2 Click on the [View] button on the menu.**
The submenu is displayed.

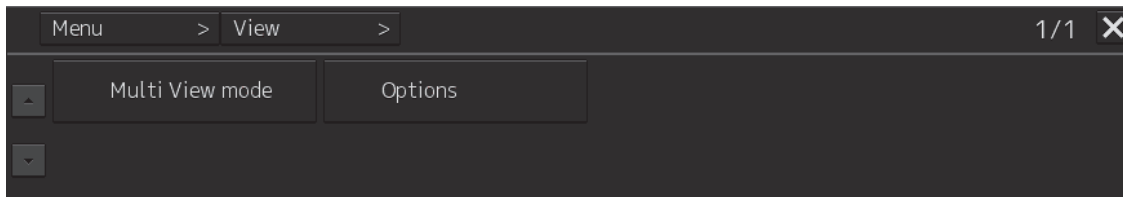

When submenu buttons are clicked, their respective setup dialog boxes are displayed.

| Button | Dialog box | Reference |
|-----------------|------------|---|
| Multi View Mode | | 14.1 Setting Chart Display Mode (Multi View Mode) |
| Options | | 14.2 Setting Screen Display Options |

14.1 Setting Chart Display Mode (Multi View Mode)

In the [View-Multi View Mode] dialog box, chart display modes can be set.

14.1.1 Setting Multi-Screen

For details about how to use the multi-screen, refer to "6.10.1 Displaying multi view".

1 Click on the [Menu] button on the left toolbar.

The menu is displayed.

2 Click on [View] - [Multi View Mode] on the menu.

The [View-Multi View Mode] dialog box appears.

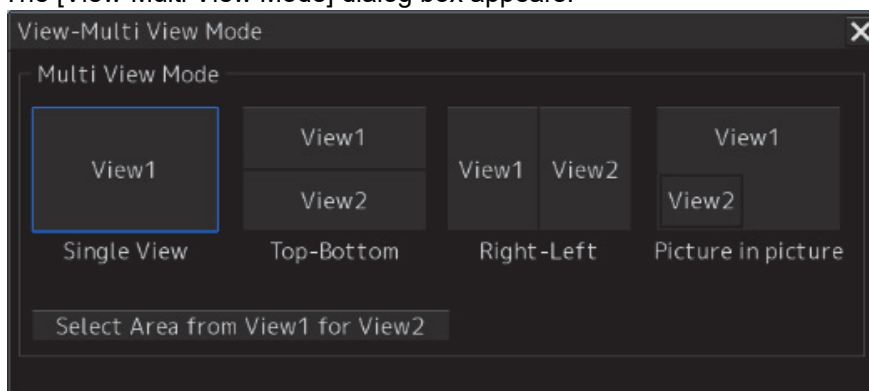

You can select a chart display mode from the following four modes.

- **[Single View Mode]:** Displays a chart in full screen.
- **[Top-Bottom Mode]:** Divides the screen into top and bottom sections; the same or different charts can be displayed in two views of View 1 and View 2.
- **[Right-Left] Mode:** Divides the screen into left and right sections; the same or different charts can be displayed in two views of View 1 and View 2.
- **[Picture in picture] Mode:** Displays the chart in View 2 on top of the chart in View 1 as a child dialog box.

1 Click on the icon of the chart display mode to be used.

A selection frame appears on the icon of the selected mode.

2 Click on the [Select Area from View1 for View2] button.

The button is highlighted.

3 On the chart in View 1, select an area you want to display in View 2.

The selected area is displayed in View 2.

14.2 Setting Screen Display Options

In the [View-Options] dialog box, the screen display options can be set.

Take the following steps to display the [View-Options] dialog box.

- 1 Click on the [Menu] button on the left toolbar.**
The menu is displayed.
- 2 Click on the [View] - [Options] on the menu.**
The [View-Options] dialog box appears.

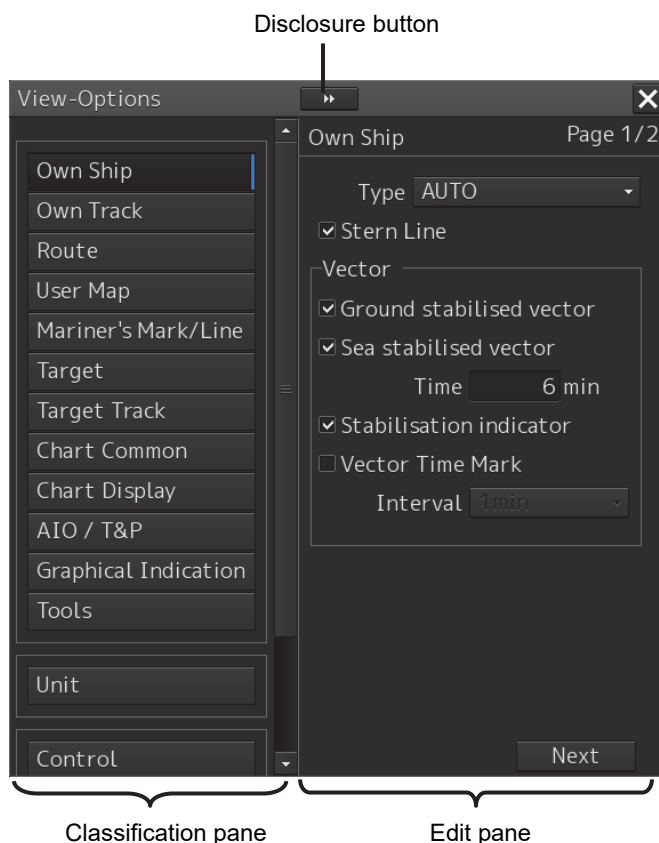

The [View-Options] dialog box consists of the classification pane and edit pane.

Click on the Disclosure button to hide the classification pane.

- 1 Click on the screen view of which you want to set up the options in the classification pane.**
The Option setup dialog box for the screen view you have selected appears in the edit pane.
- 2 Set up in the edit pane.**

Screen display set in the [View-Options] dialog box

The following table shows the classification panes and the related sections.

| Classification pane | Related section |
|---------------------|--|
| Own Ship | 14.2.1 Setting up the display of Own Ship symbol |
| Own Track | 14.2.2 Setting up the display own ship's track |
| Route | 14.2.3 Setting up the display of Route Monitoring |
| User Map | 14.2.5 Setting up the display of User Map |
| Mariner's Mark/Line | 14.2.6 Setting up the display of Mariner's Mark Line |
| RADAR *1 | 14.2.7 Setting up Radar Overlay and Transparency of Echo/Trails |
| Target | 14.2.8 Setting up the display of TT/AIS Target |
| Target Track | 14.2.9 Setting up the display of other ship's track |
| GPS Buoy | - |
| Chart Common | 14.2.10 Setting up the display of Chart Common |
| Chart View | 14.2.11 Setting up the display of Chart |
| AIO | 14.2.12 Setting up AIO display |
| Tools | 14.2.14 Setting up the display of Range/Bearing Measurement Function |
| Unit | 14.2.15 Setting up the display of unit of setting value |
| Control | 14.2.16 Setting up display of Own Ship Track Control, display format of Own Ship/Cursor Position and display of Sub-Information dialog |

*1: In case of JAN-7201S/9201S, RADAR is not available to select by function restriction.

14.2.1 Setting up the display of Own Ship symbol

When you select [Own Ship] in the classification pane, the [Own Ship] dialog is displayed in the edit pane.

Configure the setting for own ship symbols.

The edit pane is divided into two dialogs.

To advance to the next dialog: Click on the [Next] button.

To return to the previous dialog: Click on the [Back] button.

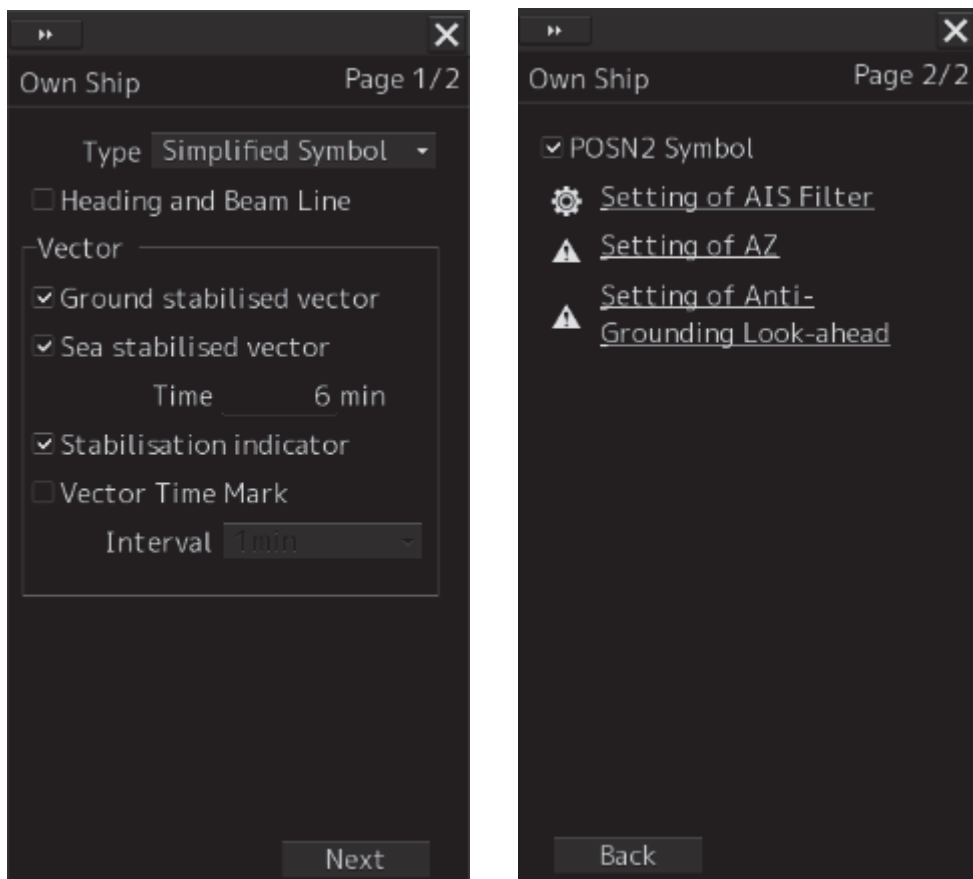

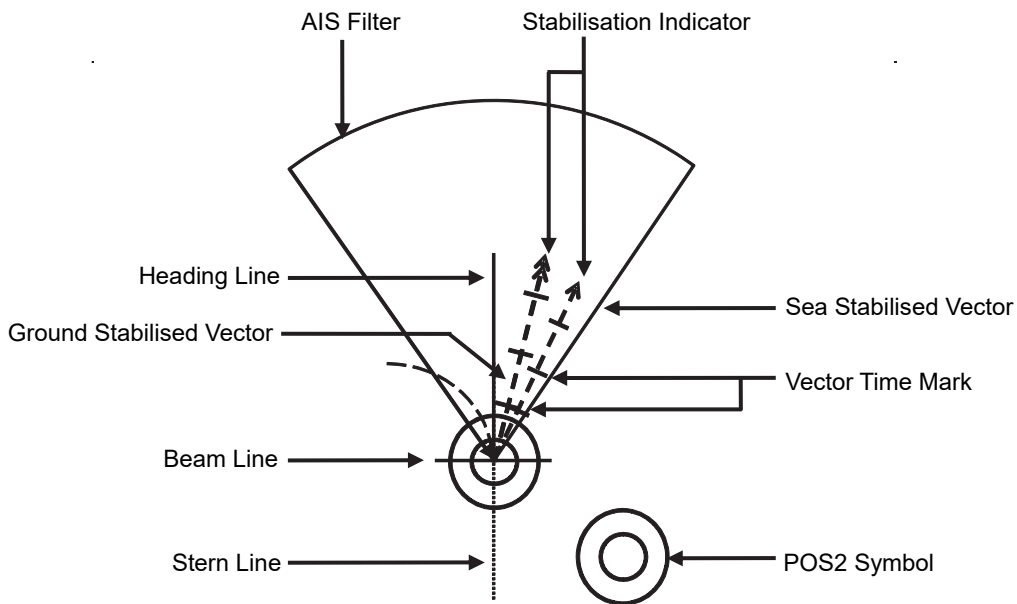

Vector display at primary position

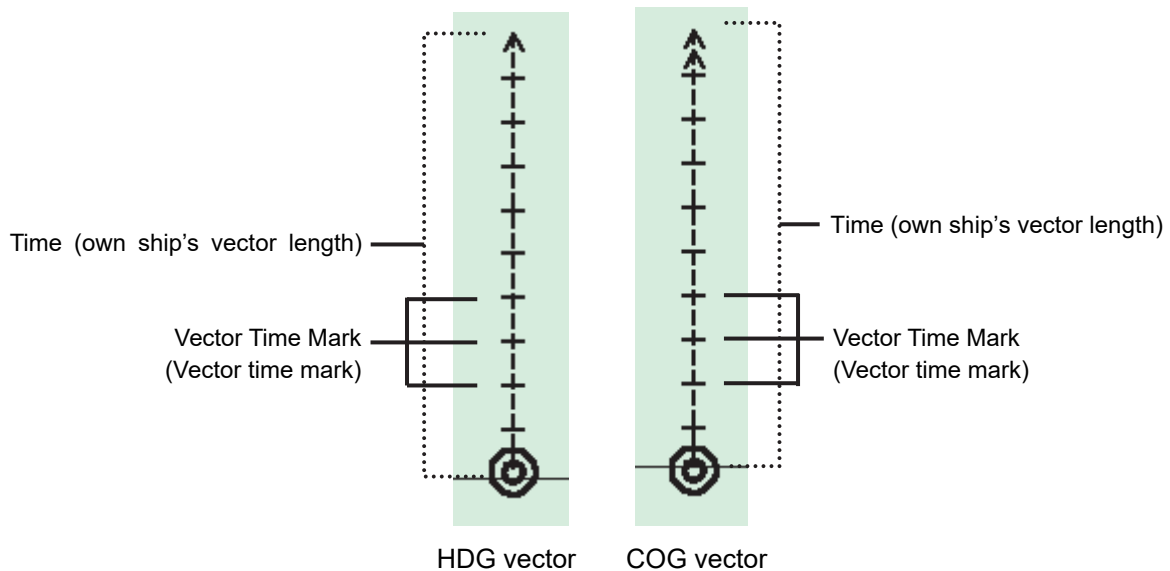

In the own ship symbol, COG (Course Over the Ground) vector, HDG (Heading) vector, and heading line can be displayed. The COG or HDG vector can also be displayed by the length proportionate to the current ship speed in minute by the setting. For example, when the vector length is set to 10 minutes, the vector tip is at the predicted position after 10 minutes if the ship is assumed to navigate at the current speed.



- To display the COG (Course Over the Ground) vector, check [Ground Stabilised Vector] in [Vector].
- To display the HDG (Heading) vector, check [Sea Stabilised Vector] in [Vector].
- To display the heading line, check [Heading and Beam Line].

For details on the setting of type and length of the vector to be displayed, refer to the following table.

The descriptions of settings are shown in the table below.

| Setting Item | Description of Setting | Setting Value |
|--|--|--|
| Type | Select an own ship symbol from the combo box (symbols of other ships are also linked).  : Simplified Symbol  : Outline | Simplified Symbol, Outline |
| Heading and Beam Line (Heading line/beam line display) | Selecting this enables to display heading lines and beam lines. | To enable: Select. To disable: Clear. |
| Ground Stabilised Vector | Selecting this enables to display a ground stabilised vector. | To enable: Select. To disable: Clear. |
| Sea Stabilised Vector | Selecting this enables to display a sea stabilised vector. | To enable: Select. To disable: Clear. |
| Time (Length of own ship's vector) | Enter the own ship's vector length in the box. | 0 to 120 |
| Stabilization Indicator | Selecting this enables to display the stabilization indicator. Note When both the Ground Stabilised Vector and the Sea Stabilised Vector are effective, this automatically takes effect. | To enable: Select. To disable: Clear. |
| Vector Time Mark | Selecting this enables the interval of the vector time mark. | To enable: Select. To disable: Clear. |
| Interval (vector time mark interval) | Select a vector time mark interval from the pull-down menu when Vector Time Mark is valid. | 1 to 6 min |
| POS2 Symbol | Selecting this enables to display the POS2 symbol. Note This item may not be displayed depending on the equipment setting. | To enable: Select. To disable: Clear. |

Shortcuts

Click on any of available shortcuts to display the related dialog box.

| Shortcut | Setup Dialog |
|--|---|
| Setting of AIS Filter | [AIS Filter Setting] dialog box |
| Settings of AZ | [AZ Setting] dialog box |
| Settings of Anti-Grounding Vector/Sector | [Anti-Grounding Vector/Sector Setting] dialog box |

14.2.2 Setting up the display own ship's track

When you select [Own Track] in the classification pane, the [Own Track] dialog is displayed in the edit pane.

Configure the settings for own tracks.

Information of own tracks is recorded in the SSD at every second. Information of a maximum of 24 hours is displayed on a chart as own tracks.

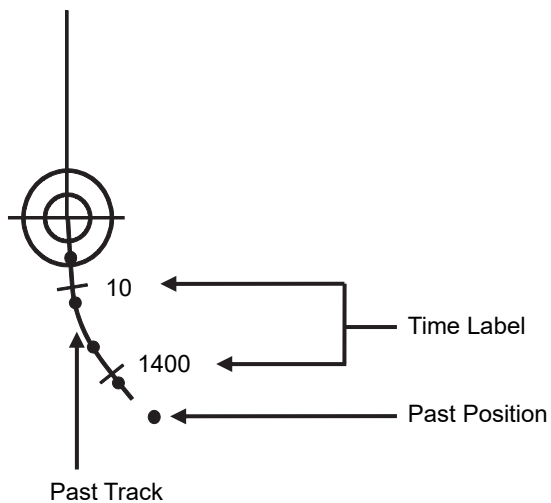
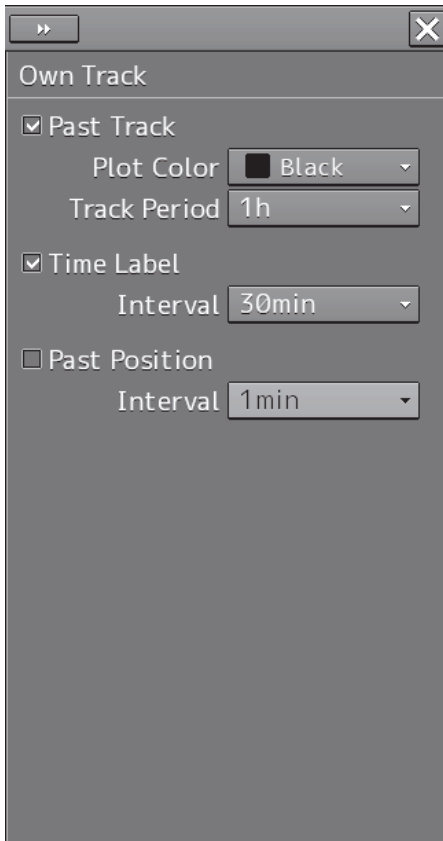

The descriptions of settings are shown in the table below.

| Setting Item | Description of Setting | Setting Value |
|-----------------------------------|--|---|
| Past Track | Selecting this enables to display the past track. | To enable: Select. To disable: Clear. |
| Plot Color (plot color of track) | When Past Track is enabled, select a plot color of the track from the list (preview not supported). | White (Black), Gray, Pink, Magenta, Blue, Cyan, Green, Yellow, Orange, Dark Red Note When the background of the screen is being set to Day1 or Day2, Black can be selected instead of White. |
| Track Period | When Past Track is enabled, select a track period from the list (preview not supported). | 1, 2, 4, 6, 8, 12, 16, 24 h |
| Time Label | Selecting this enables to display the time label interval. | To enable: Select. To disable: Clear. |
| Interval (time label interval) | When Time Label is enabled, select a time label interval from the list (preview not supported). | 1, 3, 5, 10, 30, 60, 120min |
| Past Position | Selecting this enables to display the past position. | To enable: Select. To disable: Clear. |
| Interval (past position interval) | When Past Position is enabled, select an interval of track points from the list (preview not supported). | 0.5 min, 1 min, 2 min, 4 min, 0.1 NM, 0.2 NM, 0.5 NM, 1 NM |

14.2.3 Setting up the display of Route Monitoring

When you select [Route] in the classification pane, the [Route] dialog is displayed in the edit pane. Configure the settings for route monitoring.

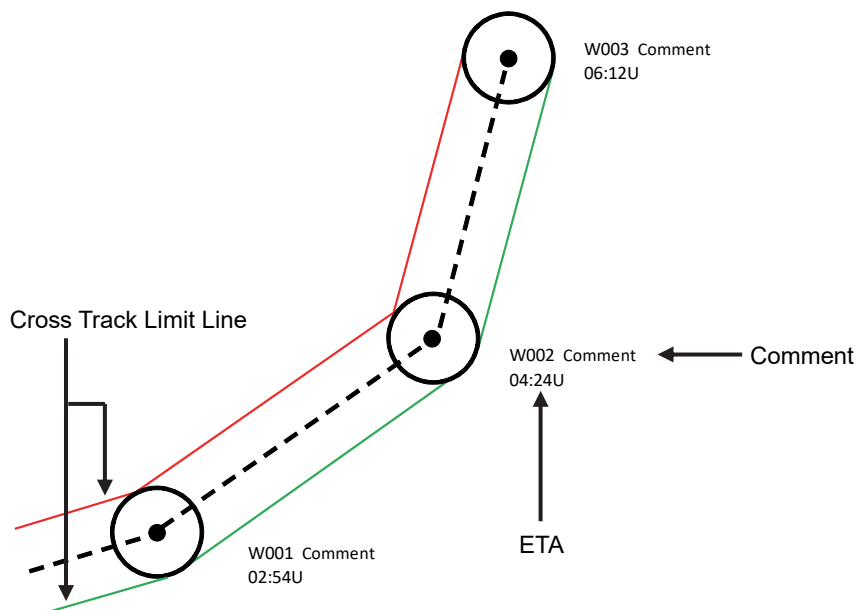
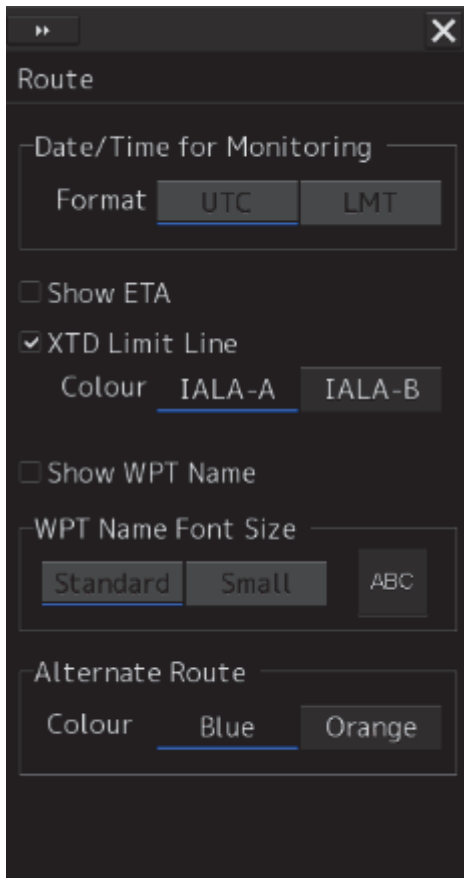

The descriptions of settings are shown in the table below.

| Setting Item | Description of Setting | Setting Value |
|---|--|--|
| Show ETA | Selecting this enables to display the ETA (estimated time of arrival at WPT) while route monitoring. | To enable: Select. To disable: Clear. |
| Format | When ETA is enabled, select a display format of the ETA while route monitoring by clicking on the corresponding button. 04:24U : UTC 13:24L : LMT | UTC/LMT |
| XTD Limit Line | Selecting this enables to display XTD limit lines. | To enable: Select. To disable: Clear. |
| Colour | When Cross Track Limit Line is enabled, select a display color of cross track limit lines by clicking on the corresponding button. IALA-A: Starboard - green, port - red IALA-B: Starboard - red, port - green | IALA-A, IALA-B |
| Show WPT Name (Comment display) | Selecting this enables to display a comment on the vicinity of the target. | To enable: Select. To disable: Clear. |
| WPT Name Font Size (Comment font size) | When Show WPT Name is enabled, select a font size of comments by clicking on the corresponding button (preview not supported). | Standard, Small |

14.2.4 Changing the color of the alternative route

- 1 Click on the [Menu] button on the Left Tool Bar.**
The menu is displayed.
- 2 Click on [View] - [Options] from the menu.**
The [View-Options] dialog box is displayed.
- 3 Select [Route] (ship track) in the category pain.**
The [Route] dialog box is displayed.

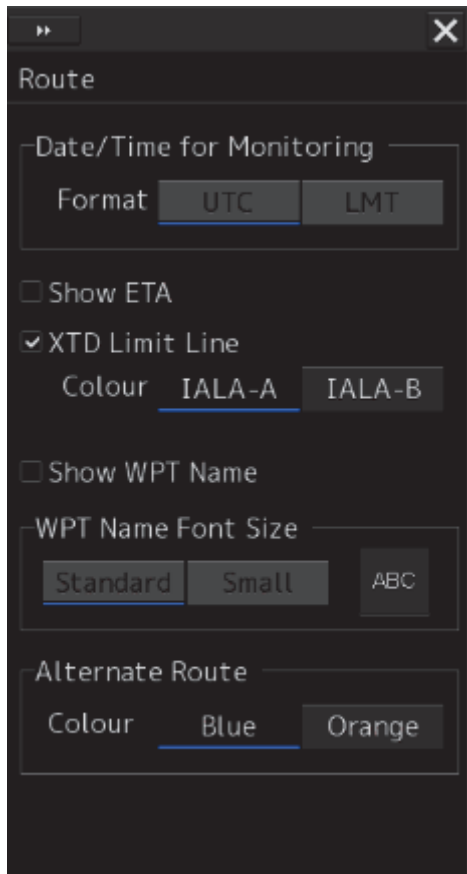

- 4 Select a color in [Alternate Route].**
Blue : Displays Alternate Route in blue.
Orange : Displays Alternate Route in orange.

14.2.5 Setting up the display of User Map

When you select [User Map] in the classification pane, the [User Map] dialog is displayed in the edit pane.

Set up the display of User Map.

The edit pane is divided into two dialogs.

To advance to the next dialog: Click on the [Next] button.

To return to the previous dialog: Click on the [Back] button.

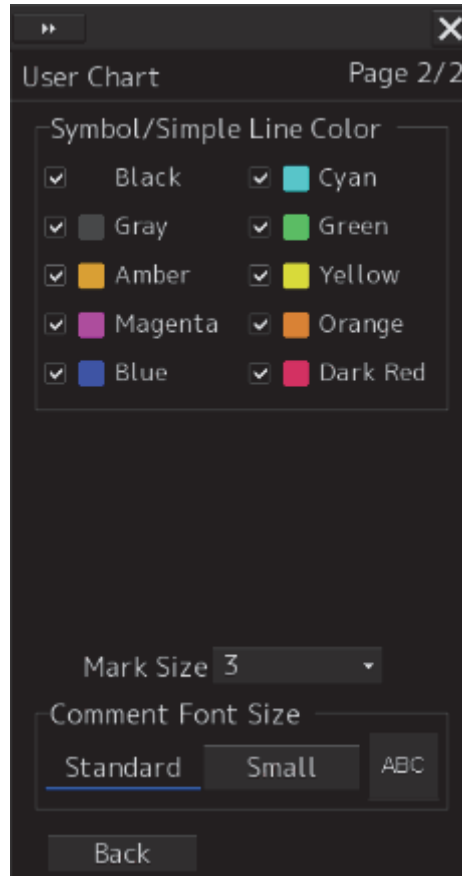
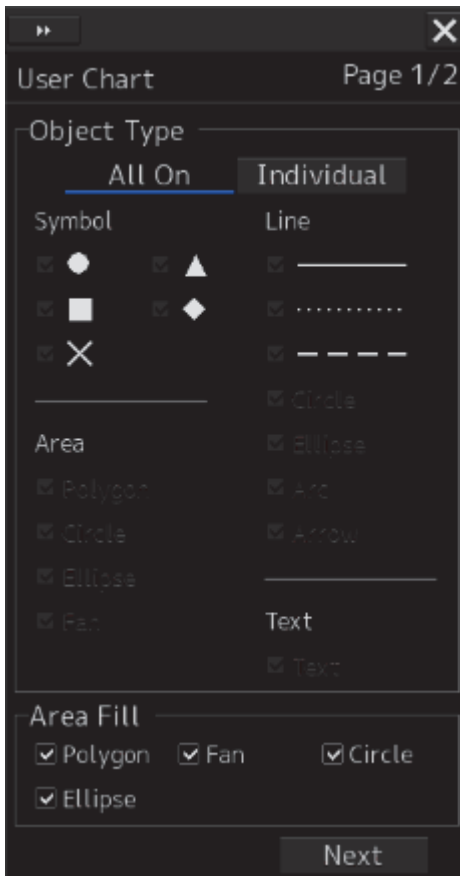

The descriptions of settings are shown in the table below.

| Area | Description of Setting | Setting Value |
|--|--|--|
| Object Type (Object display condition) | Click on the button to specify whether to display or hide the object mark, and select the mark to be displayed. All On: Displays all marks. Individual: Displays selected marks. | All On/Individual Types of selectable marks Symbol: ○, △, □, ◇, × Area: Polygon, Circle, Ellipse, Fan Line: Solid Line, Dotted Line, Dashed Line, Circle, Ellipse, Arc, Arrow Text: Text |
| Area Fill (Fill) | Set the fill color display to On/Off. Check the mark to be set to On. | Off/On |
| Symbol/Simple Line Color (Symbol and simple line color) | Set to On/Off the display of the color that targets the symbol and simple line. Check the color to be set to On. | Off/On |
| Mark Size (Mark size) | Set the mark display size. | 1 (Minimum) /2/3/4/5 (Maximum) |
| Comment Font Size (Comment font size) | Set the font size of the comment. | Standard/Small |

14.2.6 Setting up the display of Mariner's Mark Line

When you select [Mariner's Mark/Line] in the classification pane, the [Mariner's Mark/Line] dialog is displayed in the edit pane.

Select mariner's marks and lines you want to display on the user map by selecting the corresponding check boxes.

You can select the following marks and lines.

- Clearing Line
- Tidal Stream
- Information Mark
- Highlighting
- Event Mark
- Plotted Position

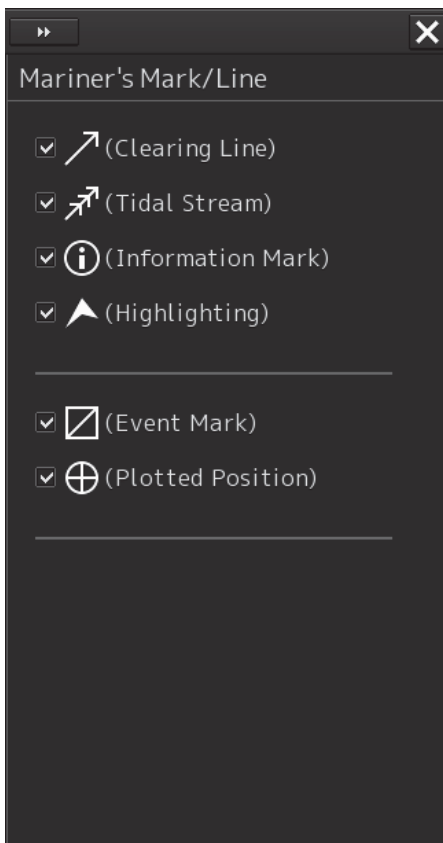

14.2.7 Setting up Radar Overlay and Transparency of Echo/Trails

Note

In case of JAN-7201S/9201S, overlay function is not available by function restriction.
Therefore the setup is not available.

When you select [RADAR] in the classification pane, the [RADAR] dialog is displayed in the edit pane.

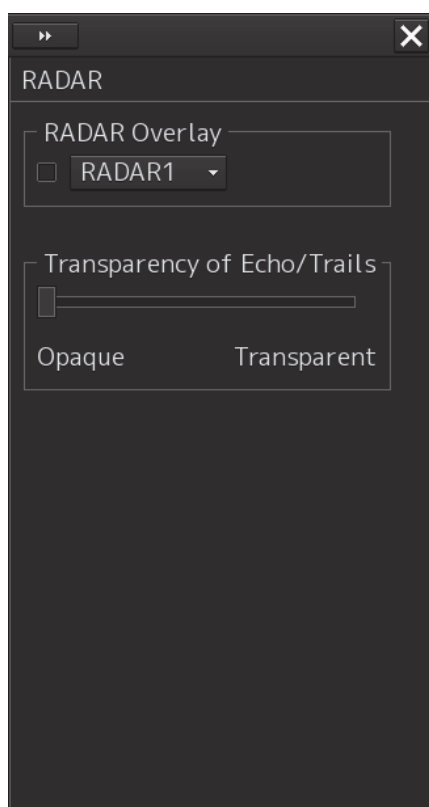

The descriptions of settings are shown in the table below.

| Setting Item | Description of Setting | Setting Value |
|-----------------------------|---|--|
| RADAR Overlay | <p>The radar overlay display turns ON by selecting the [RADAR Overlay]</p> <p>Select the required radar system from the pull-down menu.</p> <p>Note</p> <ul style="list-style-type: none"> • When this item is turned OFF, even the alerts related to the radar will not be displayed. • This item is displayed on the ECDIS screen if RADAR interface is available. | <p>Without interswitch setting RADAR1/RADAR2</p> <p>With interswitch setting RADAR1 to 8</p> |
| Transparency of Echo/Trails | <p>Click on the control on the slider and set up the transparency of echoes/trails.</p> | <p>0 to 15</p> <p>0 = Opaque (Nontransparent)</p> <p>15 = Transparent (Completely transparent)</p> |





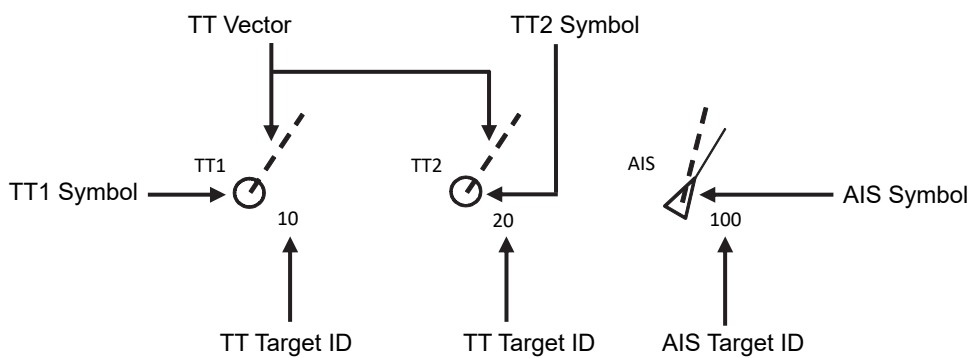
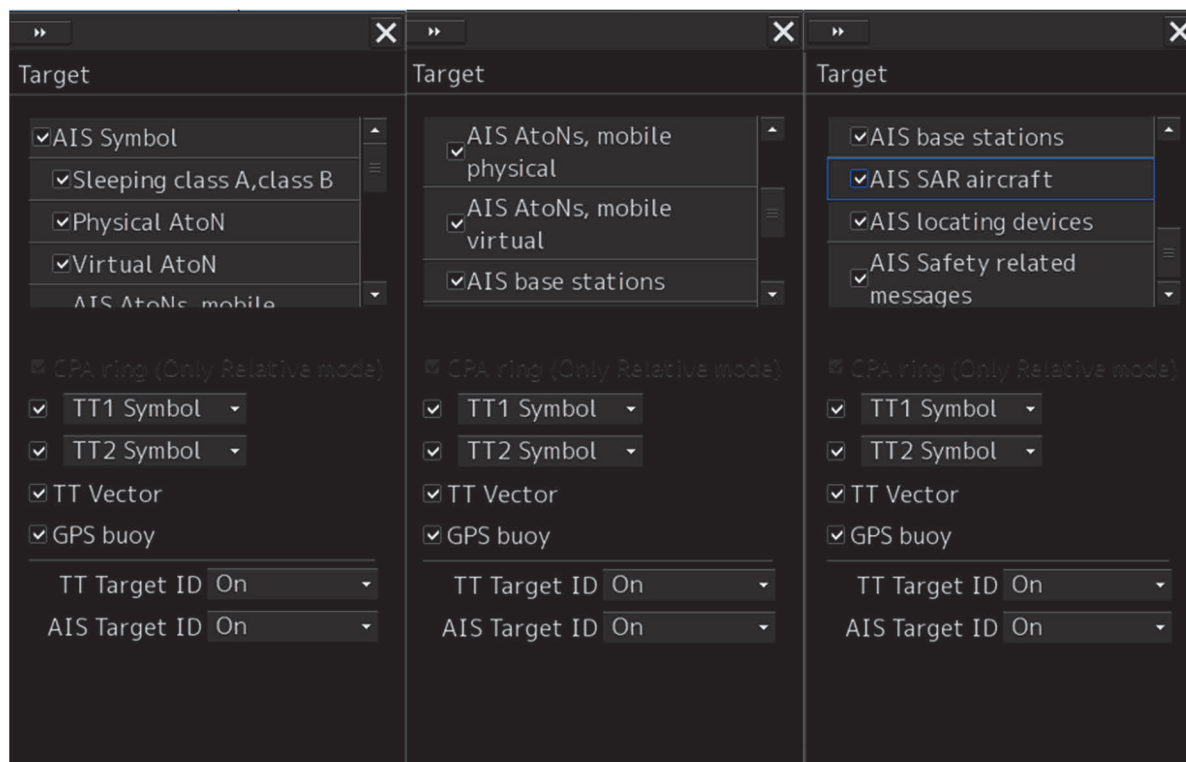



14.2.8 Setting up the display of TT/AIS Target

When you select [Target] in the classification pane, the [Target] dialog is displayed in the edit pane. Configure the settings for TT/AIS targets.



The descriptions of settings are shown in the table below.

| Setting Item | Description of Setting | Setting Value |
|--|--|--|
| AIS Symbol | Selecting this enables to display the AIS symbol. | To enable: Select. To disable: Clear. |
| Sleeping Class A, Class B | Selecting this enables to display the sleeping AIS of class A, ClassB. | To enable: Select. To disable: Clear. |
| Physical AtoN | Selecting this enables to display the Physical AIS AtoN when the AIS Symbol is selected. | To enable: Select. To disable: Clear. |
| Virtual AtoN | Selecting this enables to display the Virtual AIS AtoN when the AIS Symbol is selected. | To enable: Select. To disable: Clear. |
| AIS AtoNs, mobile physical | Selecting this enables to display the AIS AtoNs, mobile physical when the AIS Symbol is selected. | To enable: Select. To disable: Clear. |
| AIS AtoNs, mobile virtual | Selecting this enables to display the AIS AtoNs, mobile virtual when the AIS Symbol is selected. | To enable: Select. To disable: Clear. |
| AIS base stations | Selecting this enables to display the AIS base stations when the AIS Symbol is selected. | To enable: Select. To disable: Clear. |
| AIS SAR aircraft | Selecting this enables to display the AIS SAR aircraft when the AIS Symbol is selected. | To enable: Select. To disable: Clear. |
| AIS locating devices | Selecting this enables to display the AIS locating devices when the AIS Symbol is selected. | To enable: Select. To disable: Clear. |
| AIS Safety related messages | Selecting this enables to display the AIS Safety related messages when the AIS Symbol is selected. | To enable: Select. To disable: Clear. |
| TT1 Symbol (TT1 Symbol) TT2 Symbol (TT2 Symbol) | Select this item to enable the TT symbol. Select the TT Symbol to be used from the combo box. TT1 Symbol indicates the tracked target information that is received from RADAR1 and the TT Target ID is displayed as "T1-***" (** indicates the target number or ship name). TT2 Symbol indicates the tracked target information that is received from RADAR2 and the TT Target ID is displayed as "T2-***" (** indicates the target number or ship name). | To enable: Select. To disable: Clear. |
| TT Vector | Selecting this enables to display the TT vector. | To enable: Select. To disable: Clear. |
| GPS Buoy | Selecting this enables to display the GPS Buoy symbol. | To enable: Select. To disable: Clear. |

| Setting Item | Description of Setting | Setting Value |
|-------------------------------------|--|---------------------------------|
| TT Target ID (Tracked target ID) | <p>Select a display mode of the tracked target ID from the combo box.</p> <p>Off: Hide On: Show</p> <p>TT Track: Displays only the target that shows other ship's track.</p> <p>Display</p> <p>Ship's Name: When the ship's name has been input in the [TT Target INFO] (property of tracked target) dialog, that ship name is displayed. If the ship's name has not been input, the identification number is displayed.</p> <p>Display</p> <p> : Off</p> <p> : On</p> <p> : TT Track</p> <p> : Ship's Name</p> | Off, On, TT Track |
| AIS Target ID | <p>Select a display mode of the AIS target ID from the combo box.</p> <p>Off: Hide On: Show</p> <p>AIS Track: Displays only the target that shows other ship's track (target track).</p> <p>Ship's Name: When a ship's name is input in the [AIS Target INFO] (property of AIS target) dialog, the ship's name is displayed. When no ship's name is input, the ID is displayed.</p> <p>Display</p> <p> : Off</p> <p> : On</p> <p> : TT Track</p> <p> : Ship's Name</p> | Off, On, AIS Track, Ship's Name |

14.2.9 Setting up the display of other ship's track

When you select [Target Track] in the classification pane, the [Target Track] dialog is displayed in the edit pane.

The [Target Track] dialog consists of the [Display], [Plot] and [Clear] tabs.

[Display] tab

On the [Display] tab, set up the display of other ship's tracks.

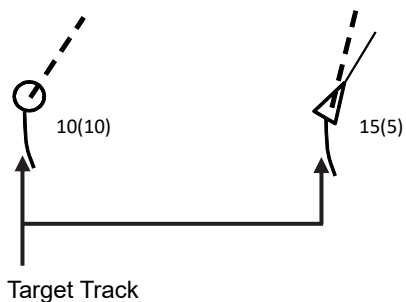
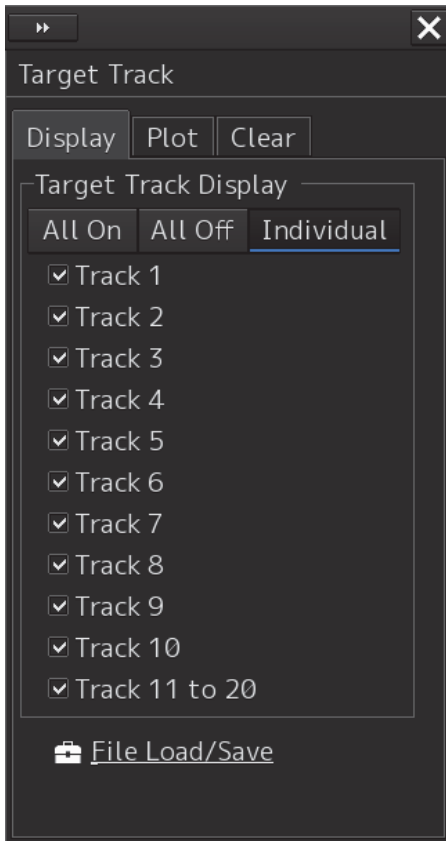

The descriptions of settings are shown in the table below.

| Setting Item | Description of Setting | Setting Value |
|--|---|--|
| Target Track Display (display of other ship's tracks) | Select to show/hide target tracks by clicking on the corresponding buttons and then specify the target tracks you want to display by checking them. All On: Shows all of target tracks. All Off: Hides all of target tracks. Individual: Shows selected target tracks. | All On, All Off When Individual is selected: Select from Tracks 1 to 10 and from Tracks 11 to 20. |

Shortcut

Click on any of available shortcuts to display the related dialog box.

| Shortcut | Setup Dialog Box |
|----------------|---|
| File Load/Save | [File Load/Save] dialog box in File Manager |

[Plot] tab

The edit pane of the [Plot] tab is divided into two dialogs.

To advance to the next dialog: Click on the [Next] button.

To return to the previous dialog: Click on the [Back] button.

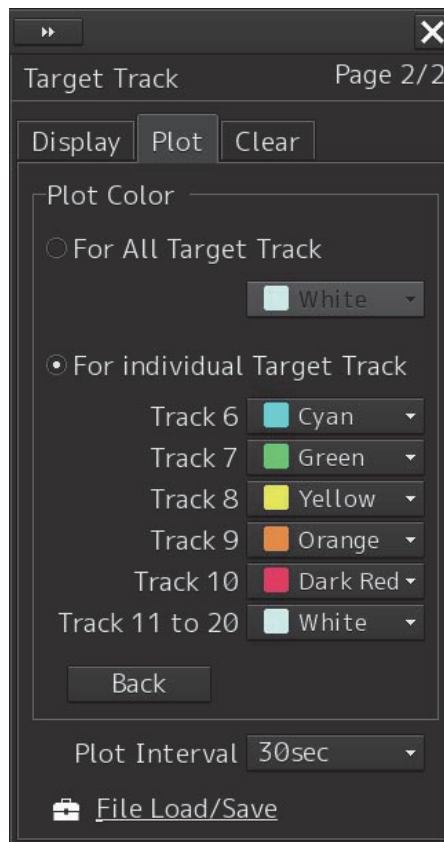
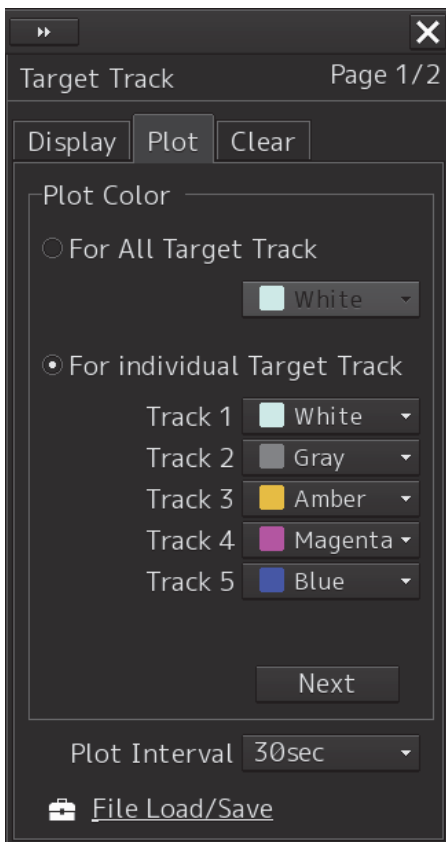

The descriptions of settings are shown in the table below.

| Setting Item | Description of Setting | Setting Value |
|-----------------------------|---|---|
| For All Target Track | Click on the check box and select a plot color of target tracks from the list. | White (Black), Gray, Amber, Magenta, Blue, Cyan, Green, Yellow, Orange and Dark Red |
| For Individual Target Track | Click on the check box and select plot colors of individual target tracks (Tracks 1 to 10 and Tracks 11 to 20) from the list. | White (Black), Gray, Amber, Magenta, Blue, Cyan, Green, Yellow, Orange and Dark Red |
| Plot Interval | Select a plot interval of target tracks from the combo box. | Off, 3s, 5s, 10s, 30s, 1 min, 3 min, 5 min, 10 min, 30 min, 60 min, 1 NM, 3 NM, 5 NM, 10 NM, 0.1 NM, 0.2 NM, 0.3 NM, 0.5 NM |

* White/Black interchanges under the following conditions.
 Black at Day1/Day2 (or Day), white at Day3/Dusk/Night

Shortcut

Click on any of available shortcuts to display the related dialog box.

| Shortcut | Setup Dialog Box |
|----------------|---|
| File Load/Save | [File Load/Save] dialog box in File Manager |

[Clear] tab

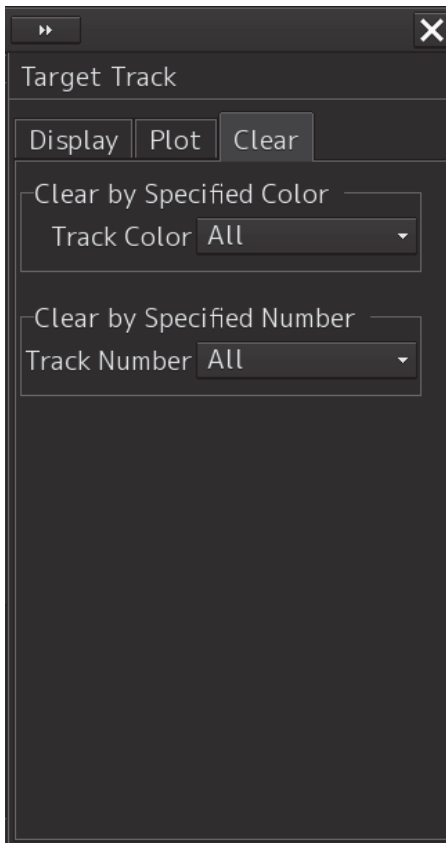

14

To erase tracks by specifying a color

- 1 Select the color of other ship's track to be erased from the [Track Color] combo box.**
You can select from All, White, Gray, Amber, Magenta, Blue, Cyan, Green, Yellow, Orange and Dark Red.
* White/Black interchanges under the following conditions.
Black at Day1/Day2 (or Day), white at Day3/Dusk/Night
A message dialog box prompting you to confirm erasing appears.

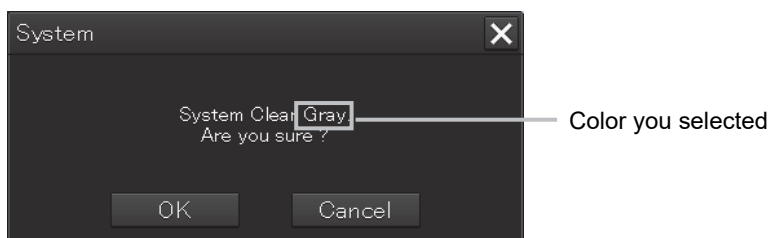

- 2 To execute erasing, click on the [OK] button. To cancel erasing, click on the [Cancel] button or the [X] button.**

To erase tracks by specifying a number

- 1** Select the number of other ship's track to be erased from the [Track Number] combo box.

You can select from All, Track 1, Track 2, Track 3, Track 4, Track 5, Track 6, Track 7, Track 8, Track 9, Track 10 and Track 11 - 20.

An erase confirmation message dialog is displayed

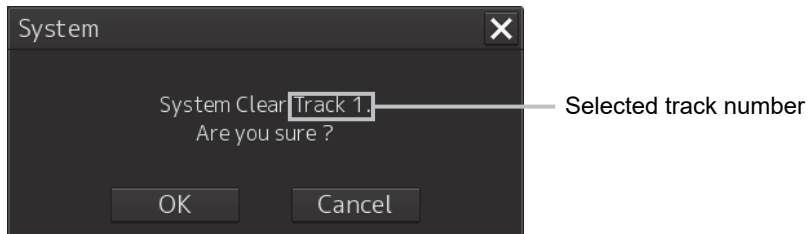

- 2** To execute erasing, click on the [OK] button. To cancel erasing, click on the [Cancel] button or the [X] button.

14.2.10 Setting up the display of Chart Common

When you select [Chart Common] in the classification pane, the [Chart Common] dialog is displayed in the edit pane.



The edit pane is divided into two dialogs.

To advance to the next dialog: Click on the [Next] button.

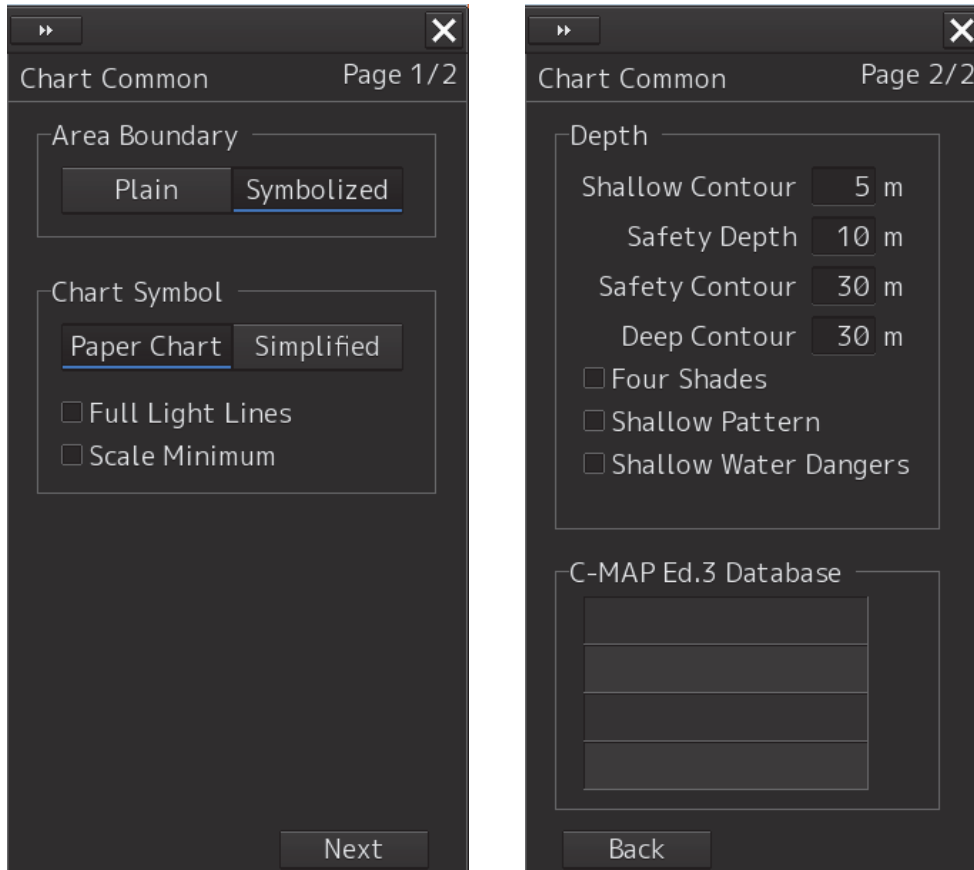
To return to the previous dialog: Click on the [Back] button.

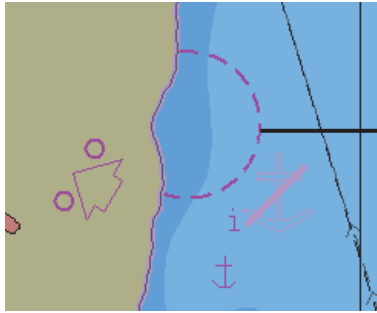
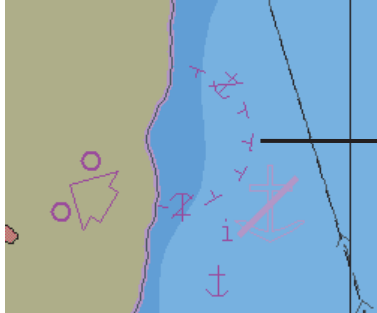
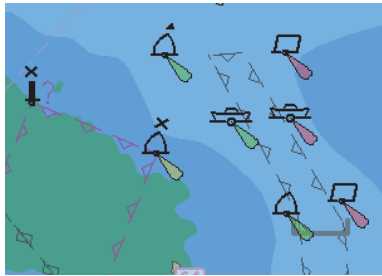
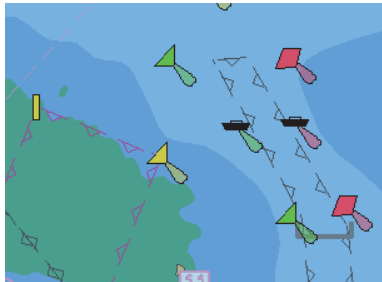

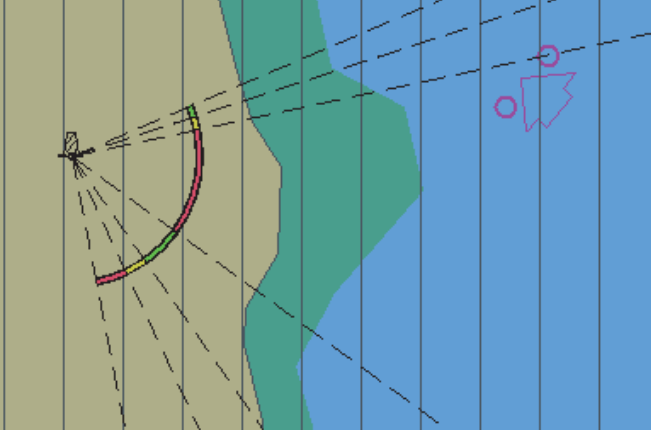
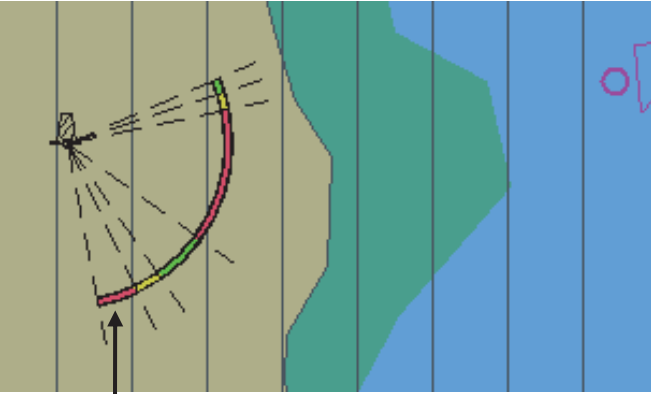
| Setting Item | Description of Setting | Setting Value |
|----------------------|---|------------------------------------|
| <p>Area Boundary</p> | <p>Select a display method of area boundary by clicking on the corresponding button.</p> <p>Plane: Displays a plane boundary (an area boundary is indicated by dotted lines).</p>  <p>Symbolized: Displays a symbol boundary (an area boundary is indicated by symbol lines).</p>  | <p>Plane, Symbolized</p> |
| <p>Chart Symbol</p> | <p>Select a type of chart symbols you want to use on the chart by clicking on the corresponding button.</p> <p>Paper Chart: The same symbols on paper charts are used as symbols for lighthouses, etc.</p>  <p>Simplified: Colored symbols are displayed.</p>  | <p>Paper Chart, Simplified</p> |

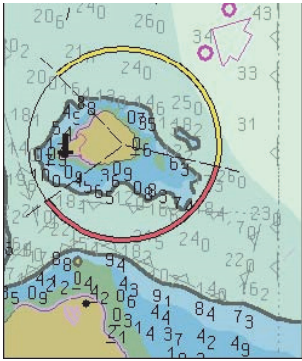
| Setting Item | Description of Setting | Setting Value |
|-------------------------------|--|--|
| <p>Full Light Line</p> | <p>When selected, display of maximum length of full light line is enabled.</p>  <p>When [Full Light Line] is enabled</p>  <p>Light range of lighthouse</p> <p>When [Full Light Line] is disabled.</p> | <p>To enable: Select. To disable: Clear.</p> |
| <p>Consider Scale Minimum</p> | <p>When selected, scale display smaller than the minimum scale setting value is disabled.</p>  <p>When [Consider Scale Minimum] is enabled</p>  <p>When [Consider Scale Minimum] is disabled</p> | <p>To enable: Select. To disable: Clear.</p> |
| <p>Depth</p> | <p>Refer to "Depth."</p> | |

| Setting Item | Description of Setting | Setting Value |
|---------------------|---|----------------------------------|
| Depth | Refer to "Depth." | |
| C-MAP Ed.3 Database | <p>Select this to show a chart database chart. *Only the imported chart databases can be selected.</p> <p>During manual updating of a chart, the C-MAP database list cannot be changed. Therefore, the following restrictions are imposed while the Manual Update tool bar is displayed by selecting [Chart] - [Manual Update] in the menu.</p> <ul style="list-style-type: none"> • Chart Type of [View1] / [View2] cannot be changed in the [View-Options] dialog. • The C-MAP Ed.3 Database check box cannot be changed. <p>The Manual Update tool bar is closed, the restrictions are released.</p> | Shown: Selected Hidden: Clear |

Depth

Use [Depth] items to set up the depth.

| Setting Item | Description of Setting | Setting Value |
|---|---|--|
| Shallow Contour | <p>The shallow contour displayed on the chart is displayed at the set depth.</p> <p>For the display example, refer to "(1) Example of displaying Shallow Contour/Safety Contour/Deep Contour."</p> | 0 to 200 |
| Safety Depth | <p>The spot depth that is lower than the set value is highlighted for display.</p> | 0 to 200 |
| Safety Contour | <p>The set depth value on the chart (or depth that is lower than the set value) is highlighted for display.</p> <p>In the sea area that is shallower than the set value, an alarm occurs.</p> <p>*If the safety contour appropriate to the set depth is not provided on the chart, the safety contour that is deeper than the set value is displayed.</p> <p>For the display example, refer to "(1) Example of displaying Shallow Contour/Safety Contour/Deep Contour."</p> | 0 to 200 *1 |
| Deep Contour | <p>The deep contour displayed on the chart is displayed at the set depth.</p> <p>For the display example, refer to "(1) Example of displaying Shallow Contour/Safety Contour/Deep Contour."</p> | 0 to 200 *1 |
| Four Shades (Sea area four-color display) | <p>Normally, the sea is displayed on the chart by four colors at each depth. When [Four Shades] is disabled, the sea is displayed by two colors with [Safety Contour] as a boundary.</p> <p>This item is set to clearly separate the sea into the safe area and the area where navigation requires caution.</p> <p>For the display example, refer to "(2) Example of Displaying Four Shades."</p> | To enable: Select. To disable: Clear. |

| Setting Item | Description of Setting | Setting Value |
|--|---|--|
| Shallow Pattern | Of depth that can be set at 4 levels, a lattice-like line is added to the shallow sea set in [Shallow Contour] and [Safety Contour]. This item is set to display the area where navigation requires caution conspicuously. For the display example, refer to "(3) Example of Displaying Shallow Pattern." | To enable: Select. To disable: Clear. |
| Shallow Water Dangers (Isolated obstacles in shallow water) | A dangerous route obstacle existing in the sea area that is shallower than safety contour is displayed by  mark. For the display example, refer to "(4) Example of displaying Shallow Water Dangers." | To enable: Select. To disable: Clear. |

*1: The MIN Safety Contour (Minimum value of Safety Contour that can be set) of the Own ship's parameters is used as the minimum value of the Safety Contour. For details about how to set the Own ship's parameters, refer to "17.3.4 Setting own ship's parameters".

(1) Example of displaying Shallow Contour/Safety Contour/Deep Contour

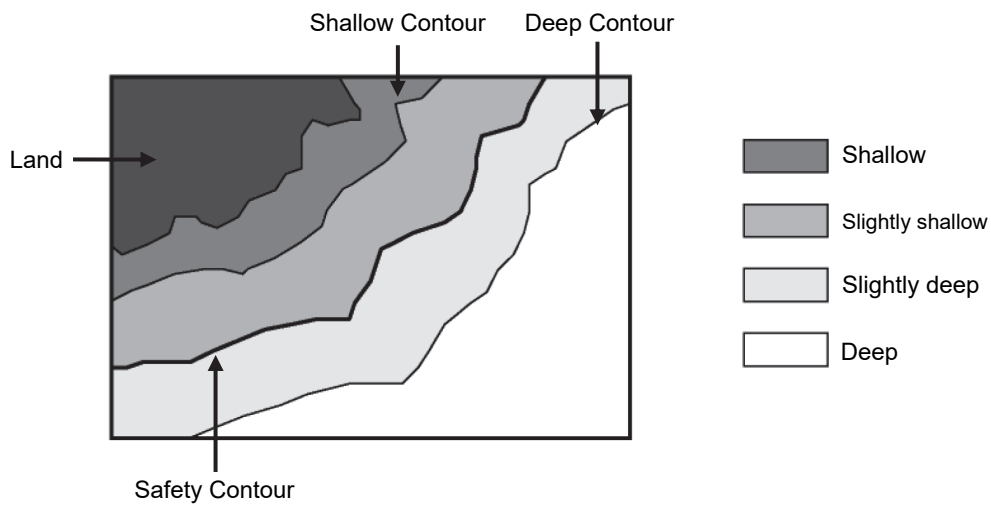

(2) Example of displaying Four Shades

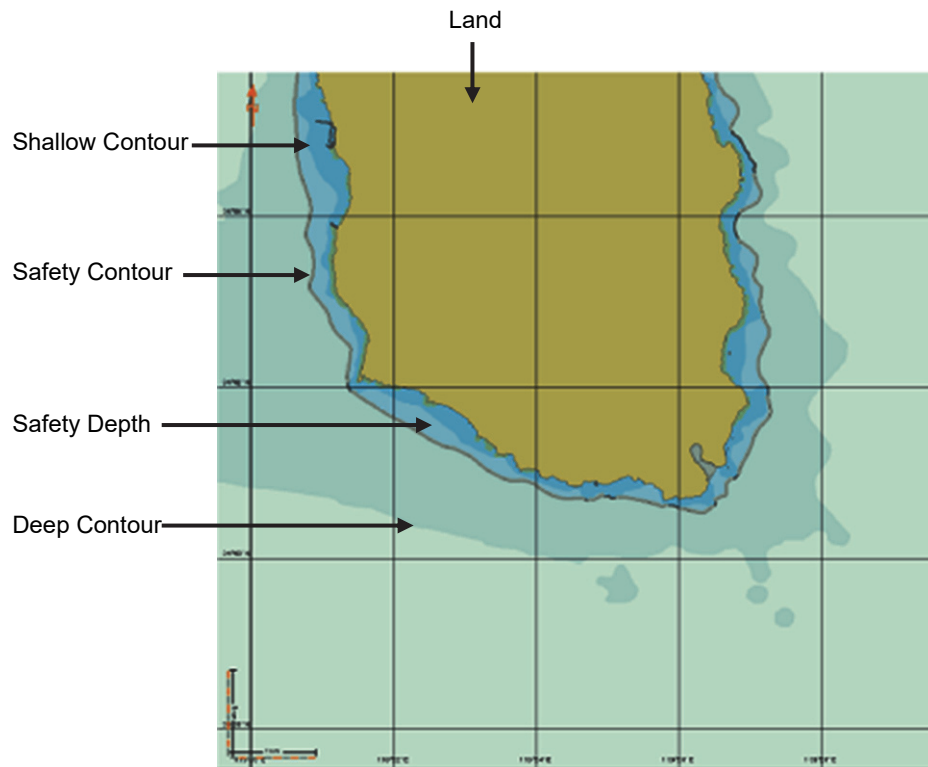

When [Four Shades] is enabled (the sea area is displayed by four colors.)

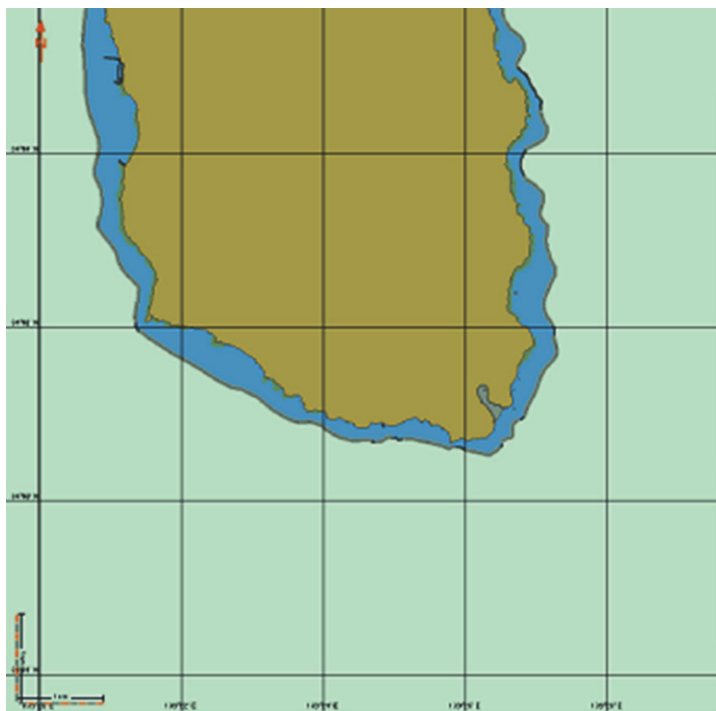

When [Four Shades] is disabled (the sea area is displayed by two colors.)

(3) Example of displaying Shallow Pattern

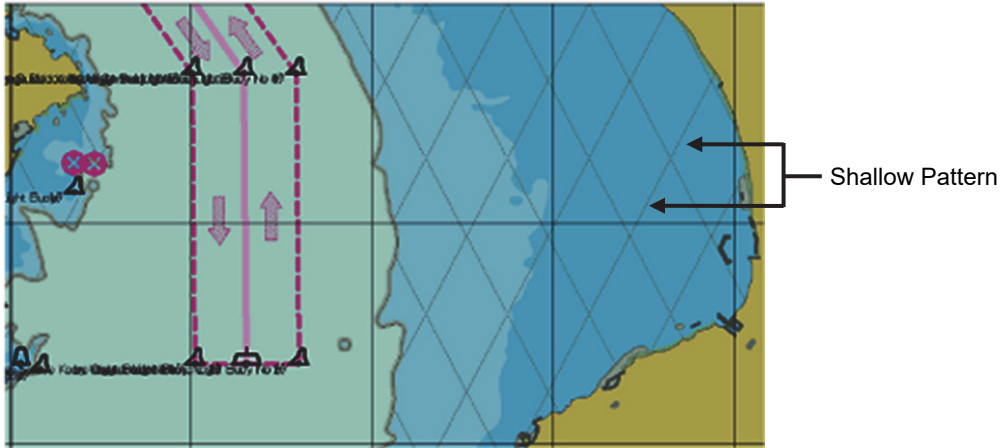

When [Shallow Pattern] is enabled (the shallow pattern is displayed)

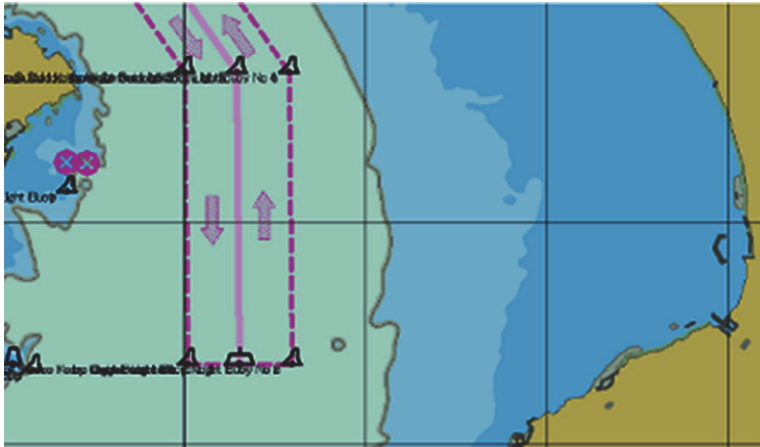

When [Shallow Pattern] is disabled (the shallow pattern is not displayed)

(4) Example of displaying Shallow Water Dangers

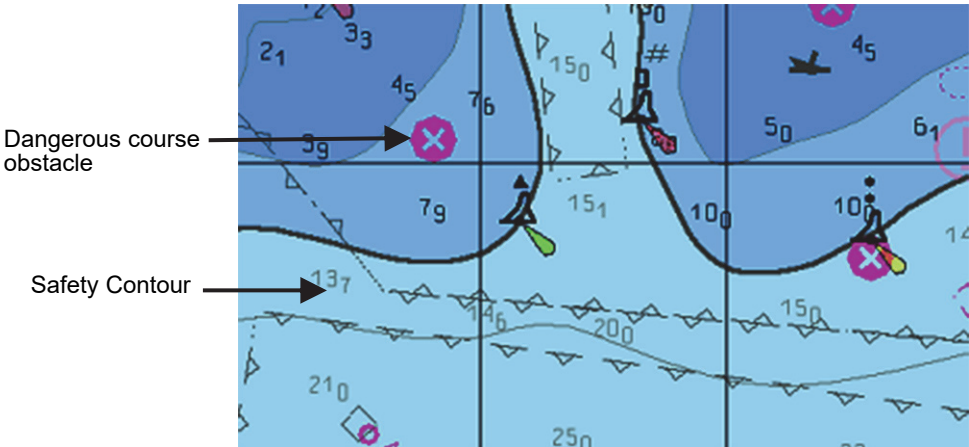

When Shallow Water Dangers is enabled

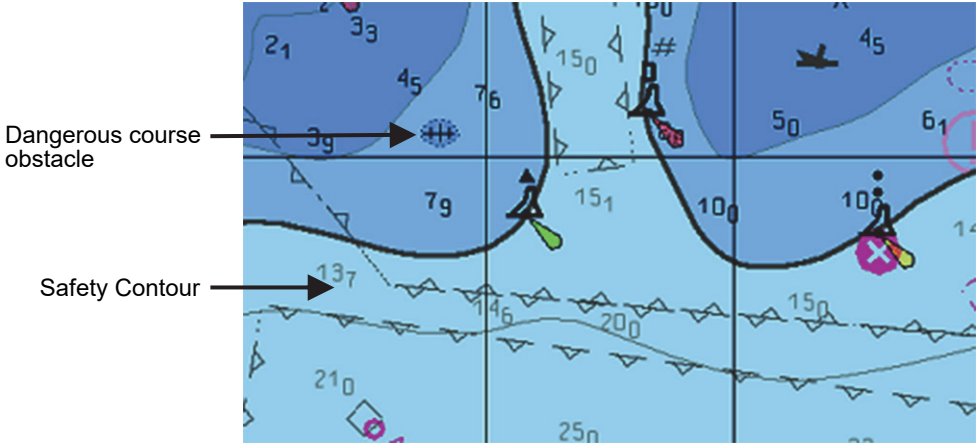

When Shallow Water Dangers is disabled

Restrictions on [Safety Contour] and [Deep Contour]

- 1) When entering in [Shallow Contour]
 - If “Safety Contour < Shallow Contour \leq Deep Contour”, the Safety Contour value is corrected to the Shallow Contour value.
 - If “Safety Depth < Shallow Contour \leq Deep Contour”, the Safety Contour is corrected to the Shallow Contour value.
 - If Safety Contour, Safety Depth \leq Deep Contour < Shallow Contour”, the Safety Contour, Safety Depth, and Deep Contour values are corrected to the Shallow Contour value.
- 2) When entering in [Deep Contour]
 - If “Shallow Contour \leq Deep Contour < Safety Contour”, the Safety Contour value is corrected to the Deep Contour value.
 - If “Shallow Contour \leq Deep Contour < Safety Depth”, the Safety Depth value is corrected to the Deep Contour value.
 - If “Deep Contour < Shallow Contour \leq Safety Contour, Safety Depth”, the Safety Contour, Safety Depth, and Shallow Contour values are corrected to the Deep Contour values.
- 3) When entering in [Safety Contour]
 - If “Shallow Contour \leq Deep Contour < Safety Contour”, the Deep Contour value is corrected to the Safety Contour value.
 - If “Safety Contour < Shallow Contour \leq Deep Contour”, the Shallow Contour value is corrected to the Safety Contour value.
- 4) When entering [Safety Depth]
 - If “Shallow Contour \leq Deep Contour < Safety Depth”, the Deep Contour value is corrected to the Safety Depth value.
 - If “Safety Depth < Shallow Contour \leq Deep Contour”, the Shallow Contour value is corrected to the Safety Depth value.

The compensated setting values are flashed temporarily.

14.2.11 Setting up the display of Chart

When you select [Chart View] in the classification pane, the [Chart View] dialog is displayed in the edit pane.

The edit pane is divided into three dialogs.

To advance to the next dialog: Click on the [Next] button.

To return to the previous dialog: Click on the [Back] button.

You can set up the same values on both the [View1] and [View2] tabs.

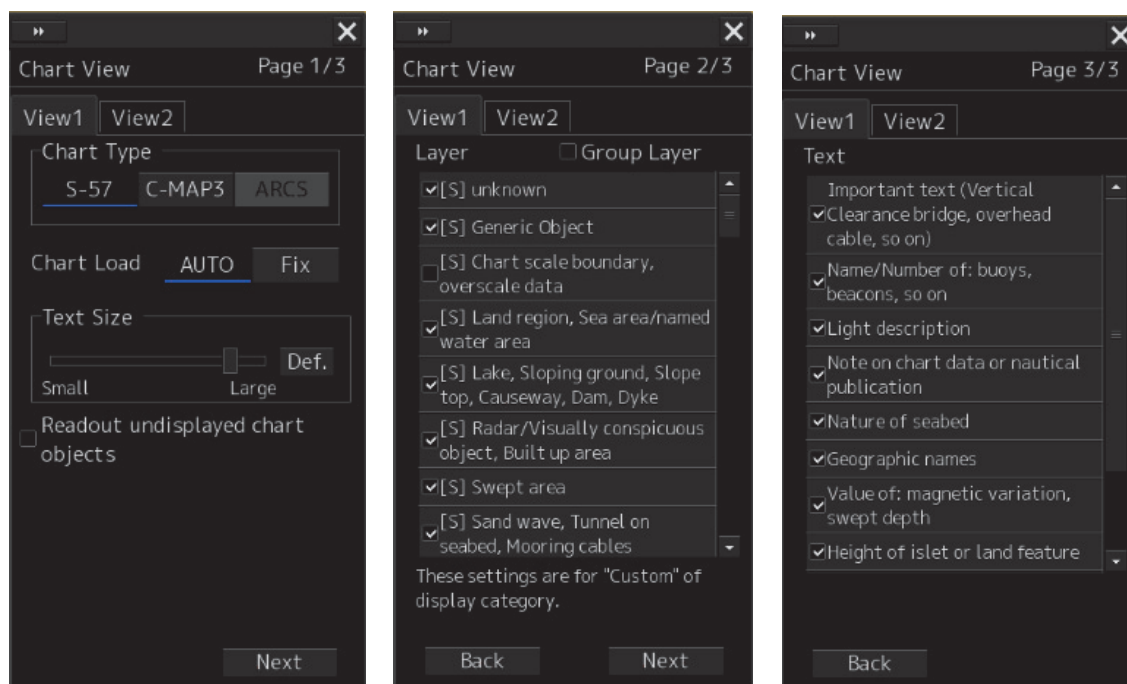

By setting the [Readout undisplayed chart objects] check box to ON or OFF in Page 1/3, it is possible to select whether the object without Viewing Group setting is displayed on the pick report. When the check box is checked, the object is displayed.

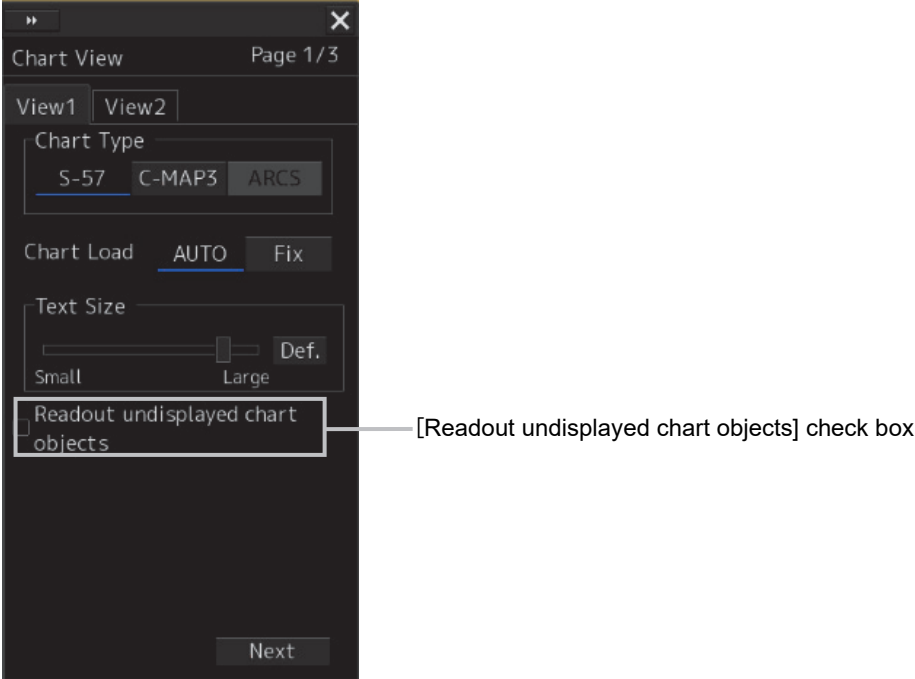

Setting a Group Layer

When the [Group Layer] check box is set to ON in Page 2/3, the Viewing Layers are grouped. The grouped lists are displayed under the main-sub layers.

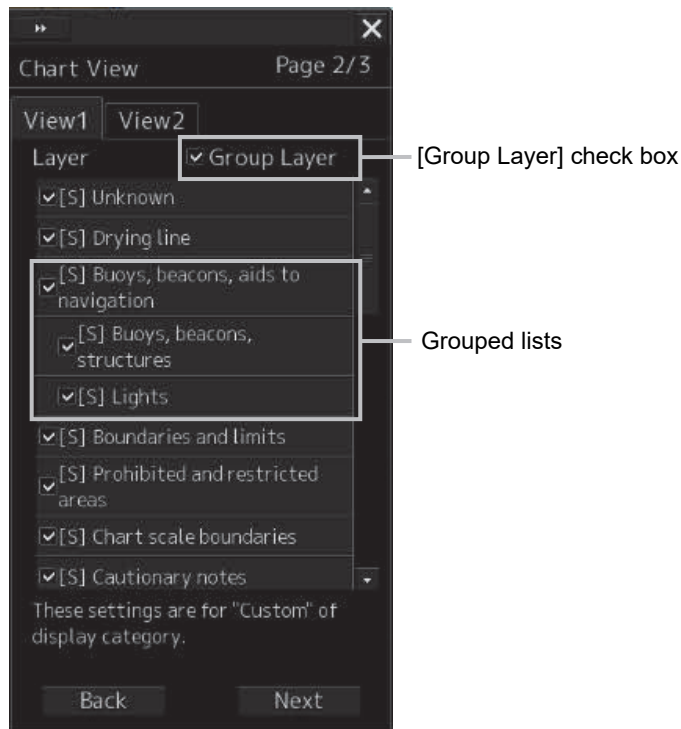

The descriptions of settings are shown in the table below.

| Setting Item | Description of Setting | Setting Value |
|--------------|---|--|
| Chart Type | Select a type of charts to be displayed by clicking on the corresponding button. S-57: Shows S-57 charts. C-Map 3: Shows C-Map Ed3 charts. ARCS: Shows ARCS charts. | S-57, C-Map 3, ARCS |
| Text Size | Drag the control on the slider and set up the text size (7 levels). Clicking on the [Def.] (Factory settings) button resets the text size to the factory preset value. For the details of the examples of changing text size, refer to "Example of changing text size". | 0 to 6 |
| Chart Load | Select a display switching mode for the S-57 chart by clicking on the button. [AUTO]: Automatically switches and shows charts. [Fix]: Fixes and shows the chart being currently displayed. | AUTO, Fix |
| Layer | When showing S-57/C-MAP charts, select the objects you want to display by selecting the check boxes of desired objects. | Refer to "Contents to be displayed as layers". |
| Text | When showing S-57/C-MAP charts, select the texts you want to display by selecting the check boxes of desired texts. | Refer to "Contents to be displayed as texts". |

Example of changing text size

Standard

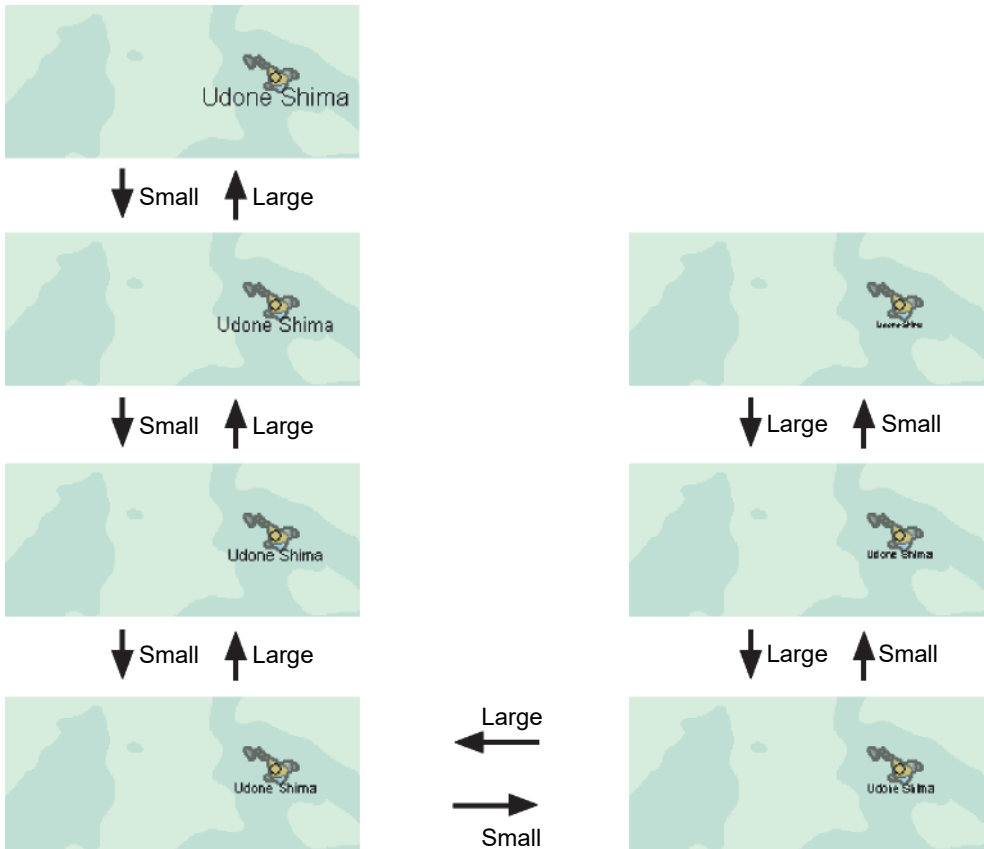

Contents to be displayed as layers

Set up the items to be displayed when the chart display category is [Custom].

There are three types of layers: [-], [S] and [A].

[-]: Items whose display categories are none of [BASE], [STD(Standard)] nor [All].

[S]: Items to be displayed when the display category is [STD].

[A]: Items to be displayed when the display category is [All].

The items that are displayed vary according to the setting of Group Layer to ON or OFF.

| Type | ENC Layer (Group Layer OFF) |
|------|--|
| [S] | Unknown |
| | Generic Object |
| | Chart scale boundary, overscale data |
| | Land region, Sea area/named water area |
| | Lake, Sloping ground, Slope top, Causeway, Dam, Dyke |
| | Radar/Visually conspicuous object, Built up area |
| | Swept area |
| | Sand wave, Tunnel on seabed, Mooring cables |
| | Navigation line |
| | Recommended track/traffic lane/route centreline |
| | Ferry route |
| | RADAR line , Limit of shore radar, Radio calling in point |
| | Restricted area |
| | Submarine transit lane, Military practice area, Sea plane landing area, Offshore production area |
| | Fairway |
| | Caution area |
| | Fishing ground, Marine farm |
| | Anchorage area, Anchor berth |
| | Dumping ground, Cargo transshipment area, Incineration area |
| | Archipelagic sea lane |
| | Buoy, Beacon, Light float, Mooring buoy, Light Vessel |
| | Daymark |
| | Distance mark |
| | Navigational system mark |
| | topmarks |
| | Gridiron |
| | light |
| | Fog signal, Retro-reflector, Radar transponder beacon, Radar reflector |
| | Pilot boarding place, Signal station, Traffic, Signal station, Warning |

| Type | ENC Layer (Group Layer OFF) |
|---------------------------------|---|
| [A] | Accuracy |
| | Nautical publication |
| | Highlight info |
| | Highlight document |
| | Highlight date dependent |
| | Coverage, Compilation scale of data |
| | Local magnetic anomaly, Magnetic variation |
| | Dunes, Hills, Ridge, Clifftop, Contours and elevation |
| | Vegetation, Lake, Rapids, River, Water fall, Tideway |
| | Building, Fortified structure, Land mark, Silo/Tank, Airport, Road, Railway |
| | Check point, Harbor facility |
| | Berth, Crane, Drydock, Mooring facility, Gate |
| | Sounding |
| | Depth counter |
| | Counter label |
| | Water turbulence |
| | Tide..., Current-non-gravitational |
| | Seabed area, Weed/Kelp, Spring |
| | Cable area, Pipeline area |
| | Obstruction, Wreck, Underwater/Awash rock |
| | Submarine cable/pipeline |
| | Continental shelf area |
| | Custom zone, Free port area, Harbour area |
| | Fishery zone |
| | Administration area, Contiguous zone, Exclusive economic zone |
| | Radar station, Radio station, Coastguard station, Rescue station |
| | Chart boundary |
| ENC edition date | |
| most recent chart update number | |
| Grid | |
| [-] | Updated Review |

| Type | C-MAP Ed.3 Layer (Group Layer OFF) |
|------|--|
| [S] | Generic Object |
| | Chart scale boundary, overscale data |
| | Land region, Sea area/named water area |
| | Lake, Sloping ground, Slope top, Causeway, Dam, Dyke |
| | Radar/Visually conspicuous object, Built up area |
| | Swept area |
| | Sand wave, Tunnel on seabed, Mooring cables |
| | Navigation line |
| | Recommended track/traffic lane/route centreline |
| | Ferry route |
| | RADAR line , Limit of shore radar, Radio calling in point |
| | Restricted area |
| | Submarine transit lane, Military practice area, Sea plane landing area, Offshore production area |
| | Fairway |
| | Caution area |
| | Fishing ground, Marine farm |
| | Anchorage area, Anchor berth |
| | Dumping ground, Cargo transshipment area, Incineration area |
| | Archipelagic sea lane |
| | Buoy, Beacon, Light float, Mooring buoy, Light Vessel |
| | Daymark |
| | Distance mark |
| | Navigational system mark |
| | Gridiron |
| | Fog signal, Retro-reflector, Radar transponder beacon, Radar reflector |
| | Pilot boarding place, Signal station, Traffic, Signal station, Warning |

| Type | C-MAP Ed.3 Layer (Group Layer OFF) |
|------|---|
| [A] | Accuracy |
| | Nautical publication |
| | Coverage, Compilation scale of data |
| | Local magnetic anomaly, Magnetic variation |
| | Dunes, Hills, Ridge, Cliff-top, Contours and elevation |
| | Vegetation, Lake, Rapids, River, Water fall, Tideway |
| | Building, Fortified structure, Land mark, Silo/Tank, Airport, Road, Railway |
| | Check point, Harbor facility |
| | Berth, Crane, Drydock, Mooring facility, Gate |
| | Sounding |
| | Depth counter |
| | Counter label |
| | Water turbulence |
| | Tide..., Current-non-gravitational |
| | Seabed area, Weed/Kelp, Spring |
| | Cable area, Pipeline area |
| | Obstruction, Wreck, Underwater/Awash rock |
| | Submarine cable/pipeline |
| | Continental shelf area |
| | Custom zone, Free port area, Harbor area |
| | Fishery zone |
| | Administration area, Contiguous zone, Exclusive economic zone |
| | Radar station, Radio station, Coastguard station, Rescue station |
| | Chart boundary |
| Grid | |

| Type | ENC Layer (Group Layer ON) |
|------|--|
| [S] | Unknown |
| | Drying line |
| | Buoys, beacons, aids to navigation |
| | Buoys, beacons, structures |
| | Lights |
| | Boundaries and limits |
| | Prohibited and restricted areas |
| | Chart scale boundaries |
| | Cautionary notes |
| | Ships' routing ¹ systems and ferry routes |
| | Archipelagic sea lanes |
| | Miscellaneous |

¹ routing: UK notation

| Type | ENC Layer (Group Layer ON) |
|---------------------------------|--------------------------------|
| [A] | Accuracy |
| | Highlight date dependent |
| | Highlight info |
| | Highlight document |
| | Counter label |
| | Spot soundings |
| | Submarine cables and pipelines |
| | All isolated dangers |
| | Magnetic variation |
| | Depth counter |
| | Seabed |
| | Tidal |
| | Miscellaneous |
| | Chart boundary |
| | ENC edition date |
| most recent chart update number | |
| Grid | |
| [-] | Update Review |

| Type | C-MAP Ed.3 Layer (Group Layer ON) |
|------|--|
| [S] | Drying line |
| | Buoys, beacons, aids to navigation |
| | Buoys, beacons, structures |
| | Boundaries and limits |
| | Prohibited and restricted areas |
| | Chart scale boundaries |
| | Cautionary notes |
| | Ships' routing ² systems and ferry routes |
| | Archipelagic sea lanes |
| | Miscellaneous |

² routing: UK notation

| Type | C-MAP Ed.3 Layer (Group Layer ON) |
|------|-----------------------------------|
| [A] | Accuracy |
| | Counter label |
| | Spot soundings |
| | Submarine cables and pipelines |
| | All isolated dangers |
| | Magnetic variation |
| | Depth counter |
| | Seabed |
| | Tidal |
| | Miscellaneous |
| | Chart boundary |
| | Grid |

Contents to be displayed as texts

| ENC Text (Group Layer OFF) |
|---|
| Important text (Vertical Clearance bridge, overhead cable, so on) |
| Name/Number of: buoys, beacons, so on |
| Light description |
| Note on chart data or nautical publication |
| Nature of seabed |
| Geographic names |
| Value of: magnetic variation, swept depth |
| Height of islet or land feature |
| Berth number |
| Current velocity |
| National language |

| C-MAP Ed.3 Text (Group Layer OFF) |
|--|
| Important text(Vertical Clearance bridge, overhead cable, so on) |
| Other text (Name of building so on) |
| Light description |
| Note on chart data or nautical publication |
| Geographic names |
| National language |

| ENC Text (Group Layer ON) |
|---------------------------|
| Important text |
| Other text |
| Names |
| Light description |
| All other |
| National language |

| C-MAP Ed.3 Text (Group Layer ON) |
|----------------------------------|
| Important text |
| Other text |
| Names |
| Light description |
| All other |
| National language |

14.2.12 Setting up AIO display

When you select [AIO] in the classification pane, the [AIO] dialog box appears in the edit pane.

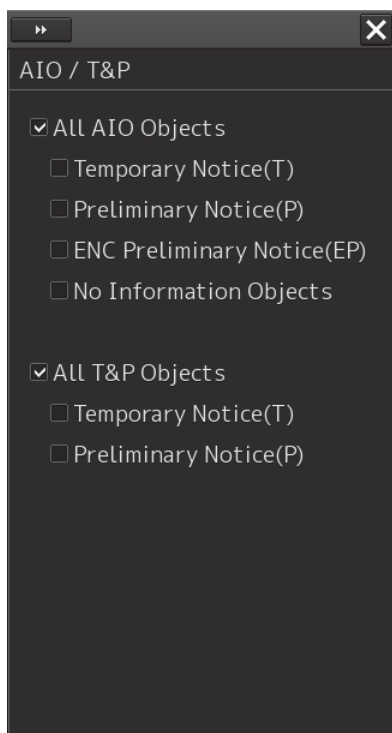

The descriptions of settings are shown in the table below.

| Setting Item | Description of Setting | Setting Value |
|-----------------------------|--|--|
| All AIO Objects | Select and enable the display of all AIO objects. | To enable: Select. To disable: Clear. |
| Temporary Notice (T) | Select and enable the display associated with Temporary Notice (T). | To enable: Select. To disable: Clear. |
| Preliminary Notice (P) | Select and enable the display associated with Preliminary Notice (P). | To enable: Select. To disable: Clear. |
| ENC Preliminary Notice (EP) | Select and enable the display associated with ENC Preliminary Notice (EP). | To enable: Select. To disable: Clear. |
| No Information Objects | Select and enable the display associated with No Information Objects. | To enable: Select. To disable: Clear. |
| All T&P Objects | Select and enable the display of all T&P objects | To enable: Select. To disable: Clear. |
| Temporary Notice (T) | Select and enable the display associated with Temporary Notice (T). | To enable: Select. To disable: Clear. |
| Preliminary Notice (P) | Select and enable the display associated with Preliminary Notice (P). | To enable: Select. To disable: Clear. |

Note

T&P will not be displayed if the display scale is a small scale of more than 1 / 20,000,000.

14.2.13 Set display of danger detection highlight

When you select [Graphical Indication] in the classification pane, the [Graphical Indication] dialog box appears in the edit pane.

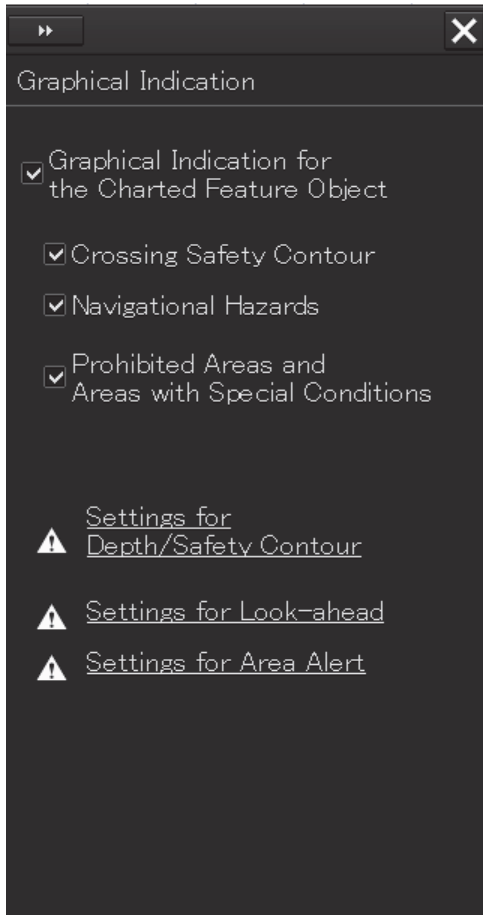

The descriptions of settings are shown in the table below.

| Setting Item | Description of Setting | Setting Value |
|---|---|--|
| Graphical Indication for the Charted Feature object | Select and enable the highlighting function of the detection object on the chart | To enable: Select. To disable: Clear. |
| Crossing Safety Contour | Activate the partial highlight display function of the object where the execution result of Safety Check becomes Crossing Safety Contour error. | To enable: Select. To disable: Clear. |
| Navigational Hazards | Activate the partial highlight display function of the object where the execution result of Safety Check becomes Navigational Hazards error. | To enable: Select. To disable: Clear. |
| Prohibited Areas and Areas with Special Conditions | Prohibited Area or Areas with Special Condition activates the partial highlighting function of the error part. | To enable: Select. To disable: Clear. |
| Settings for Depth/Safety Contour | Click to open the Depth / Safety Contour screen of the Alert setting. | |
| Settings for Vector/Sector | Click to open the Vector/Sector screen of the Alert setting. | |
| Settings for Area Alert | Click to open the Area Alert screen of the Alert setting. | |

14.2.14 Setting up the display of Range/Bearing Measurement Function

When you select [Tools] in the classification pane, the [Tools] dialog is displayed in the edit pane.

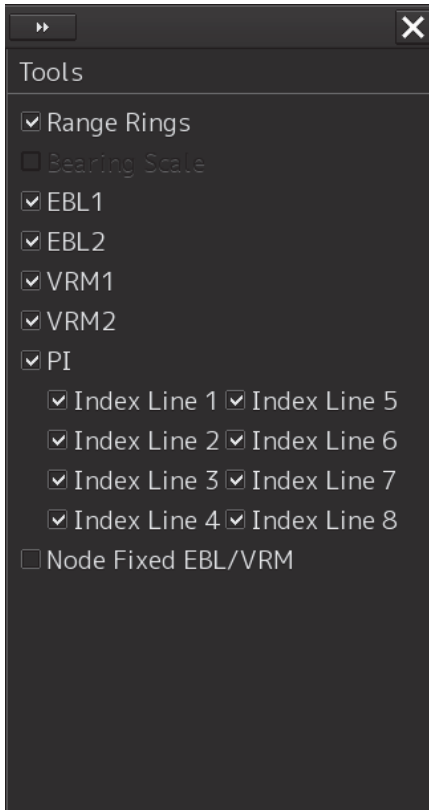

The descriptions of settings are shown in the table below.

| Setting Item | Description of Setting | Setting Value |
|---------------------------|--|---|
| Range Rings | Selecting this enables to display range rings. | To enable: Select. To disable: Clear. |
| Bearing Scale | Selecting this enables to display the bearing scale. Note This item is displayed on the ECDIS screen only. This item is enabled only when overlay is set to On. | To enable: Select. To disable: Clear. |
| EBL1/EBL2 | Selecting this enables to display the EBL1/EBL2 markers. | To enable: Select. To disable: Clear. |
| VRM1/VRM2 | Selecting this enables to display the VRM1/VRM2 markers. | To enable: Select. To disable: Clear. |
| PI (parallel line cursor) | Select this to enable to display the PI cursors, and then select the PI cursors you want to display by selecting them. | To enable: Select. To disable: Clear. PI cursor selections Index Line 1 to Index Line 8 |
| Node Fixed EBL/VRM | Selecting this enables to display the node fixed EBL/VRM. | To enable: Select. To disable: Clear. |

14.2.15 Setting up the display of unit of setting value

Note

Some items may not be displayed depending on the installation setting.

When you select [Unit] in the classification pane, the [Unit] dialog is displayed in the edit pane.



The descriptions of settings are shown in the table below.

| Setting Item | Description of Setting | Setting Value |
|-----------------------|--|------------------------|
| Depth (water depth) | Select a unit of water depth from the combo box. | m, ft, fm |
| Ship Speed | Select a unit of the ship speed from the combo box. | kn, m/s, km/h |
| Current Speed | Select a unit of the current speed from the combo box. | kn, m/s, km/h |
| Wind Speed | Select a unit of the wind speed from the combo box. | kn, m/s, km/h |
| Propeller Revolution | Select a unit of the propeller's revolution per minute from the combo box. | rpm, min ⁻¹ |
| Propeller Pitch Angle | Select a unit of the propeller's pitch angle from the combo box. | °, % |
| Thruster Revolution | Select the unit of thruster revolution from the combo box. | rpm, min ⁻¹ |
| Thruster Pitch Angle | Select a unit of the thruster's pitch angle from the combo box. | °, %, NOTCH |
| Air TEMP | Select a unit of the air temperature from the combo box. | °C, °F |
| Water TEMP | Select a unit of the water temperature from the combo box. | °C, °F |
| Air Pressure | Select a unit of the air pressure from the combo box. | hPa, mbar |
| Wind Direction(True) | Select a wind direction (true) display method from the combo box. | 16 points, Degree |

14.2.16 Setting up display of Own Ship Track Control, display format of Own Ship/Cursor Position and display of Sub-Information dialog

When you select [Control] in the classification pane, the [Control] dialog is displayed in the edit pane.

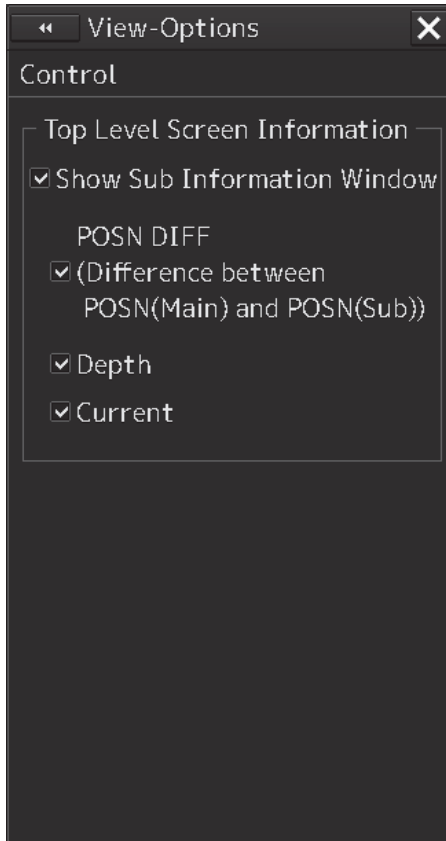

The descriptions of settings are shown in the table below.

| Setting Item | Description of Setting | Setting Value |
|--|---|--|
| Show Sub Information Window (sub information dialog box display) | <p>Select this to enable to display the sub information dialog box, and then select the tab(s) you want to display.</p> <p>Note</p> <ul style="list-style-type: none"> The [Depth] tab can only be selected when equipped with a water depth sensor. The [Current] tab can only be selected when equipped with a GPS, a gyro and a log sensor. | <p>To enable: Select. To disable: Clear.</p> <p>Tab selections POSN DIFF(Difference between POSN(Main) and POSN(Sub)), Depth, Current</p> |

14.2.17 Setting up the Water Depth display

When [Depth Graph] is selected on the classification pain, the [Depth Graph] dialog is shown on the Edit pain.

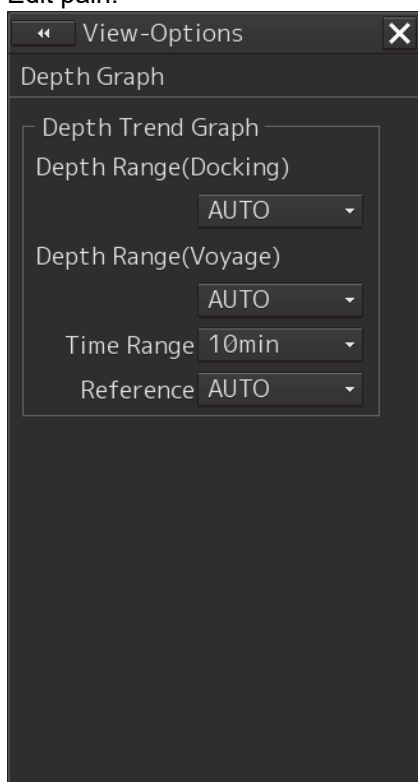

The following table shows the setting details:

| Setting item | Description | Setting values |
|----------------------|--|--|
| Depth Range(Docking) | Select a depth range for the docking depth graph from the combo box. | AUTO, 10 m, 25 m, 50 m |
| Depth Range(Voyage) | Select a depth range for the route depth graph from the combo box. | AUTO, 50 m, 100 m, 250 m |
| Time Range | Select a time range for the depth graph from the combo box. | 10 min, 15 min, 30 min, 60 min, 12 hours |
| Reference | Select a reference for depth display from the combo box. | AUTO, Keel |

14.2.18 Setting up the Rudder graph

When [Rudder Graph] is selected on the classification pain, the [Rudder Graph] dialog is displayed on the edit pain.

Note

This dialog may not be displayed depending on the equipment setting.



The following table shows the setting details:

| Setting item | Setting | Setting value |
|--------------|--|-------------------------------|
| Time Range | Select a time range for the Rudder graph from the combo box. | 5 min, 10 min, 15 min, 30 min |
| Rudder Range | Select a rudder angle for the Rudder graph from the combo box. | 30°, 40°, 50°, 60°, 70°, 80° |

14.2.19 Setting up the Gyro/Rudder graph

When [Gyro/Rudder Graph] is selected on the classification pain, the [Gyro/Rudder Graph] dialog is displayed on the edit pain.

Note

This dialog may not be displayed depending on the equipment setting.



The following table shows the setting details:

| Setting item | Setting | Setting value |
|--------------|---|-------------------------------|
| Time Range | Select a time range for the Gyro/Rudder graph from the combo box. | 5 min, 10 min, 15 min, 30 min |
| Rudder Range | Select a rudder angle for the Gyro/Rudder graph from the combo box. | 30°, 40°, 50°, 60°, 70°, 80° |

14.2.20 Setting up the Engine Graph

When [Engine Graph] is selected on the classification pain, the [Engine Graph] dialog is displayed on the edit pain.

Note

This dialog may not be displayed depending on the equipment setting.

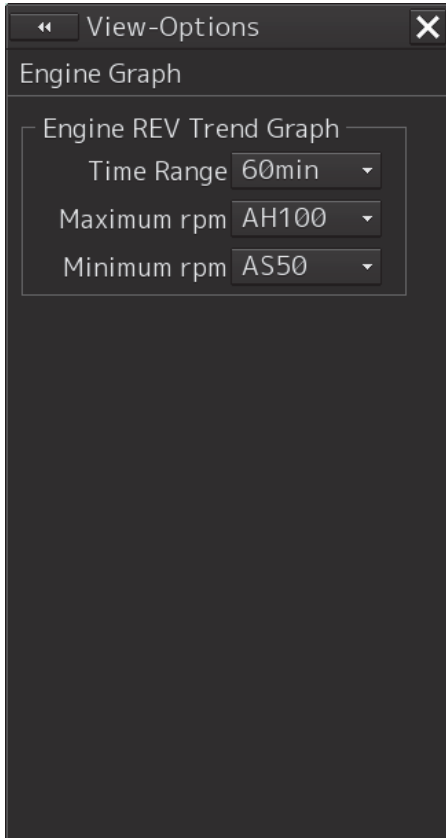

The following table shows the setting details:

| Setting item | Setting | Setting value |
|--------------|--|------------------------------------|
| Time Range | Select a time range for the engine speed graph form the combo box. | 10 min, 15 min, 30 min, 60 min |
| Maximum rpm | Select an engine speed on the Ahead side form the combo box. | AH100, AH200, AH300, AH500, AH1000 |
| Minimum rpm | Select an engine speed on the Astern side form the combo box. | 0, AS50, AS100 |

14.2.21 Setting up the graph range of the ROT slide bar

When [ROT] is selected on the classification pain, the [ROT] dialog is displayed on the edit pain.

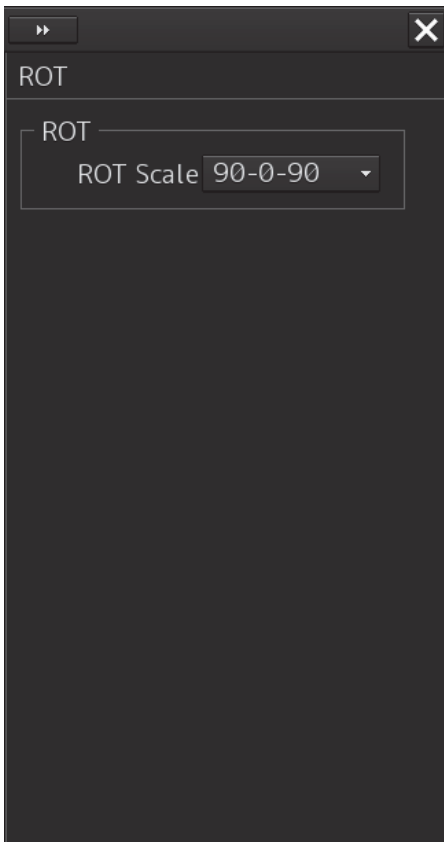

| Setting item | Setting | Setting value |
|--------------|--|--|
| ROT Scale | Select a graph range for the ROT slide bar from the combo box. | 30-0-30, 60-0-60, 90-0-90, 120-0-120, 150-0-150, 300-0-300 |



Section 15 Setting up Alerts

By setting this equipment to generate an alert when the own ship's position or the condition meets the specific condition or any other ship or obstacle approaches to a specific range, preliminary measures can be taken, avoiding collisions, grounding, and deviation from the route can be avoided.

This section explains the method of setting conditions (threshold values) for generating alerts, alert processing operations, and alert timer setting using the [Alert] menu.

15.1 Selecting Setting Items

When the [Alert] menu is opened, the [Alert] dialog box appears.

By selecting a setting item in the [Alert] dialog box, the setting dialog of the selected item can be displayed.

15.1.1 Displaying the [Alert] dialog box

- 1 Click on the [Menu] button on the left toolbar.



The menu is displayed.

- 2 Click on the [Alert] button on the menu.

The [Alert] dialog box appears.



The [Alert] dialog box consists of the classification pane and the edit pane.

By clicking the Disclosure button (), you can hide the classification pane. To show the classification pane again, click the Disclosure button ().

15.1.2 Selecting a setting item

1 Click the alert classification you want to set up in the classification pane.

The setting dialog of the selected item is displayed in the edit pane.

2 Set up in the edit pane.

The following items can be set in the [Alert] dialog box.

| Setting item | Setting contents |
|---|---|
| New Target Warning | Set the following conditions to automatically activate the target. (No alert will be generated even if the target is automatically activated.) <ul style="list-style-type: none">• Area (AZ) for tracked target automatic activation• Enable/disable AZ Refer to "15.2 Target Automatic Activation Conditions". |
| Depth/Safety Contour | Set the following conditions to generate a grounding avoidance alert. <ul style="list-style-type: none">• Safety contour line approach alarm Refer to "15.3 Depth/Safety Contour Alert Generation Conditions". |
| Look-ahead (Forward forecast monitoring) | Set a forward forecast monitoring. Refer to "15.4 Setting up Look Ahead". |
| Special Condition Area | Set the conditions for generating a warning by detecting a danger detection vector. Refer to "15.5 Area Alert Generation Conditions". |
| Track Control | Set the conditions for generating an automatic route retention alert. Refer to "15.6 Track Control Alert Generation Conditions". |
| Position Integrity (Position sensor integrity) | Set the conditions for generating POSN(Deviation) warning, POSN(Jump) caution and HDOP exceeded Maintenance Information. Refer to "15.7 Position Integrity Alert Generation Conditions". |
| CAM (Central Alert Management) | Set the actions to be taken at the next stage for an unacknowledged alert. Refer to "15.8 Setting up Alert Processing". |

15.2 Target Automatic Activation Conditions

When you select [New Target Warning] in the classification pane, the [New Target Warning] dialog is displayed in the edit pane.

In this dialog, it is possible to set the AZ (automatic/activation zone) and switch the AZ to enable/disable.

For the details of the setting of the AZ, refer to "5.2.3 Setting up the automatic/activation zone (AZ)".

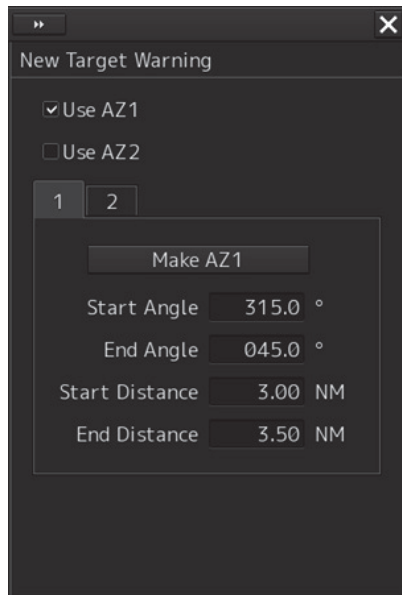

Settings of AZ1
(Automatic/Activation Area 1)

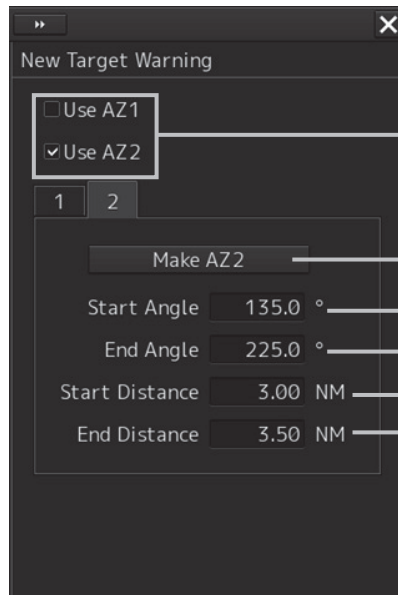

Settings of AZ2
(Automatic/Activation Area 2)

When one of these is selected, AZ1 or AZ2 takes effect.

When this is clicked on, the cursor mode is set to a Make AZ mode.

Enter the start angle.

Enter the end angle.

Enter the start distance.

Enter the end distance.

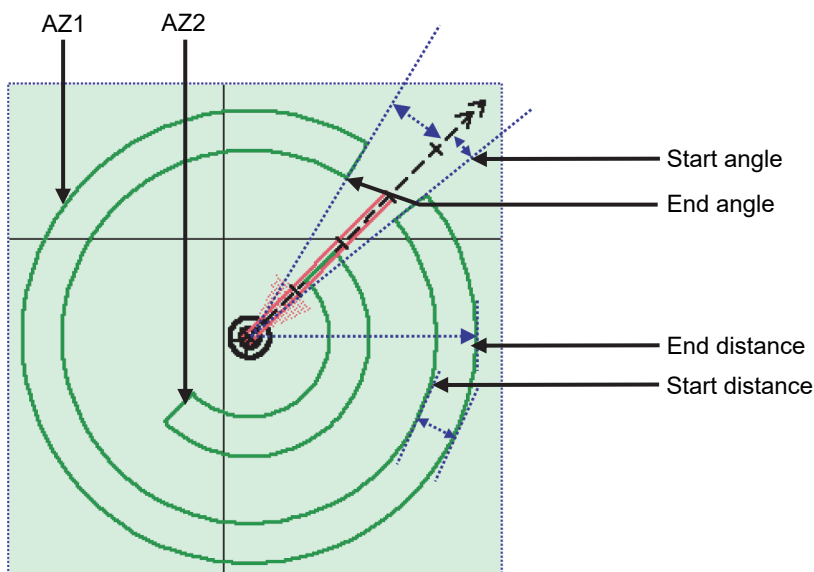

15.2.1 Switching AZ1/AZ2 to enable/disable

15.2.1.1 Enabling AZ1 or AZ2

Select the [Use AZ1] or [Use AZ2] check box.

The AIS target in the AZ will be automatically activated and become a target of collision detection.

The vector is displayed after the AIS target's activation.

15.2.1.2 Disabling AZ1 or AZ2

Clear the [Use AZ1] or [Use AZ2] check box.

The activation area disappears from the screen. However, the AIS target is still activated.

15.3 Depth/Safety Contour Alert Generation Conditions

When [Depth/Safety Contour] is selected in the classification pane, the [Depth/Safety Contour] dialog is displayed in the edit pane.

In this dialog, the threshold values for generating "Crossing safety contour alarm" can be set up.

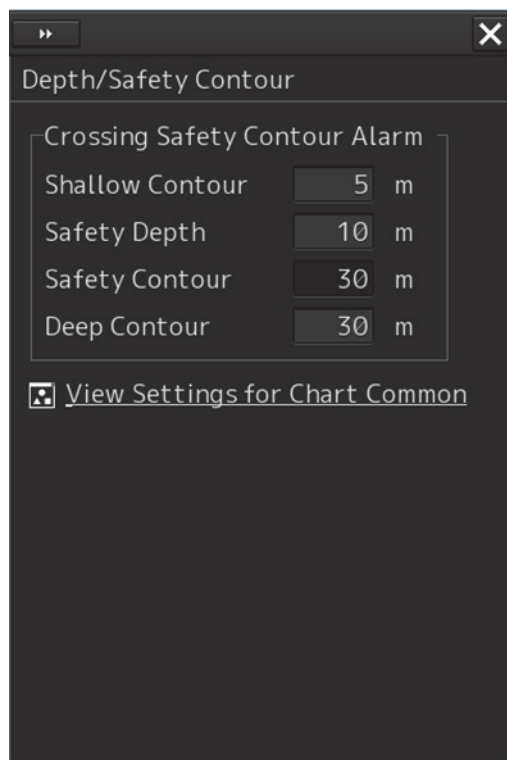

Each threshold value can be set in a range between 0 and 200 m.

In the [Shallow contour], [Safety depth] and [Deep contour] input boxes, the values set in [Options] - [Chart Common] of the View menu are displayed.

When [View Settings for Chart Common] is clicked, the [Chart Common] dialog box of the View menu appears.

For the details of each setting item, refer to "14.2.9 Setting up the Display of Chart Common".

- Shallow Contour
- Safety Depth
- Safety Contour
- Deep Contour

Automatic compensation of entered values

The threshold values must satisfy the following conditions.

- Shallow Contour \leq Safety Contour \leq Deep Contour
- Shallow Contour \leq Safety Depth \leq Deep Contour

Safety Contour and Safety Depth are not related.

If there is any contradiction in the entered values, the following automatic compensations will be performed.

| Condition | Compensation |
|--|---|
| Safety contour value (or Safety Depth value) < Shallow contour value | Replace the Shallow contour value with the Safety contour value (or Safety Depth value) |
| Deep contour value < Safety contour value (or Safety Depth value) | Replace the Deep contour value with the Safety contour value (or Safety Depth value) |

15.4 Setting up Look Ahead

When [Look Ahead] is selected in the classification pane, the [Look Ahead] dialog is displayed in the edit pane.

In this dialog, the selection of the sizes of both a danger detection vector/sector and the switching to enable/disable of them are possible.



15

This unit can monitor when own ship tries to cross over the preset safety contour or danger area, or when dangerous objects enter the sector specified around own ship. For this monitoring, danger detection vectors and sectors can be displayed. As for danger detection vectors, detection ranges for crossover of safety contours and danger areas can be specified in units of minutes or nautical miles, and notches on vectors and tips of vectors indicate predicted positions if navigated at the current speed. Also, the radius of a sector can be set up in units of miles or minutes.

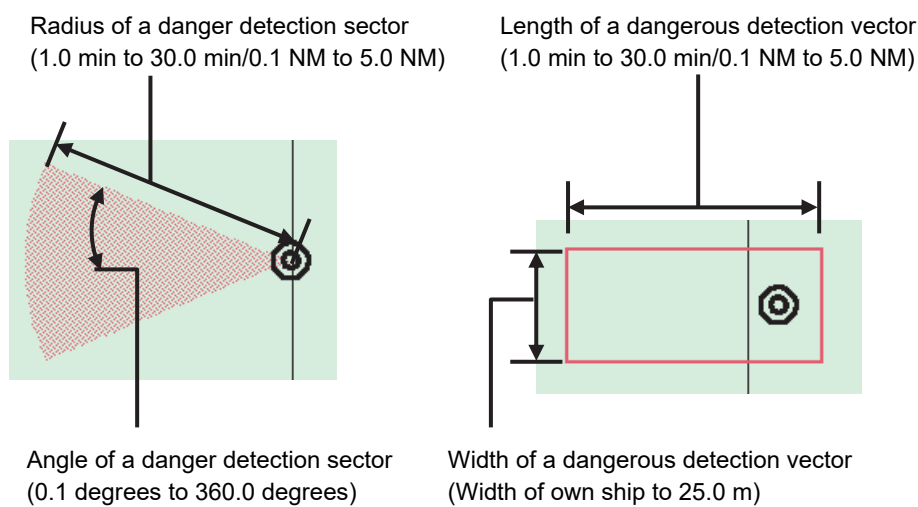

Dangerous Detection Vector and Sector

15.4.1 Switching to enable/disable a danger detection vector/sector

To enable a danger detection vector/sector, select [Use Area(Rectangle)] and/or [Use Area(Sector)] check box.

A danger detection vector and a danger detection sector appear on the chart.

To disable a danger detection vector/sector, clear [Use Area(Rectangle)] and/or [Use Area(Sector)] check box.

A danger detection vector and a danger detection sector disappear from the chart.

15.4.2 Setting up the size of a danger detection vector

1 Enter a value in [Length].

Specify it in a range between 1.0 and 30.0 min or between 0.1 and 5.0 NM.

The unit of the vector length can be switched between min and NM by clicking on the Change Unit button,

2 Enter a value in [Width].

Specify the vector width in a range between own ship's beam and 250.0 m.

15.4.3 Setting up the size of a danger detection sector

1 Enter a value in [Sector Radius].

Specify it in a range between 1 and 30 min or between 0.1 and 5.0 NM.

The unit of the sector radius can be switched between min and NM by clicking on the Change Unit button,

2 Enter a value in [Sector Width].

Specify the sector width in a range between 0.1 and 360.0°.

15.5 Area Alert Generation Conditions

When [Area Alert] is selected in the classification pane, the [Area Alert] dialog is displayed. In this dialog, set an area for generating a warning when the symbol on the chart touches the danger detection vector.

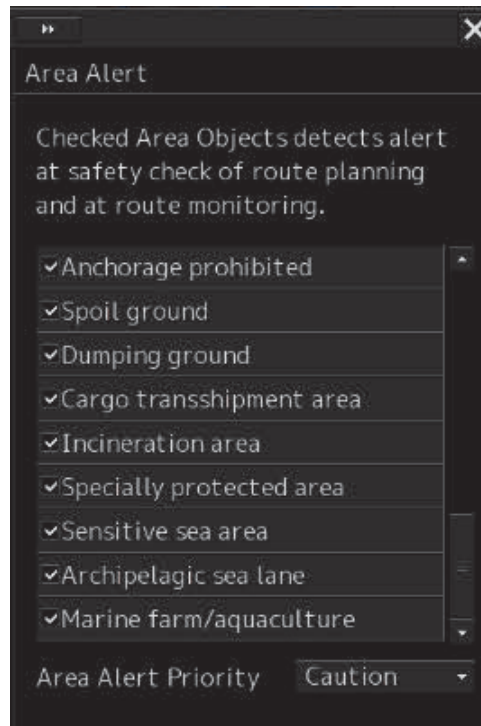
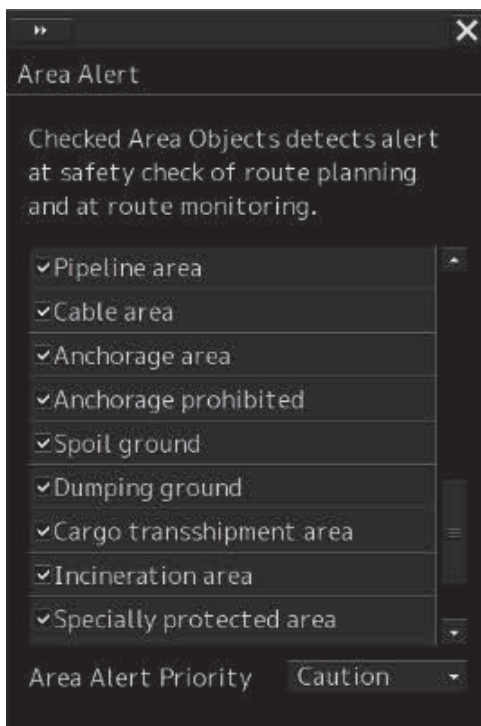
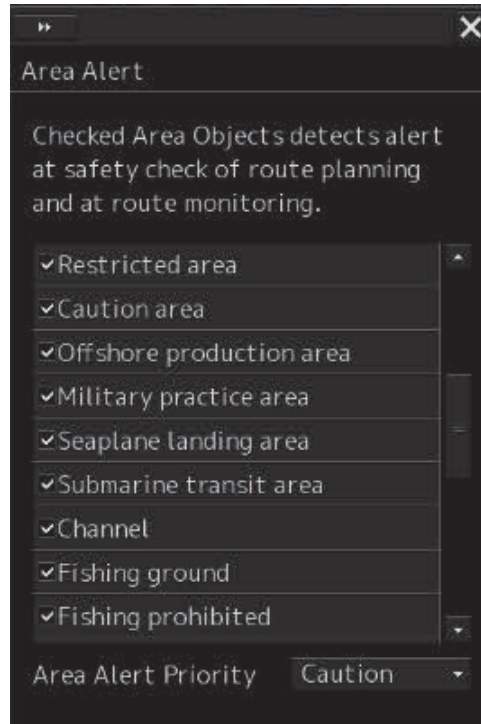
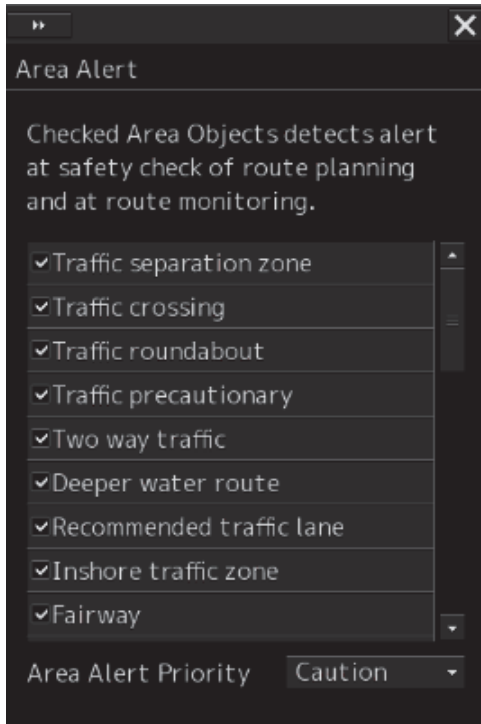

Select the check box of the area that is targeted for the alarm.
Clear the check box of the area not to be targeted for the alarm.

When you select Warning or Caution in the **Area Alert Priority combo box**, the alert priority is set at once.

If priority is changed during alert occurrence, it will be regenerated.

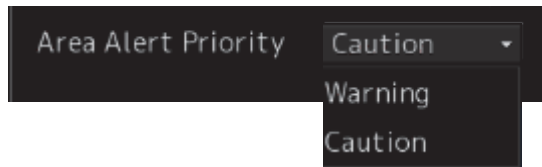

15.6 Track Control Alert Generation Conditions

Note

In case of JAN-7201S/9201S, automatic sailing function is not available by function restriction. Therefore the setup is not available.

When [Track Control] is selected in the classification pane, the [Track Control] dialog is displayed. In this dialog, the conditions for generating warnings regarding Course Difference Limit, End of Track Limit, and ECC Limit can be set up.

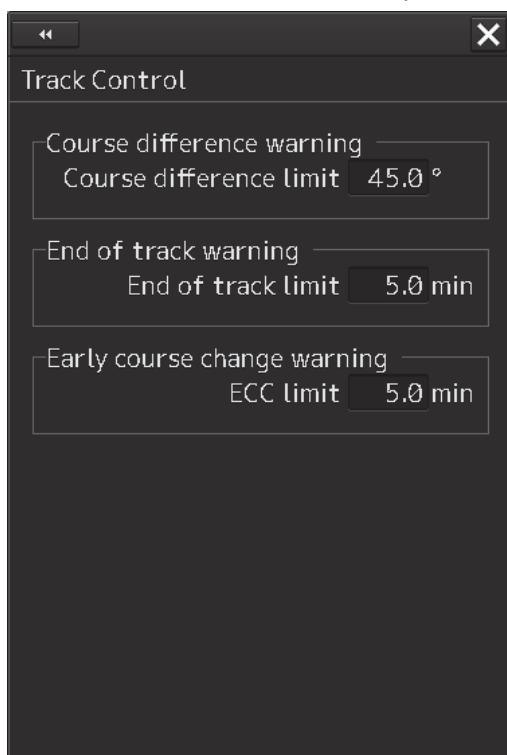

Enter a threshold value for generating each warning.

Course difference limit:

Specify the difference between the planned course and own ship's bearing in angle, within a range between 0.5 and 45.0°.

End of track limit:

Specify the time remaining to reach the destination so as to generate an alert for approaching to the proximity of the final destination in a range between 3.0 to 6.0 min.

Memo

If "End Of Track" warning is not acknowledged for 30 seconds, the warning escalates to "Arrived at LAST WPT" alarm.

ECC limit:

Specify the time remaining to reach the wheel over point so as to generate an early course change warning in a range between 3.0 and 6.0 min.

Memo

If "Early course change" warning is not acknowledged for 30 seconds, the warning escalates to "Early course change" alarm.

15.7 Position Integrity Alert Generation Conditions

When [Position Integrity] is selected in the classification pane, the [Position] dialog is displayed. In this dialog, the generation condition of POSN(Deviation) warning, POSN(Jump) caution and HDOP exceeded Maintenance Information can be set up.

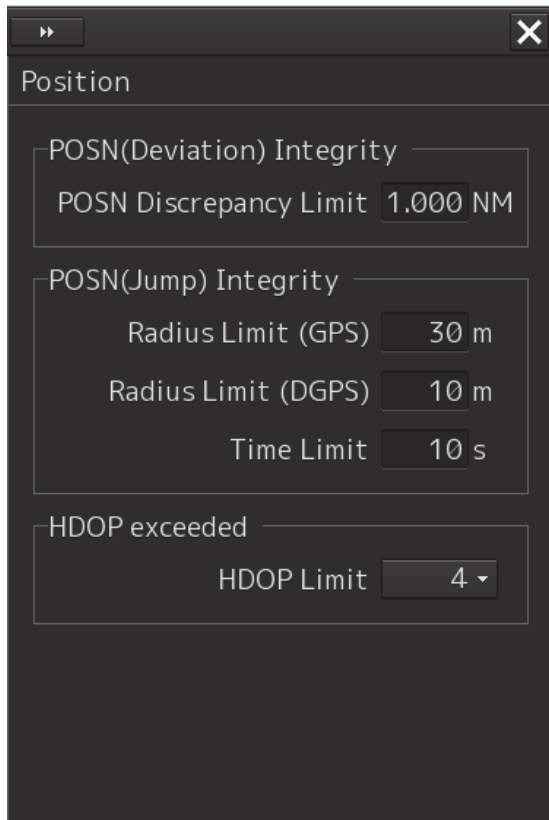

15.7.1 Setting up the generation condition of the POSN(Deviation) warning

Enter the following threshold values for generating the POSN(Deviation) warning.

Position Discrepancy Limit:

The difference in distances when two GPS positions are compared at every second is used as a threshold value. Specify the difference in a range between 0.010 and 9.990 NM.

Note

Position Discrepancy Limit takes effect when two GPSs are installed.

15.7.2 Setting up the generation condition of the POSN(Jump) caution

Radius Limit (GPS):

The radius of a monitoring circle having the predicted position of a GPS 1 sec later at the center is used as a threshold value. If the position actually measured is not within the time monitoring circle specified in [Time Limit], it will be subjected to an alert. Specify the radius limit in a range between 10 and 100 m.

Radius Limit (DGPS):

The radius of a monitoring circle having the predicted position of DGPS 1 sec later at the center is used as a threshold value. If the position actually measured is not within the time monitoring circle specified in [Time Limit], it will be subjected to an alert. Specify the radius limit in a range between 10 and 100 m.

Time Limit:

The time during which the position actually measured by a GPS/DGPS deviates from the monitoring circle is used as a threshold value. The time limit can be specified in a range between 1 and 29s.

15.7.3 Setting up the generation condition of the HDOP exceeded Maintenance Information

In the [HDOP Limit] combo box, select a threshold limit of HDOP (Horizontal Dilution of Precision). Select either one of [4], [10] and [20].

15.8 Setting up Alert Processing

When [CAM] is selected in the classification pane, the [CAM] dialog is displayed on the edit pane. In this dialog, the time to activate the action at the next stage when acknowledge is not performed for an alert can be set up.

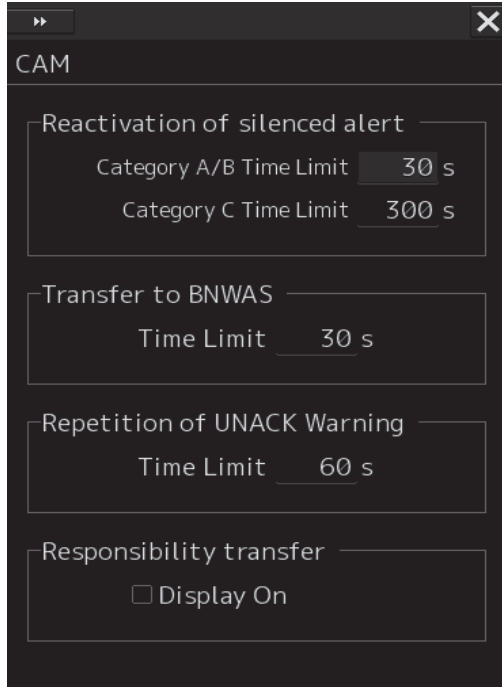

Enter the wait time until an alert at the next stage is generated in [Time Limit].

Reactivation of Silenced Alert:

Category A/B Time Limit: 30 seconds.

Category C Time Limit: Set, within the range from 0 to 300s, the time required to reactivate the alert sound that was silenced temporarily.

Transfer to BNWAS:

When a BNWAS (Bridge Navigational Watch Alarm System) is connected, specify the time to transfer an unacknowledged alert to the BNWAS in a range between 0 and 30s.

Repetition of UNACK Warning:

Specify the time to regenerate an unacknowledged alert as an audible warning in a range between 0 and 300s. A warning will be generated repeatedly until it is acknowledged. The default value is 60 s.

Note

This is not applicable to the following warnings according to the Standard (operation that is defined in the IEC62065 (TCS) or IEC61174 (ECDIS) Standard). Warning are escalated to alarm, if warning was not acknowledged for the following times.

- Early Course Change Warning, Actual Course Change Warning, End Of Track Warning and Track Control Stopped Warning: 30 seconds (fixed)
- Outside Anchor Watch Area Warning: 120 seconds. (fixed)

Responsibility Transfer:

When click the check box, display of responsibility transferred alert is switched to ON or OFF.



Display of Responsibility transferred alert: ON



Display of Responsibility transferred alert: OFF



Section 16 Setting up the Operation Mode

16.1 Basic Operation of the [Settings] Dialog Box

You can set up the operation mode in the [Settings] dialog box.

- 1 Click on the [Menu] button on the left toolbar.

The menu is displayed.

- 2 Click on the [Settings] button.

The [Settings] dialog box appears.

The [Settings] dialog box consists of the classification pane and the Edit pane.

Click on the Disclosure button (>>) to hide the classification pane. To show the classification pane again, click on the Disclosure button (<<).

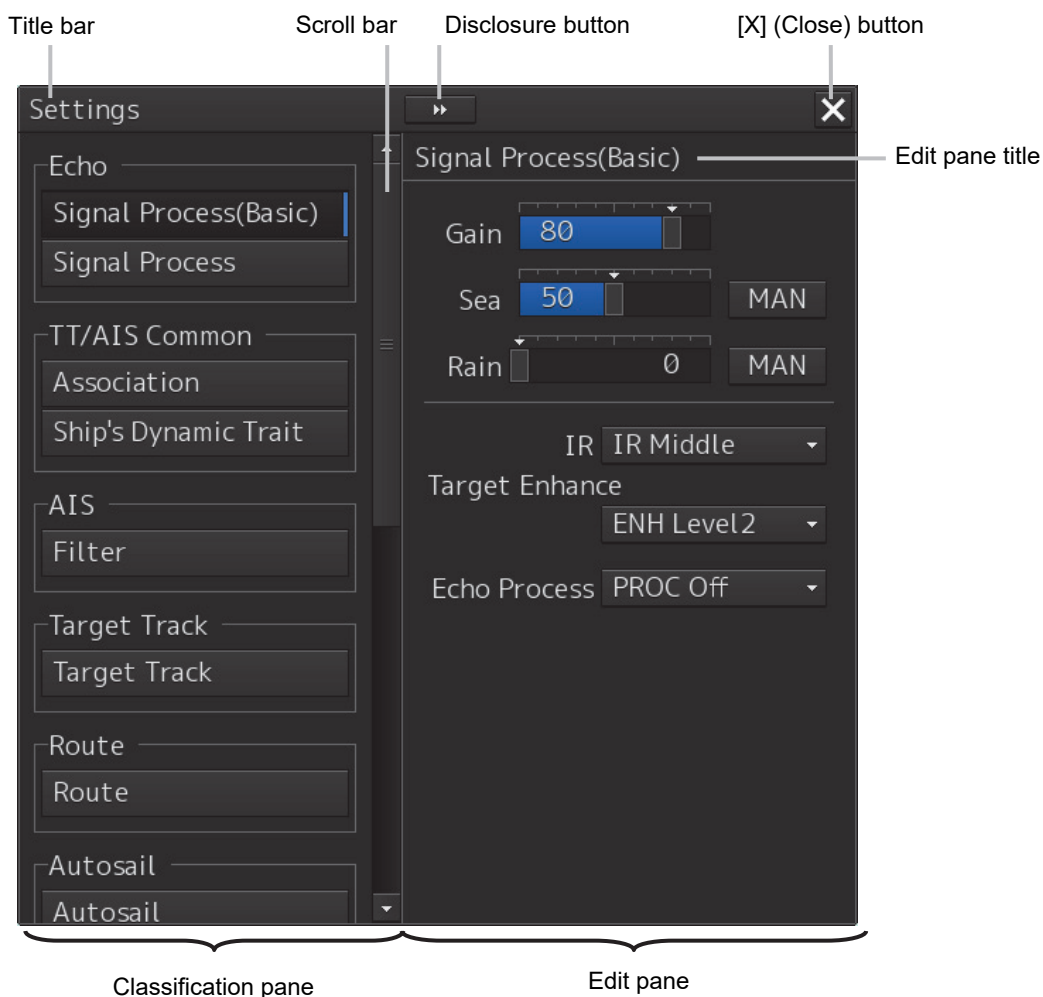

Display Example for the ECDIS

-
- 3** When all the classification panes are not displayed, drag the scroll bar upwards and downwards.

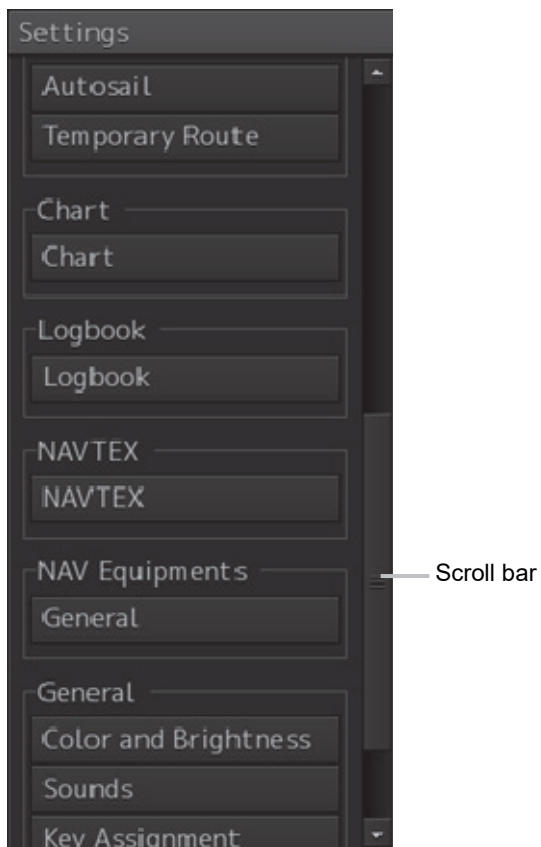

- 4** Click on the item you want to set up in the classification pane.
The setup dialog of the item you selected is displayed.
- 5** Set up in the Edit pane.

Classification pane display targets

The table below provides the descriptions of the classification panes that are displayed by ECDIS and the related sections.

| Classification pane | Related section |
|--------------------------------------|---|
| Signal Process(Basic) * ¹ | 16.2 Basic Settings for Radar Signal Processing |
| Signal Process * ¹ | 16.3 Settings of radar signal processing |
| Association | 16.4 Setting up Association |
| Ship's Dynamic Trait | 16.5 Setting up Own Ship's Dynamic Trait |
| Filter | 16.6 Setting up an AIS/TT Filter |
| Target Track | 16.7 Setting up Other Ship's Track Function to ON/OFF |
| Route | 16.8 Setting up Parameter Values at Route Planning Creation |
| Autosail * ² | 0 Setting up Parameter Values for Automatic Sailing |
| Temporary Route | 16.10 Setting up Parameter Values for Predicted Route |
| Chart | 16.11 Setting Chart Operation |
| Logbook | 16.12 Setting up Logbook |
| NAVTEX | 16.13 Setting NAVTEX |
| General | 16.14 Setting up Navigation Equipment |
| Color and Brightness | 16.15 Setting up Color and Brightness |
| Sounds | 16.16 Setting Sounds |
| Key Assignment | 16.17 Setting up Key Assignment |
| Preferences | 16.18 Setting Preferences Information |
| Screen capture | 16.19 Setting up Screen Capture |

*¹ In case of JAN-7201S/9201S, Radar option is not available by function restriction.

*² In case of JAN-7201S/9201S, automatic sailing option is not available by function restriction.

16.2 Basic Settings for Radar Signal Processing

Note

In case of JAN-7201S/9201S, overlay function is not available by function restriction. Therefore the setup is not available.

Select [Signal Process(Basic)] in the classification pane.

Set a basic processing method of radar signals in the setting dialog of the edit pane.



| Setting Item | Description of Setting | Setting Value |
|------------------------------|---|--|
| Gain | Rotate the dial to set the mode to the receiving sensitivity adjustment mode. | 0 to 100 |
| Sea (sea clutter adjustment) | Rotate the dial to set the mode to the sea clutter adjustment mode. By clicking on the dial in adjustment mode or clicking on the button next to the slider, the mode can be switched between manual (MAN) and automatic (AUTO). | 0 to 100 MAN: Manually removes sea clutters. AUTO: Automatically removes sea clutters. |

| Setting Item | Description of Setting | Setting Value |
|-------------------------------------|--|---|
| Rain (rain/snow clutter adjustment) | <p>Rotate the dial to set the mode to the rain/snow clutter adjustment mode.</p> <p>By clicking on the dial in adjustment mode or clicking on the button next to the slider, the mode can be switched between manual (MAN) and automatic (AUTO).</p> | <p>0 to 100</p> <p>MAN: Manually removes rain/snow clutters.</p> <p>AUTO: Automatically removes rain/snow clutters.</p> |
| IR | Set up the IR (Interference Removal) function. | <p>Off</p> <p>IR Low</p> <p>IR Middle</p> <p>IR High</p> |
| Target Enhance | Set up the Target Enhance function. | <p>ENH Off</p> <p>ENH Level1</p> <p>ENH Level2</p> <p>ENH Level3</p> |
| Echo Process | <p>Set up the Echo Process function.</p> <p>If the ship's heading cannot be acquired, [PROC Off] is set.</p> | <p>PROC Off</p> <p>3 Scan CORREL</p> <p>4 Scan CORREL</p> <p>5 Scan CORREL</p> <p>Remain</p> <p>Peak Hold</p> |

16.3 Settings of radar signal processing

Note

In case of JAN-7201S/9201S, overlay function is not available by function restriction. Therefore the setup is not available.

Select [Signal Process] in the classification pane.

Set various processing methods of radar signals in the setting dialog of the edit pane.

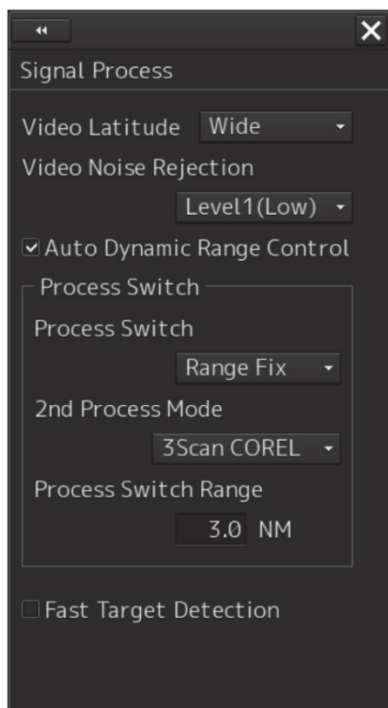

| Setting Item | Description of Setting | Setting Value |
|----------------------------|---|---|
| Video Latitude | Set up the gradation of the radar video. | Narrow Normal Wide Super Wide |
| Video Noise Rejection | Set up to remove noise and signals which are considered to be clutters of radar video. | Off Level1(Low) Level2(High) |
| Auto Dynamic Range Control | When this is selected, the dynamic range is automatically adjusted. | To enable: Select. To disable: Clear. |
| Process Switch | Specify a particular area and set up a mode for performing video processing on the inside and outside of the particular area. | Off Range Fix AUTO |
| 2nd Process Mode | Set up a processing mode used in the outside of the particular area. This is enabled when other than [Off] is being selected in the Process Switch combo box. | PROC Off 3Scan CORREL 4Scan CORREL 5Scan CORREL Remain Peak Hold |
| Process Switch Range | Set up the boundary range of a particular area. Enabled when [Range Fix] is selected in the Process Switch combo box. | 0.1 to 25.5 NM |
| Fast Target Detection | When this item is enabled, high-speed moving targets that are suppressed by the scan correlation processing can be detected more easily. | To enable: Select. To disable: Clear. |

16.4 Setting up Association

Select [Association] in the classification pane.

Set up TT/AIS in the setup dialog of the edit pane.

Make judgement on whether the AIS target and the tracked target are the same (identical target judgement); if they are deemed the same target, an association symbol is displayed on them. At this time, the symbol on the AIS target is automatically activated.

Note

If you don't want to perform an identical target judgement, or if you want to display hidden symbols, turn the association setting to Off.

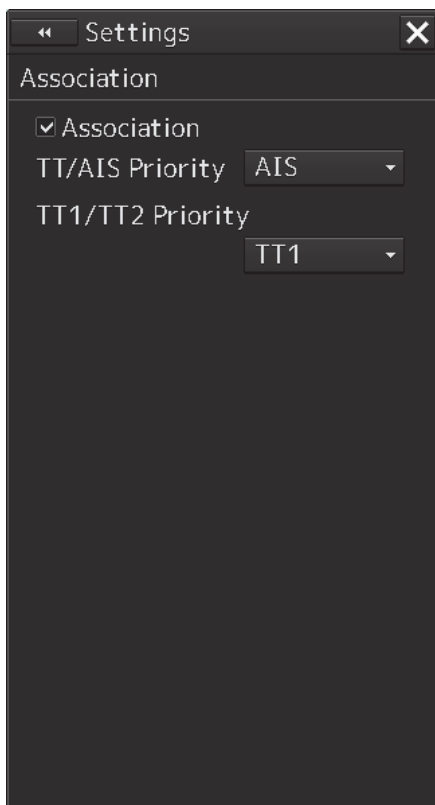

| Setting Item | Description of Setting | Setting Value |
|------------------|--|--|
| Association | Turn On/Off the association setting. | To enable: Select. To disable: Clear. |
| TT/AIS Priority | Select priority of association target display. | AIS TT |
| TT1/TT2 Priority | Select priority of association target display. | TT1 TT2 |

16.5 Setting up Own Ship's Dynamic Trait

Select [Ship's Dynamic Trait] in the classification pane.

Set up own ship's dynamic trait in the setting dialog of the edit pane.

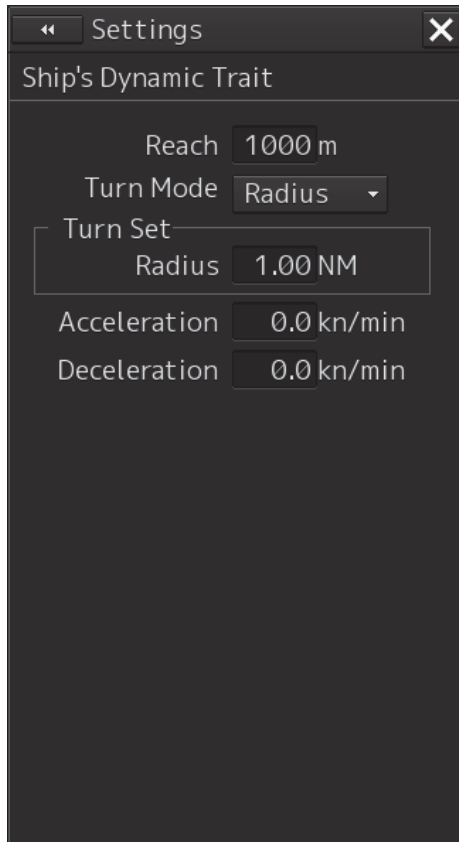

| Setting Item | Description of Setting | Setting Value |
|--------------|---|---------------------|
| Reach | Set up the distance to reach the turn. | 0 to 2000 m |
| Turn Mode | Set up the Turn mode. | Radius Rate |
| Radius | Enter the radius of the turn rate. This is displayed when [Radius] is selected in the [Turn Mode] box. | 0.10 to 2.00 NM |
| Rate | Enter the speed of the turn rate. This is displayed when [Rate] is selected in the [Turn Mode] box. | 20 to 720°/min |
| Acceleration | Enter the rate of change of speed (acceleration) of own ship's dynamic trait. | 0.0 to 100.0 kn/mir |
| Deceleration | Enter the rate of change of speed (deceleration) of own ship's dynamic trait. | 0.0 to 100.0 kn/mir |

16.6 Setting up an AIS/TT Filter

Select [Filter] in the classification pane.

Set up AIS/TT filter in the setting dialog of the edit pane.

When an AIS/TT filter is specified, AIS targets in that area can be displayed with highest priority or only targets in that area can be displayed.

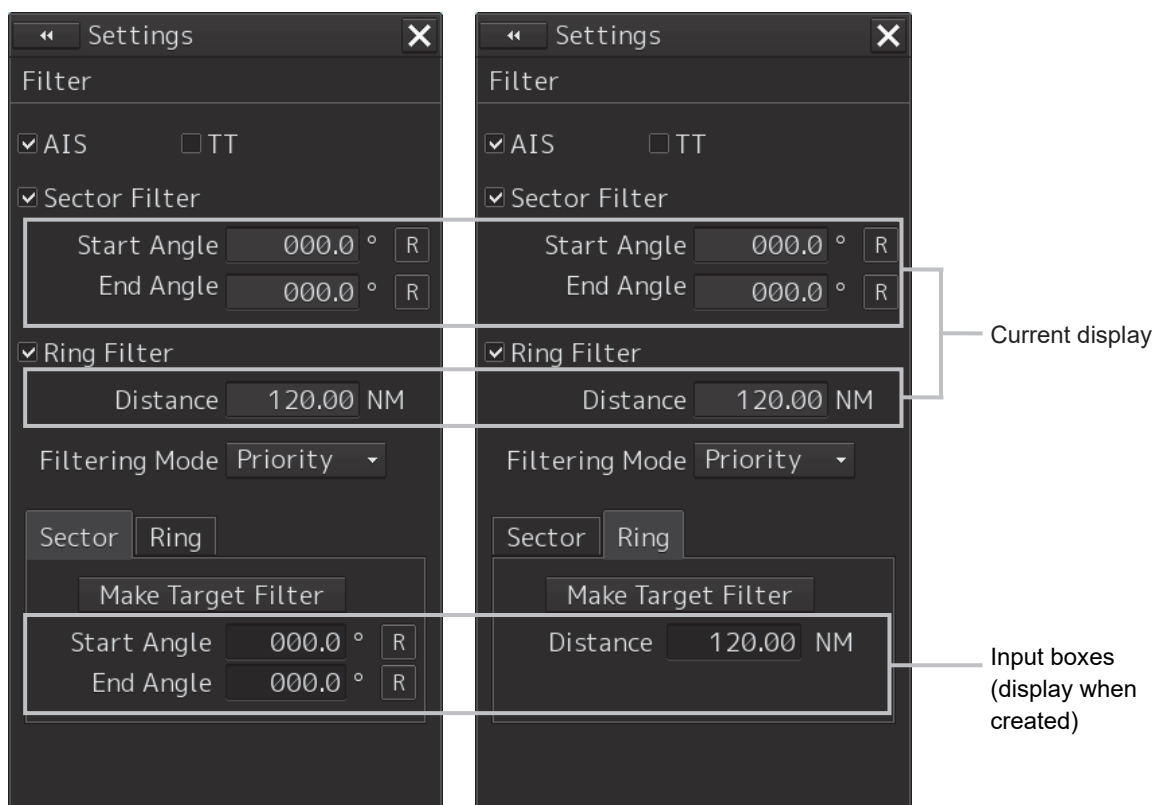

| Setting Item | Description of Setting | Setting Value |
|---------------|---|--|
| AIS | When this is selected, filtering AIS target is performed in the operation mode being selected in Filtering mode. | To enable: Select. To disable: Clear. |
| TT | When this is selected, filtering external target is performed in the operation mode being selected in Filtering mode. | To enable: Select. To disable: Clear. |
| Sector Filter | When this is selected, the Sector Filter is displayed on the screen and filtering is performed in the operation mode being selected in Filtering mode. | To enable: Select. To disable: Clear. |
| Start Angle | Set up the starting angle of the Sector Filter. The angle value indicates the relative bearing based on the ship's heading as the reference. When entry is confirmed, the entered value takes effect immediately. | 0.0 to 359.9° |
| End Angle | Set up the end angle of the Sector Filter. The angle value indicates the relative bearing based on the ship's heading as the reference. When entry is confirmed, the entered value takes effect immediately. | 0.0 to 359.9° |

| Setting Item | Description of Setting | Setting Value |
|----------------|---|--|
| Ring Filter | When this is selected, the Ring Filter is displayed on the dialog box and filtering is performed in the operation mode being selected in Filtering mode. | To enable: Select. To disable: Clear. |
| Distance | Set up the distance of the Ring Filter. When entry is confirmed, the entered value takes effect immediately. | 0.0 to 120.0 NM |
| Filtering Mode | Select an operation mode of the AIS/TT filter. Display: Targets cannot be displayed outside of the AIS/TT filter range. Priority: Priority is determined within the range of the AIS/TT filter and targets are displayed based on the priority. | Display Priority |

Creating a filter in the dialog

Creating a Sector Filter

- 1** Click on the [Sector] tab.
- 2** Click on [Make Target Filter].
The button is highlighted and the cursor mode is set to the Make Target Filter mode.
- 3** Move the cursor, place it on the starting angle of the Sector filter you want to set up, and then click on it.
- 4** Move the cursor, place it on the end angle of the Sector filter you want to set up, and then click on it.

Creating a Ring Filter

- 1** Click on the [Ring] tab.
- 2** Click on [Make Target Filter].
The button is highlighted and the cursor mode is set to the Make Target Filter mode.
- 3** Move the cursor, place it on the distance of the Ring filter you want to set up, and then click on it.

Note

When the AZ function is ON, a distance smaller than the outer arc of AZ cannot be set for the Ring filter.

Memo

<Priority setting>

- The sleeping Target in the AIS/TT filter has a higher priority than the sleeping Target outside of the AIS/TT filter (preferentially displayed).

<AIS/TT Filter OFF>

- The sleeping target in the AIS/TT filter has the same priority as the sleeping target outside of the filter.

16.7 Setting up Other Ship's Track Function to ON/OFF

Select [Target Track] in the classification pane.

Set up other ship's track function to ON/OFF in the setting dialog of the edit pane.

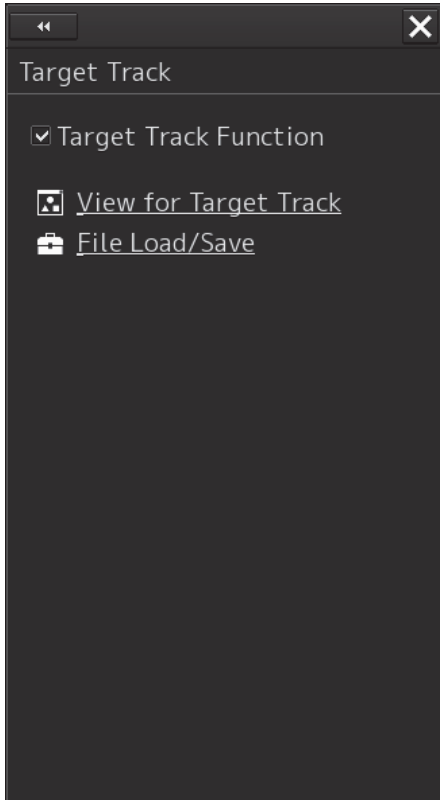

| Setting Item | Description of Setting | Setting Value |
|-----------------------|--|--|
| Target Track Function | Turn On/Off the target track function. | To enable: Select. To disable: Clear. |

Shortcuts

Click on any of the following shortcuts to display the related dialog box.

| Shortcut | Settings Dialog Box |
|-----------------------|---------------------------|
| View for Target Track | [Target Track] dialog box |
| File Load/Save | [File Manager] dialog box |

* Each target has a display setting, which defaults to OFF.
each target = OFF

16.8 Setting up Parameter Values at Route Planning Creation

Select [Route] in the classification pane.

Set up various settings at route planning creation in the setting dialog of the edit pane.

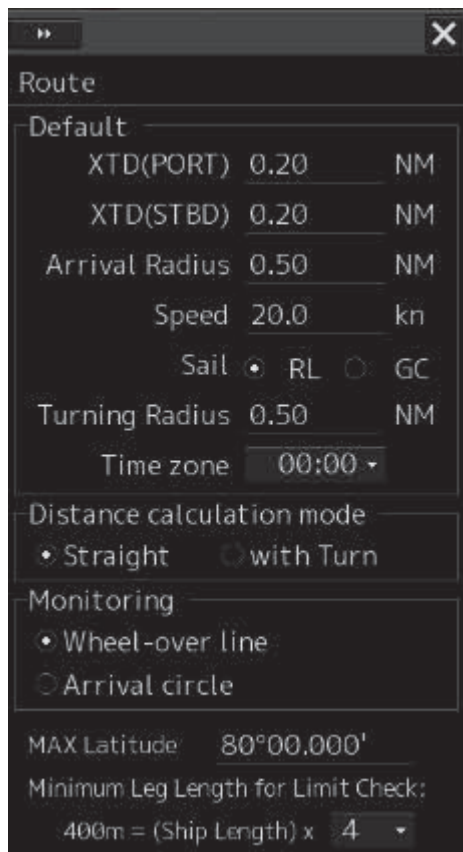

Set up the factory setting values for routes to be created during route planning.

| Setting Item | Description of Setting | Setting Value |
|----------------|---|------------------|
| XTD (PORT) | Set up the cross track limit of the port side. | 0.01 to 9.99 NM |
| XTD (STBD) | Set up the cross track limit of the starboard side. | 0.01 to 9.99 NM |
| Arrival radius | Set up the radius of the WPT (waypoint) arrival circle. | 0.01 to 9.99 NM |
| Speed | Set up the planned speed. | 1.0 to 99.9 kn |
| Sail | Set up sailing (RL (Rhumb Line) or GC (Great Circle)). | RL GC |
| Turning Radius | Set up the turn radius. | 0.10 to 9.99 NM |
| Time Zone | Set up the time zone. | -13:30 to +13:30 |

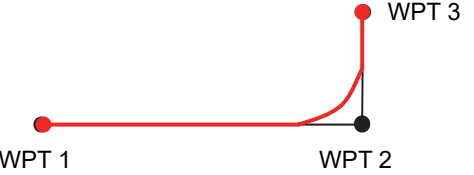
| Setting Item | Description of Setting | Setting Value |
|------------------------------------|--|---------------------------------|
| Distance Calculation Mode | <p>Set up the calculation method of the distance between WPTs.</p> <p>Straight: Calculates the distance between WPTs linearly (red line).</p>  <p>With Turn: Calculates the distance between WPTs using a predicted route (red line).</p>  | Straight with Turn |
| Monitoring | <p>Set up the route monitoring method.</p> <p>Wheel-over Line: monitored by using Wheel-over line (WOL) along each WPT.</p> <p>Arrival Circle: monitored by using the arrival circle along each WPT.</p> <p>The setting will be changed according to the type of auto pilot during automatic sailing.</p> | Wheel-over Line, Arrival Circle |
| MAX Latitude | <p>Because a WPT cannot be entered at a latitude higher than the latitude you set up when planning a route, this threshold is used to check the latitude of the destination during active route reception. If the threshold value is abnormal, an active route will not be loaded even if it is received.</p> <p>When creating a GC leg, if a leg is positioned over the latitude you set up, the composite sailing will take effect automatically and the leg will be divided into three segments. (GC-RL-GC)</p> | 30°00.000' to 80°00.000' |
| Minimum Leg Length for Limit Check | <p>Select a multiplier for determining the "Minimum Leg Length" which will be used for limit check.</p> <p>Minimum leg length = (Ship length) × Multiplier (τ multiplier)</p> | 1, 2, 4, 6, 8 |

16.9 Setting up Parameter Values for Automatic Sailing

Note

In case of JAN-7201S/9201S, automatic sailing function is not available by function restriction. Therefore the setup is not available.

Select [Autosail] in the classification pane.

Set up various settings of automatic sailing in the setting dialog of the edit pane.

Note

- Displayed when the automatic sailing option is attached.
- When PT900 is installed as auto pilot, [Autosail] is not displayed.

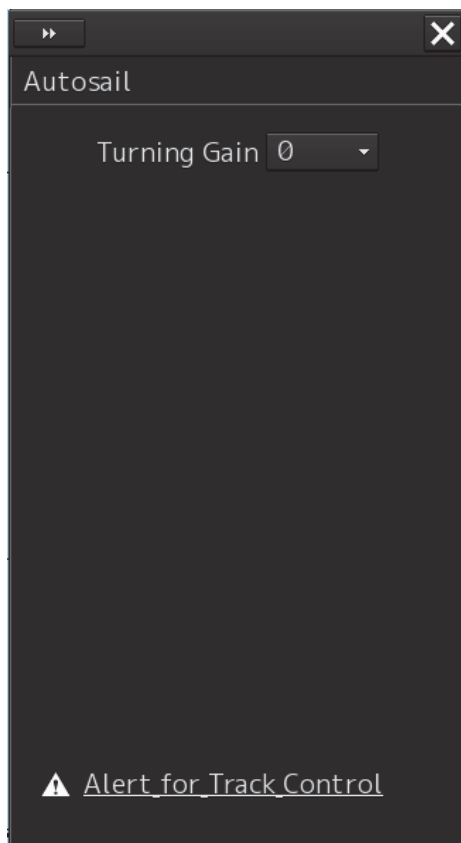

Example of screen display under the following conditions:

- Tokyo Keiki TCS Category C
- Tokyo Keiki TCS Category B (new system)

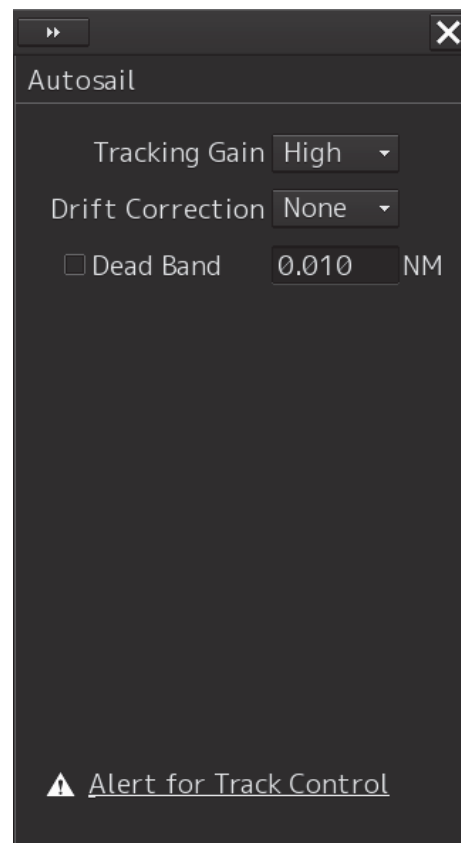

Example of screen display under the following conditions:

- Tokyo Keiki TCS Category B (old system)
- YDK TCS Category C

| Setting Item | Description of Setting | Setting Value |
|------------------|--|--|
| Tracking Gain | <p>Set up the tracking gain. This can be set up even during automatic sailing.</p> <p>The tracking gain value specifies how quickly the ship will return to the original course when it has deviated from the course.</p> <p>You can select from three tracking gain settings of [High], [Middle] and [Low].</p> <p>For example, assume that the target gain value is being set to "16 deg./NM" and the own ship is positioned at 1 NM right of the tracking gain.</p> <p>In this case, specify the distance for the own ship to approach the target at an angle of 16°.</p> <p>If the distance between the own ship and the target course is shortened, this angle will also be reduced.</p> <p>When the own ship has reached the target course, the angle will be the same as WP1 viewed from 0 of a WPT, and the more the LD will be, the larger this angle will get.</p> <p>Note that you may lose the control of the helm depending on the tracking gain value, so be careful with the setting.</p> | <p>Low</p> <p>Middle</p> <p>High</p> |
| Drift Correction | <p>Set up the drift correction. This can be set up even during automatic sailing.</p> <p>When this is set to On (High/Middle/Low), control is performed considering the tide if the own ship's speed is 5 knots or faster.</p> <div data-bbox="494 1164 805 1299" style="text-align: center;"> </div> <p>None: Off (Drift correction will not be performed.)</p> <p>High: Drift correction will be performed. The drift correction value is equivalent to the tidal vector (100%).</p> <p>Middle: Drift correction will be performed. The drift correction value is 2/3 of the tidal vector.</p> <p>Low: Drift correction will be performed. The drift correction value is 1/3 of the tidal vector.</p> | <p>None</p> <p>High</p> <p>Middle</p> <p>Low</p> |

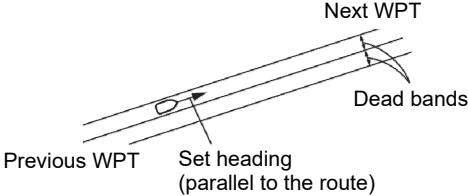
| Setting Item | Description of Setting | Setting Value |
|---|---|---|
| Dead Band (On/Off) | <p>Set up On/Off of the dead band. This can be set up even during automatic sailing.</p> <p>To prevent yawing while navigation, it is necessary to provide dead bands at both sides of the current course.</p> <p>If the own ship is positioned within the dead band course, the course will be fixed at [Track Course]. For more details, see the following drawing.</p>  <p>The diagram illustrates a ship's heading (parallel to the route) between two waypoints (Previous WPT and Next WPT). The heading is shown as a line with an arrow pointing towards the Next WPT. The dead bands are shown as two lines on either side of the heading, forming a narrow corridor. The ship is positioned within this corridor.</p> | <p>To enable: Select.</p> <p>To disable: Clear.</p> |
| Dead Band (setting value) | Specify the dead band value. This can be set up even during automatic sailing. | 0.001 to 0.999 NM |
| Turning Gain | Set up the turning gain. This can be set up even during automatic sailing. | 0 to 4 |
| Display when the TCS is | <p>The turning gain represents how much the turning radius will be changed according to the XTD when changing the course.</p> <p>You can select the turning gain in a range from 0 to 4.</p> <ul style="list-style-type: none"> • 0: Changes the course using the planned radius without depending on the XTD during course change. • 1 to 4: Changes the turning radius according to the XTD during course change. (1 is the weakest gain and 4 is the strongest gain.) | |
| • Tokyo Keiki TCS Category C | | |
| • Tokyo Keiki TCS Category B (new system) | | |

Shortcut

Click on the following shortcut to display the related dialog box.

| Shortcut | Settings Dialog Box |
|-------------------------|----------------------------|
| Alert for Track Control | [Track Control] dialog box |

16.10 Setting up Parameter Values for Predicted Route

Select [Temporary Route] in the classification pane.

Set up various settings of predicted route in the setting dialog of the edit pane.

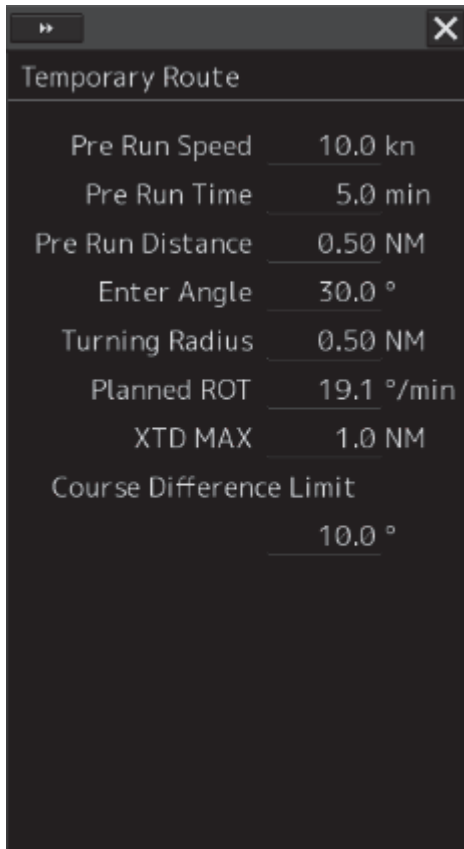

Before starting automatic sailing, move own ship along the leg.

| Setting Item | Description of Setting | Setting Value |
|-------------------------|---|---|
| Pre Run Speed | Set a planned ship speed of the temporary route to calculate the minimum leg length. | 0.0 to 99.9 kn |
| Pre Run Time | Set a planned time of the temporary route to calculate the minimum leg length. | 1.0 to 30.0 min |
| Pre Run Distance | Set a planned distance of the temporary route. | 0.10 to 9.99 NM |
| Enter Angle | Set an entrance angle of the temporary route. | 30.0 to 90.0° |
| Turning Radius | Set an initial turn radius of the temporary route. | 0.10 to 9.99 NM |
| Planned ROT | Set the predicted value of ROT(Rate of Turn). Calculated from Pre Run Speed and Turning Radius, when entering the value of Planned ROT, the value of Turning Radius is calculated and fluctuates. | It will be changed by the value of Pre Run Speed. |
| XTD MAX | Set the maximum XTD of the temporary route. | 0.0 to 1.0 NM |
| Course Difference Limit | Set the difference of the leg bearing of the predicted course and ship's heading. | 0.5 ~ 45.0° |

Memo

The minimum leg length is expressed in the following formula.

Minimum leg length = (planned ship speed of the temporary route × planned time of the temporary route) + planned distance of the temporary route + reach

16.11 Setting Chart Operation

Select [Chart] in the classification pane.

Set chart operation in the setting dialog of the edit pane.

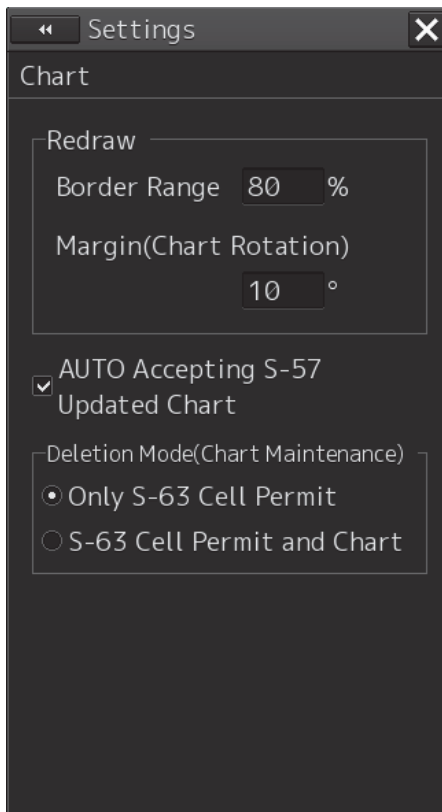

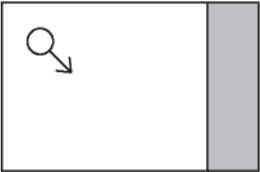
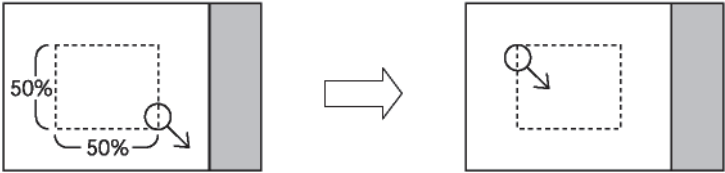
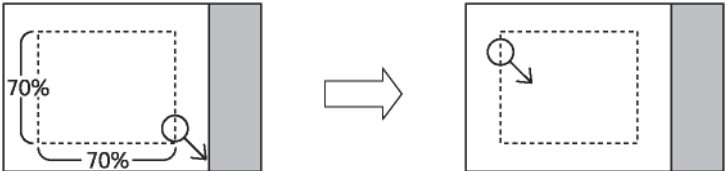
| Setting Item | Description of Setting | Setting Value |
|-----------------------------------|---|--|
| Border Range | <p>Set up the range for the own ship in order to move the chart. This is displayed only on the ECDIS screen.</p> <ul style="list-style-type: none"> When the own ship is sailing in the direction of the arrow in the figure below.  <ul style="list-style-type: none"> If the border range you set up is 50%, the screen display switches when the own ship reaches a 50% area from an edge of the screen.  <ul style="list-style-type: none"> If the border range you set up is 70%, the screen display switches when own ship reaches the border range.  | 30 to 80 % |
| Margin (Chart Rotation) | When head-up, if own ship turns at the angle specified here, the chart will also turn. For example, if the margin is set to 10°, the chart will turn when own ship turns 10° or more. | 0 to 90° |
| AUTO Accepting S-57 Updated Chart | Set whether the chart is accepted automatically at completion of chart import. | Accepted automatically: Check Not accepted automatically: Not check |
| Deletion Mode(Chart Maintenance) | Set the operation mode of the Delete button on the status screen in Chart Maintenance. Only S-63 Cell Permit: When the Delete button is pressed, only the license is deleted. S-63 Cell Permit and Chart: When the Delete button is pressed, the licence or chart is deleted. | Only S-63 Cell Permit S-63 Cell Permit and Chart |

Memo

The setting of Deletion Mode(Chart Maintenance) is valid only under S-63 (ENC that requires Permit). Under S-57 (ENC that does not require Permit), the chart is also deleted regardless of this setting.

16.12 Setting up Logbook

Select [Logbook] in the classification pane.

Set up various settings of logbook in the setting dialog of the edit pane.

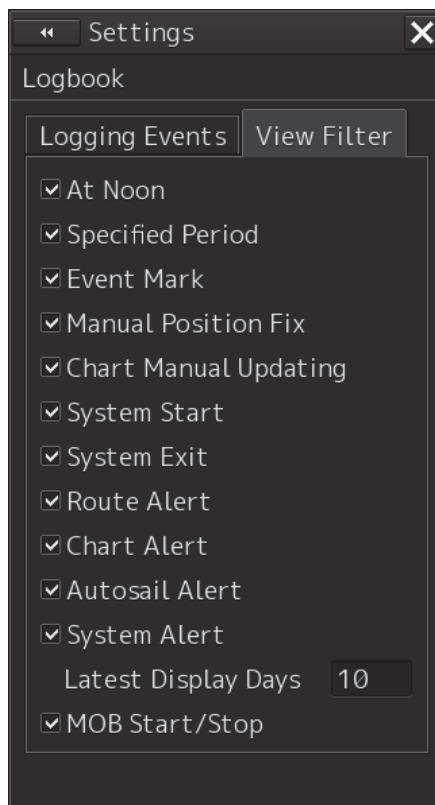
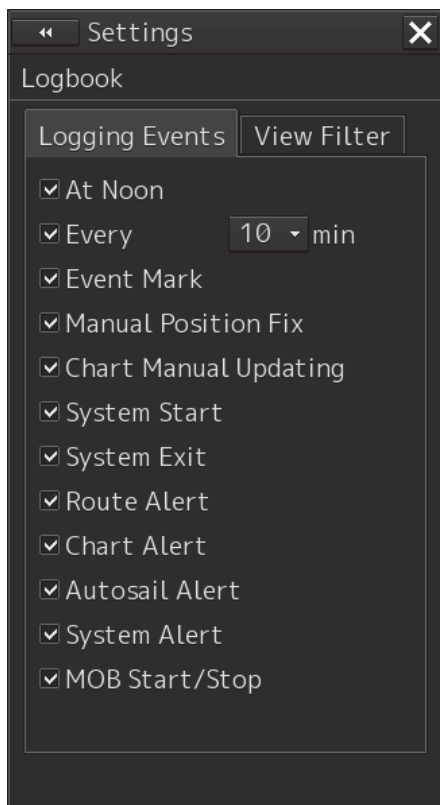

[Logging Events] tab

| Setting Item | Description of Setting | Setting Value |
|------------------------------|---|---|
| At Noon | When this is selected, log data is saved at 12:00 (LMT). | To enable: Select. To disable: Clear. |
| Every ([Logging Events] tab) | When this is selected, log data is saved at the interval specified in the combo box. | <Check box> To enable: Select. To disable: Clear. <Selections in the combo box> 1/3/5/10/15/30/60 min |
| Event Mark | When this is selected, log data is saved when the EVENT button is pressed. | To enable: Select. To disable: Clear. |
| Manual Position Fix | When this is selected, the time, bearing, position, objects used during manual position fixing in cross bearing or running fix are saved. | To enable: Select. To disable: Clear. |

| Setting Item | Description of Setting | Setting Value |
|-----------------------|--|--|
| Chart Manual Updating | When this is selected, log data is saved when the chart is manually updated. | To enable: Select. To disable: Clear. |
| Reference Point | When this is selected, log data is saved when a reference point is set up. | To enable: Select. To disable: Clear. |
| System Start | When this is selected, log data is saved when the system is started. | To enable: Select. To disable: Clear. |
| System Exit | When this is selected, log data is saved when the system is shut down. | To enable: Select. To disable: Clear. |
| Route Alert | When this is selected, log data is saved when a route-related alert is generated. | To enable: Select. To disable: Clear. |
| Chart Alert | When this is selected, log data is saved when a chart-related alert is generated. | To enable: Select. To disable: Clear. |
| AUTO Sail Alert | When this is selected, log data is saved when an auto sail-related alert is generated. | To enable: Select. To disable: Clear. |
| System Alert | When this is selected, log data is saved when a system-related alert is generated. | To enable: Select. To disable: Clear. |
| MOB Start/Stop | When this item is enabled, MOB start and MOB stop are recorded. | Enable: Check. Disable: Uncheck. |

[View Filter] tab

| Setting Item | Description of Setting | Setting Value |
|-----------------------|--|--|
| At noon | When this is selected, the events saved at 12:00 (LMT) are displayed in the list. | To enable: Select. To disable: Clear. |
| Specified Period | When this is selected, the events saved at the interval specified in [Logging] are displayed in the list. | To enable: Select. To disable: Clear. |
| Event Mark | When this is selected, the events saved when the EVENT button was pressed are displayed in the list. | To enable: Select. To disable: Clear. |
| Manual Position Fix | When this is selected, the events saved during manual position fixing in cross bearing or running fix are displayed in the list. | To enable: Select. To disable: Clear. |
| Chart Manual Updating | When this is selected, the events saved when the chart was manually updated are displayed in the list. | To enable: Select. To disable: Clear. |
| System Start | When this is selected, the events saved when the system was started are displayed in the list. | To enable: Select. To disable: Clear. |

| Setting Item | Description of Setting | Setting Value |
|---------------------|--|--|
| System Exit | When this is selected, the events saved when the system was shut down are displayed in the list. | To enable: Select. To disable: Clear. |
| Route Alert | When this is selected, the events saved when a route-related alert was generated are displayed in the list. | To enable: Select. To disable: Clear. |
| Chart Alert | When this is selected, the events saved when a chart-related alert was generated are displayed in the list. | To enable: Select. To disable: Clear. |
| AUTO Sail Alert | When this is selected, the events saved when an auto sail-related alert was generated are displayed in the list. | To enable: Select. To disable: Clear. |
| System Alert | When this is selected, the events saved when a system-related alert was generated are displayed in the list. | To enable: Select. To disable: Clear. |
| Latest Display Days | The days on which the items saved in the Other event were specified are displayed in a range between 1 and 90. | 1 to 90 |
| MOB Start/Stop | When this item is enabled, MOB start and MOB stop are displayed. | Enable: Check. Disable: Uncheck. |

16.13 Setting NAVTEX

Select [NAVTEX] in the classification pane.

Set the display method for the NATVEX message that is displayed by clicking on the [NAVTEX] button on the information reference window in the editing pane setting dialog.

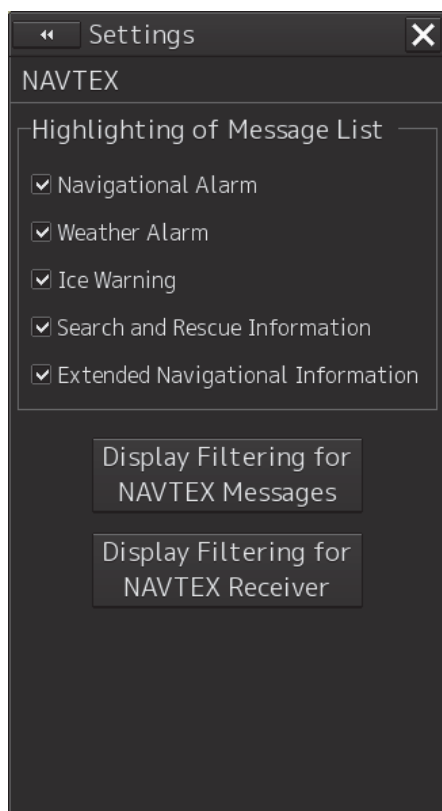

| Setting item | Setting contents | Setting value |
|-------------------------------|---|-----------------------------------|
| Navigational Alarm | Set highlighted display of the navigation alarm. When the item is enabled, the message is displayed with black characters on the yellow background. | Enable: Check Disable: Uncheck |
| Weather Alarm | Set highlighted display of the weather alarm. When the item is enabled, the message is displayed with black characters on the yellow background. | Enable: Check Disable: Uncheck |
| Ice Warning | Set highlighted display of the Ice Warning. When the item is enabled, the message is displayed with black characters on the yellow background. | Enable: Check Disable: Uncheck |
| Search and Rescue Information | Set highlighted display of the search and rescue information. When the item is enabled, the message is displayed with black characters on the yellow background. | Enable: Check Disable: Uncheck |

| Setting item | Setting contents | Setting value |
|--|---|-----------------------------------|
| Extended Navigational Information | Set highlighted display of the navigation alarm supplementary information. When the item is enabled, the message is displayed with black characters on the yellow background. | Enable: Check Disable: Uncheck |
| [Display Filtering for NAVTEX Messages] button | When this button is clicked on, the [Display Filtering for NAVTEX Messages] dialog is opened. For details, refer to “Displaying only the NAVTEX messages that satisfy a specific condition”. | - |
| Display Filtering for NAVTEX Receiver] button | When this button is clicked on, the [Display Filtering for NAVTEX Receiver] dialog is opened. For details, refer to “Receiving only the NAVTEX messages that satisfy a specific condition”. | |

Displaying only the NAVTEX messages that satisfy a specific condition

When the [Display Filtering for NAVTEX Messages] button is clicked on, the [Display Filtering for NAVTEX Messages] dialog is displayed.

In this dialog, NAVTEX messages to be displayed can be filtered.

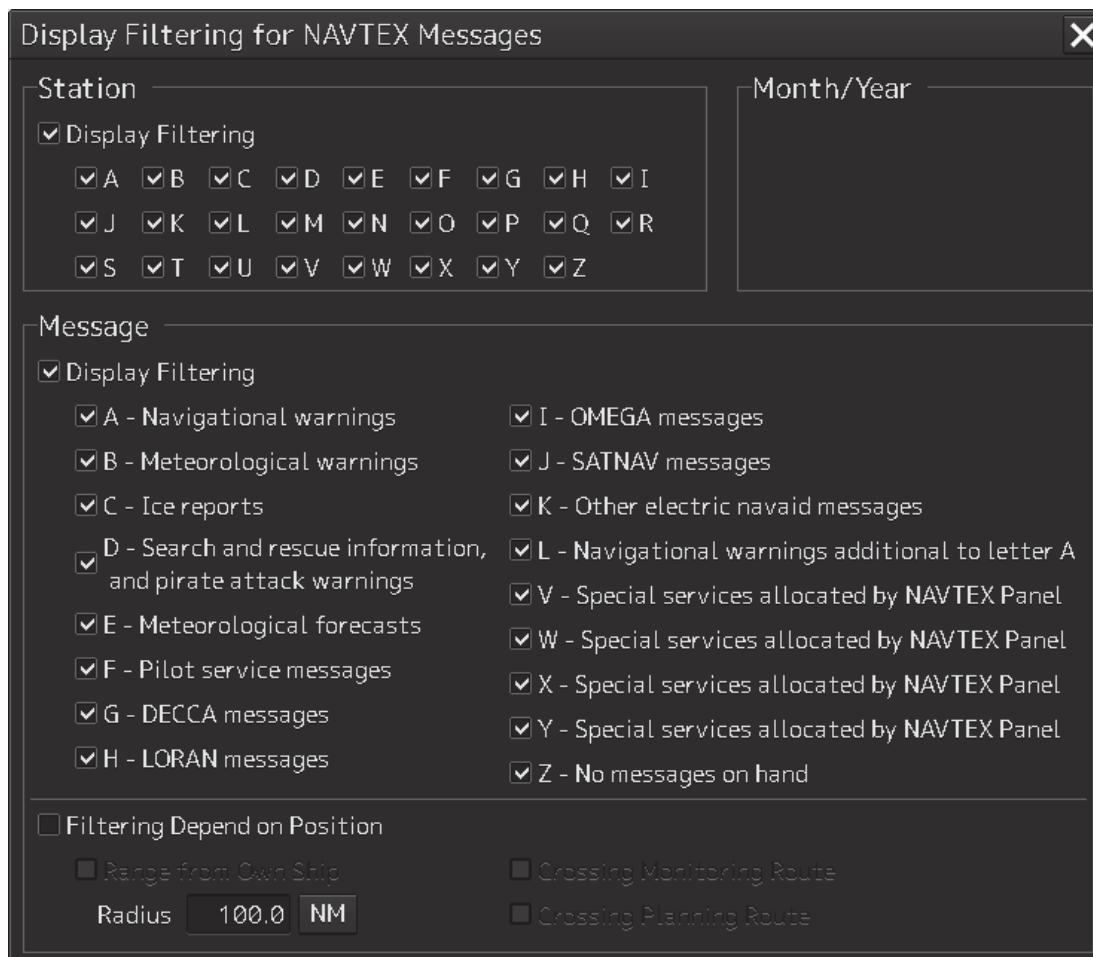

| Setting item | Setting contents | Setting value |
|--|--|-----------------------------------|
| Station – Display Filtering | Select a base station from which messages are to be displayed. By checking the Display Filtering check box, the check box of each base station can be checked. Select a required base station by checking the check box. | Enable: Check Disable: Uncheck |
| Month/Year | Only the messages that are received on the selected month/year are displayed. Select a required month/year by checking the check box. | Enable: Check Disable: Uncheck |
| Message – Display Filtering | Select a type of the messages to be displayed. By checking the Display Filtering check box, the check boxes of message types can be checked. Select a required message type by checking the check box. | Enable: Check Disable: Uncheck |
| Message – Filtering Depend on Position | Whether to perform display filtering by position is selected. By checking the Filtering Depend on Position check box, you can select detailed filtering conditions. | Enable: Check Disable: Uncheck |
| Message – Filtering Depend on Position – Range from Own Ship | Choose whether to perform display filtering by the distance from the ship's position. When checked, filtering is performed by the distance from the ship's position to the set value of the Radius input box. | Enable: Check Disable: Uncheck |
| Message – Filtering Depend on Position – Radius | Enter the distance of the filter from your ship. Click the NM / min button to switch the unit. | 0.1~300 NM 1.0~30.0 min |
| Message – Filtering Depend on Position – Crossing Monitoring Route | Choose whether to perform display filtering by route selected during route monitoring. When checked, filtering is carried out by the route monitoring range. | Enable: Check Disable: Uncheck |
| Message – Filtering Depend on Position – Crossing Planning Route | Choose whether to perform display filtering by route selected during route planning. When checked, filtering is carried out by the route planning range. | Enable: Check Disable: Uncheck |

Receiving only the NAVTEX messages that satisfy a specific condition

Click the Display Filtering for NAVTEX Receiver button to open the "Display Filtering for NAVTEX Receiver" (NAVTEX Message Receive Filtering) dialog.

In this dialog, you can filter (narrow down) the displayed NAVTEX message.

- 1 Click the Display Filtering for NAVTEX Receiver button.
A dialog box labeled "Waiting for a response from the NAVTEX receiver" is displayed.

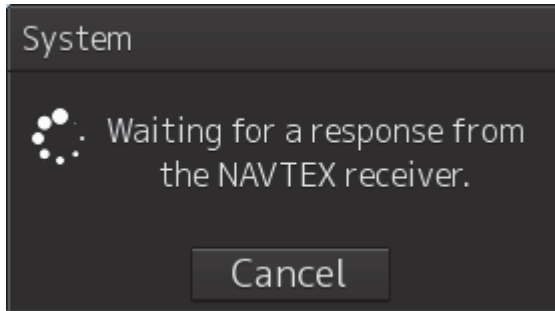

- 2 When the NAVTEX receiver is connected, open the "Display Filtering for NAVTEX Receiver" dialog (NAVTEX Message Receive Filtering) dialog.

If there is no response from the NAVTEX receiver, a popup with "No response from NAVTEX receiver" is displayed. When this popup is displayed, check the connection with the NAVTEX receiver.

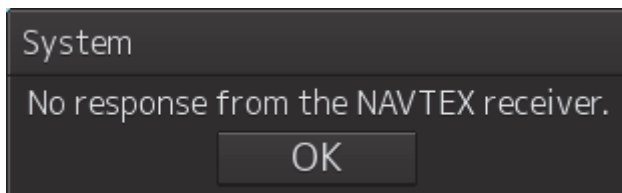

| Setting item | Setting contents | Setting value |
|-----------------------------|---|---|
| FREQUENCY | Displaying NAVTEX frequency. | RX(518 KHz) |
| Setting Type | Select the setting type of the NAVTEX receiver. | RX Station / Message Type Setting Printer Message Output Setting INS Message Output Setting |
| Station – Display Filtering | Choose from which base station to receive and output messages. If you check the Display Filtering check box, you can check the check box of each base station. Next, check the check box of the desired base station and select it. | Enable: Check Disable: Uncheck |

| Setting item | Setting contents | Setting value |
|-----------------------------|---|-----------------------------------|
| Month/Year | Only messages received at the selected year / month are displayed. Check the check box of the desired year and month and select it. | Enable: Check Disable: Uncheck |
| Message – Display Filtering | Choose which type of message you want to display. If you check the Display Filtering checkbox, you can check the checkbox of message type. Next, select the check box of the kind of the desired message and select it. | Enable: Check Disable: Uncheck |

16.14 Setting up Navigation Equipment

Select [General] in the classification pane.

Set up various settings of navigation equipment in the setting dialog of the edit pane.

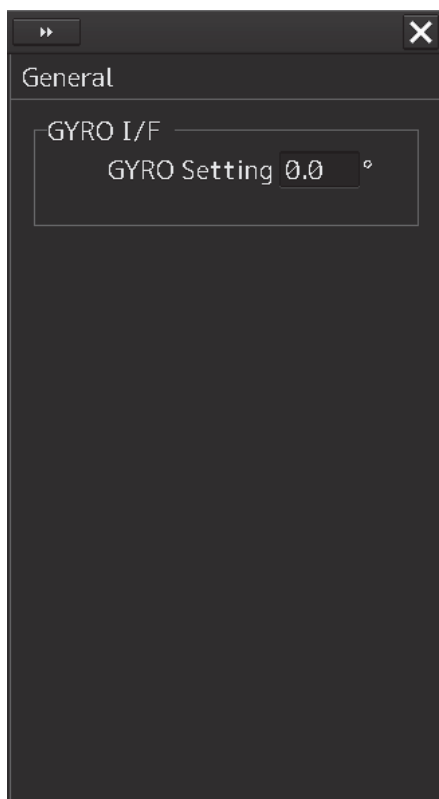

| Setting Item | Description of Setting | Setting Value |
|--------------|--------------------------------------|---------------|
| GYRO Setting | Enter the initial value of the gyro. | 0.0 to 359.9° |

16.15 Setting up Color and Brightness

Select [Color and Brightness] in the classification pane.

Set the color and the brightness of the display contents in the setting dialog of the edit pane.



[1] [Def.] (default value) button

When this button is clicked on, all the setting items of the mode that is selected on the [Day/Night] combo box are reset to the default values.

| Setting Item | Description of Setting | Setting Value |
|----------------------------|---|---|
| Day/Night | Set up the color of the dialog box itself. Select the chart display colors from the three types of Day1, Day3 and Night when the ARCS is used. | Day1 [default] Day2 Day3 Dusk Night |
| [Display Color] tab | | |
| Dialog | Set up the color of the dialog. | Dark [default] Black |
| Character | Set up the text color. | White [default] Green |

| Setting Item | Description of Setting | Setting Value |
|----------------------------|--|---|
| [Display Color] tab | | |
| RADAR Video | Set up the color of radar video. Displays the color of radar video only if it has a RADAR display function. | Yellow [default] Green Orange Purple Dark Red |
| Target Symbol | Set up the color of the target symbol. | White/Black* ¹ Cyan Green [default] Orange |
| Range Rings | Set up the color of range rings. | White/Black* ¹ Cyan [default] Green Orange |
| EBL1/VRM1/PI | Set up the color of EBL1, VRM1 and parallel index lines. | White/Gray* ¹ Cyan Green Orange [default] |
| EBL2/VRM2 | Set up the color of EBL2 and VRM2. | White/Gray* ¹ [default] Cyan Green Orange |
| Own Symbol/HL/Vector | Set up the color of own ship symbol, heading line and vector. | White/Black* ¹ [default] Cyan Green Orange |
| ALL GPS Buoy | Set up the color of all GPS Buoy symbols. Set up the same color for all GPS buoy symbols. | White/Black* ¹ [default] Gray /Amber /Magenta /Blue /Cyan /Green /Yellow /Orange /Dark Red |
| Individual | Select a color for each GPS buoy. Set up the GPS Buoy 1 to 10, Other respectively. | White/Black/Gray /Amber /Magenta /Blue /Cyan /Green /Yellow /Orange /Dark Red |
| [Brightness] tab | | |
| Character | Set up the text brilliance. | Level1(Dark) [default of Day 3] Level2 [default of Day 2, Dusk] Level3 [default of Day 1] Level4(Light) [default of Night] |
| RADAR Video | Set up the brilliance of radar video. | Level1(Dark) Level2 Level3 Level4(Light) [default] |

| Setting Item | Description of Setting | Setting Value |
|-------------------------|--|--|
| [Brightness] tab | | |
| Target Symbol | Set up the brilliance of the target symbol. | Level0(Dark) Level1 Level2 Level3 [default of DAY3/Dusk/Night] Level4(Light) [default of Day1/2] |
| Range Rings | Set up the brilliance of range rings. | Level1(Dark) Level2 [default of Night] Level3 [default of DAY3/Dusk] Level4(Light) [default of Day1/2] |
| EBL/VRM/PI | Set up the brilliance of EBL, VRM and parallel index lines. | Level1(Dark) Level2 Level3 [default of DAY3/Dusk/Night] Level4(Light) [default of Day1/2] |
| Own Symbol/HL/Vector | Set up the brilliance of own ship symbol, heading line and vector. | Level1(Dark) Level2 Level3 [default of DAY3/Dusk/Night] Level4(Light) [default of Day1/2] |
| Panel | Set the brightness of the operation unit. | Off Level1(Dark) [Default value of Dusk/Night] Level2 [Default value of Day3] Level3 [Default value of Day2] Level4(Light) [Default value of Day1] |
| Display | Set the value that is input in the box for the brightness of the display unit. | 0 to 100 ² |

*1: Under either of the following conditions, Black or Gray can be selected instead of White.

- ENC is displayed while [Day/Night] is set to Day1 or Day2.
- ARCS is displayed while [Day/Night] is set to Day.

*2: The brightness default values are as follows

| 26inch screen(NWZ-208) | 19inch screen(NWZ-207) | 19inch screen(NWZ-214) |
|------------------------|------------------------|------------------------|
| Day1/Day2/Day3: 67 | Day1/Day2/Day3: 42 | Day1/Day2/Day3: 70 |
| Dusk: 60 | Dusk: 20 | Dusk: 62 |
| Night: 11 | Night: 4 | Night: 10 |

(2) Next botton

It is displayed when the GPS buoy is available.

When you click the second page is displayed, you can set the color of the GPS buoy.

If it is disabled, it will be hidden.

16.16 Setting Sounds

Select [Sounds] in the classification pane.

Set up the volumes of the operation sounds and error sounds and alarm melody in the setting dialog of the edit pane.

When the volume or melody is to be changed, the volume can be set while listening to the sound since the selected volume or melody is played back.

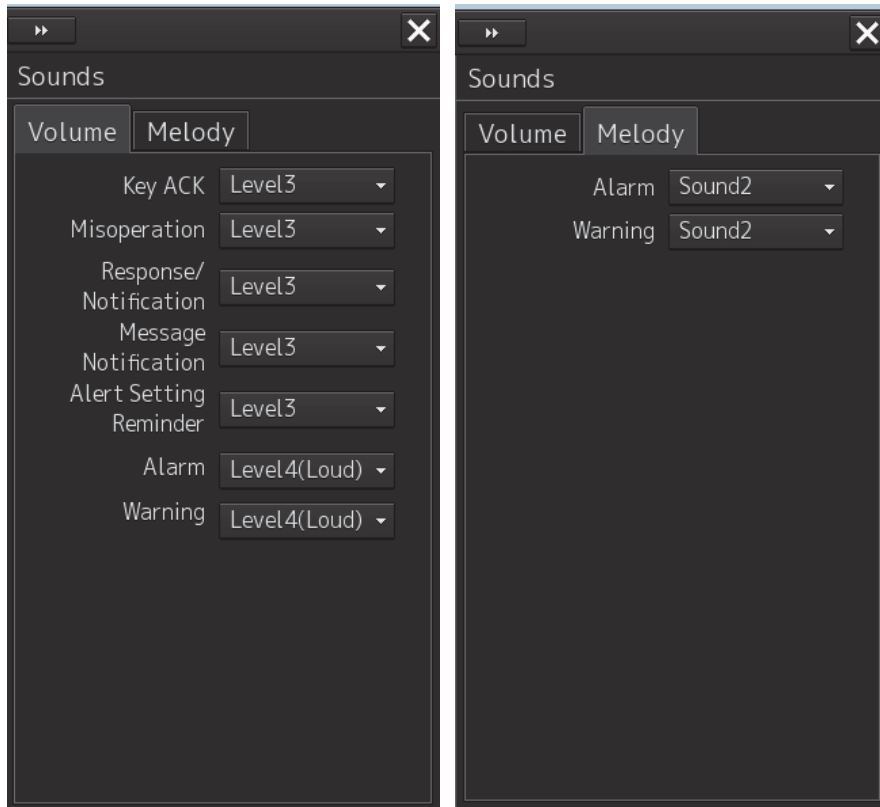

| Setting item | Setting contents | Setting value |
|------------------------|---|---|
| [Volume] tab | | |
| Key ACK | Set the volume of the sound emitted when the key is pressed. | Off Level1(Soft) Level2 Level3 [Default] Level4(Loud) |
| Misoperation | Set the volume of the operation error sound. | Off Level1(Soft) Level2 Level3 [Default] Level4(Loud) |
| Response/Notification | Set the volume of the control response sound to external equipment and control completion notification sound (including the interswitch control) from external equipment. | Off Level1(Soft) Level2 Level3 [Default] Level4(Loud) |
| Message Notification | Set the volume of the message notification sound. | Off Level1(Soft) Level2 Level3 [Default] Level4(Loud) |
| Alert Setting Reminder | Set the volume of the sound notifying that the alarm condition has not been set. | Off Level1(Soft) Level2 Level3 [Default] Level4(Loud) |
| Alarm | Set the volume of the alarm sound.*1 | Level4(Loud) |
| Warning | Set the volume of the system alarm sound.*1 | Level4(Loud) |
| [Melody] tab | | |
| Alarm | Set the melody of the alarm. | Sound1 Sound2[Default] Sound3 Sound4 |
| Warning | Set up the melody of Warning. | Sound1 Sound2[Default] Sound3 Sound4 |

*1 For these volumes, only Level 4 (Loud) is able to be selected.

16.17 Setting up Key Assignment

Select [Key Assignment] in the classification pane.

Set the keys in the operation unit and the function assigned to the [MULTI] dial in the setting dialog of the edit pane.

Only those items of the functions that can be specified in the task dialog are displayed.

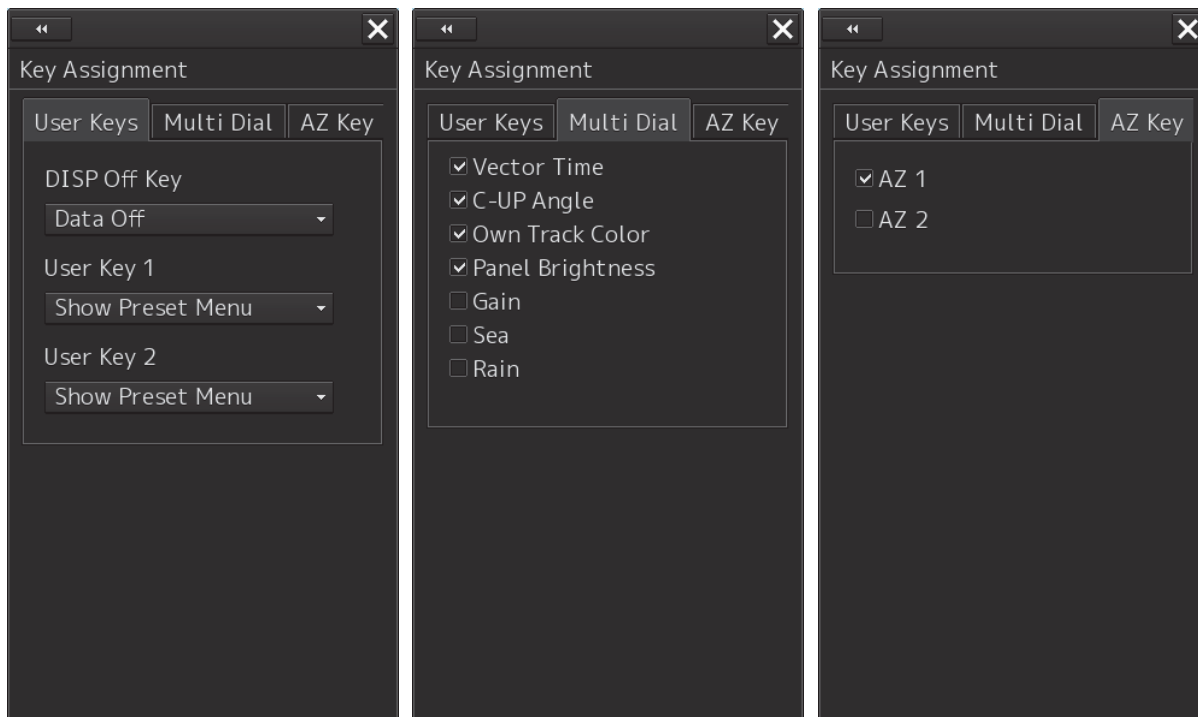

The [User Keys] and [AZ Key] tabs are displayed only when the optional operation unit is installed.

| Setting Item | Description of Setting | Setting Value |
|------------------------|--|------------------------------------|
| [User Keys] tab | | |
| DISP Off Key | Select a function to assign to the DISP Off key on the operation unit. [DISP Off Key] is displayed only when the optional operation unit is installed. It will be not displayed on the CAM screen. | - |
| User Key 1 | Select a function to assign to the USER1 key on the operation unit. [User Key 1] is displayed only when the optional operation unit is installed. | Show Preset Menu Capture Screen |
| User Key 2 | Select a function to assign to the USER2 key on the operation unit. [User Key 2] is displayed only when the optional operation unit is installed. | Show Preset Menu Capture Screen |

Below is a list of functions that can be assigned to User Keys.

| Function name | Function description |
|---------------------|--|
| Show Preset Menu | The screen registered separately is displayed. |
| Capture Screen | Get screen capture. |
| Change Active Panel | Displays the boundary of the chart. It can be set only when ARCS is used. |
| Load Low Resolution | Change to low resolution. It can be set only when ARCS is used. |

Below is a list of screens that can be assigned to Show Preset Menu.

| Screen name |
|---------------------|
| Route Planning |
| Route Monitoring |
| Anchor Watch |
| Manual Position Fix |
| Cursor Readout |
| View - Option |
| Alert |
| Settings |
| Blocking Area List |

| Setting Item | Description of Setting | Setting Value |
|-------------------------|---|--|
| [Multi Dial] tab | | |
| Vector Time | When this is selected, the vector length setup function will be manipulated with the [MULTI] control. | To enable: Select. To disable: Clear. |
| C UP Angle | When this is selected, the course adjustment function in the course-up mode will be manipulated with the [MULTI] control. | To enable: Select. To disable: Clear. |
| Own Track Color | When this is selected, the own ship track color switch function will be manipulated with the [MULTI] control. | To enable: Select. To disable: Clear. |
| Display Brightness | When this is selected, the display brightness adjustment function will be manipulated with the [MULTI] control. It cannot be changed since power is always on. | Always enabled. |
| Panel Brightness | When this is selected, the operation unit brightness adjustment function will be manipulated with the [MULTI] control. This item is always displayed. | To enable: Select. To disable: Clear. |
| Gain | In case of JAN-7201S/9201S, This function is not available by function restriction. | To enable: Select. To disable: Clear. |
| Sea | In case of JAN-7201S/9201S, This function is not available by function restriction. | To enable: Select. To disable: Clear. |
| Rain | In case of JAN-7201S/9201S, This function is not available by function restriction. | To enable: Select. To disable: Clear. |
| [AZ Key] tab | | |
| AZ 1 | When this is selected, AZ1 can be turned On/Off by pressing the AZ key. All checked items can be turned On/Off at once by pressing the AZ key. | To enable: Select. To disable: Clear. |
| AZ 2 | When this is selected, AZ2 can be turned On/Off by pressing the AZ key. All checked items can be turned On/Off at once by pressing the AZ key. | To enable: Select. To disable: Clear. |

16.18 Setting Preferences Information

Select [Preferences] in the classification pane.

The main operation/setting information relating to each task of RADAR and ECDIS can be stored and called collectively.

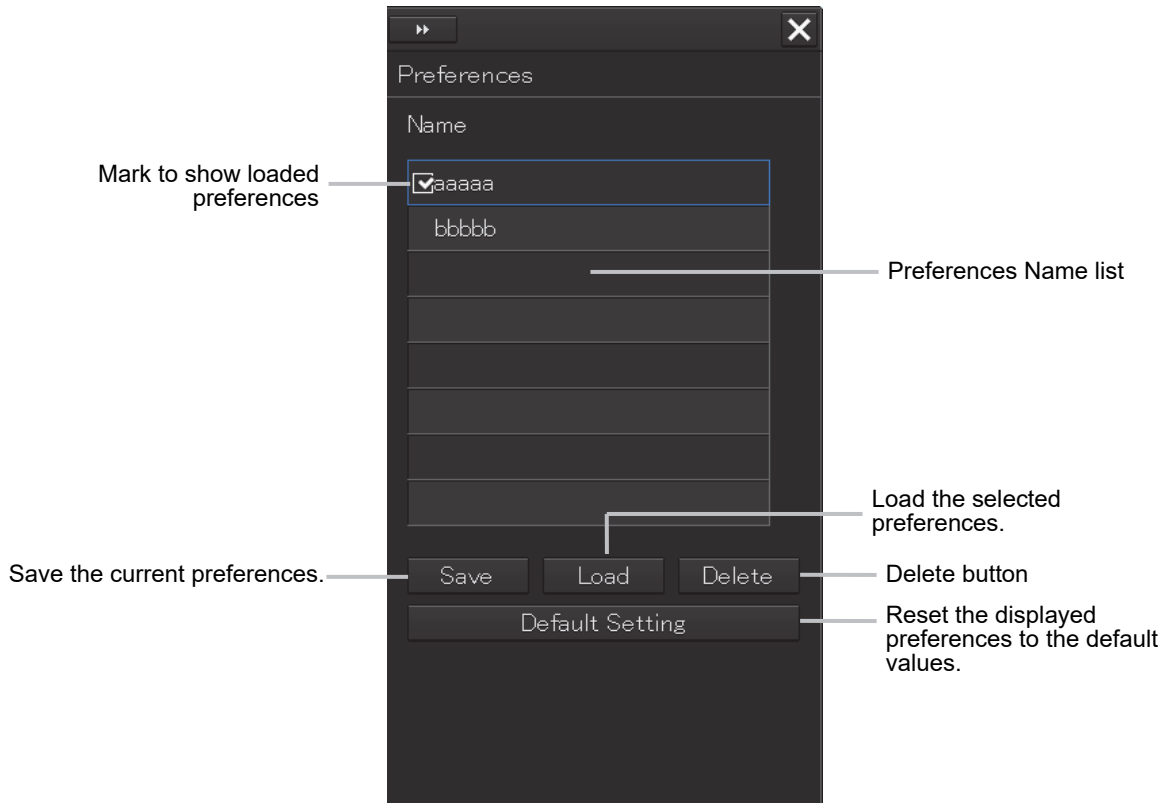

A maximum of 10 preferences names are displayed in the Preferences Name list. If all the file name characters do not fit in the display area, the remaining file name characters will be displayed with an abbreviation symbol (...).

To save a preferences

1 Click on the [Save] button.

The confirmation dialog box appears.

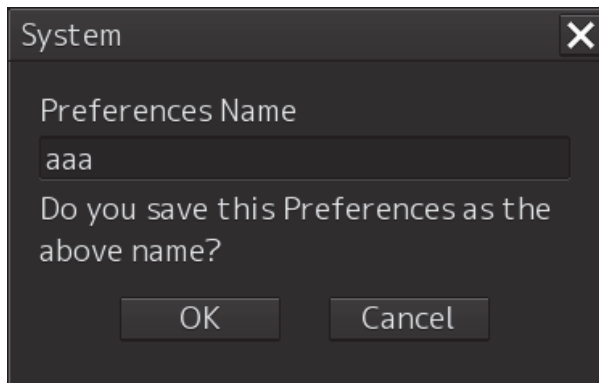

2 Enter a preferences name, and then click on the [OK] button.

The current preferences are saved.

A maximum of 64 characters can be entered for a file name. If all the file name characters do not fit in the display area, the remaining file name characters will be displayed with an abbreviation symbol (...).

To cancel saving, click on the [Cancel] button.

When saving is completed, an item is added to a blank line in the Preferences Name list.

To load preferences

1 Select the name of the preferences you want to load, and then click on the [Load] button.

The confirmation dialog box appears.

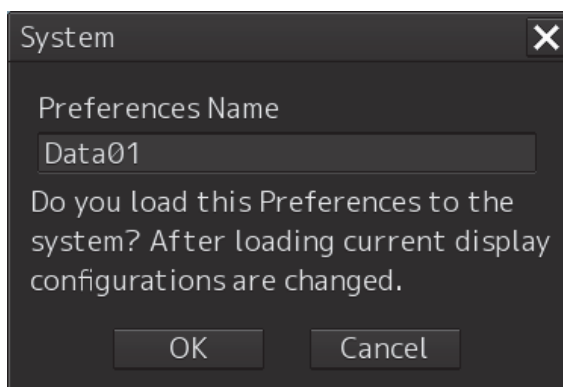

2 Click on the [OK] button.

The selected preferences are loaded.

A maximum of 64 characters can be entered for a file name. If all the file name characters do not fit in the display area, the remaining file name characters will be displayed with an abbreviation symbol (...).

To cancel loading, click on the [Cancel] button.

To delete preferences

- 1 Select the name of the preferences you want to delete, and then click on the [Delete] button.

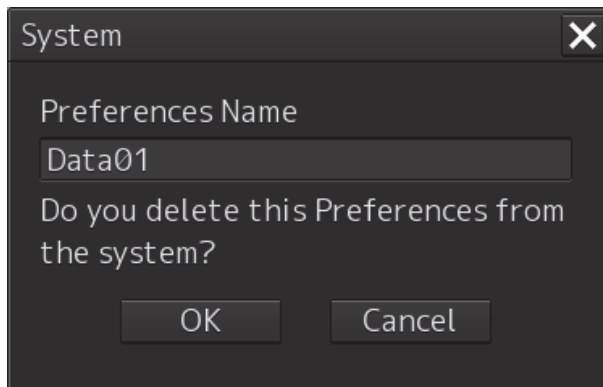

The confirmation dialog box appears. A maximum of 64 characters can be entered for a file name. If all the file name characters do not fit in the display area, the remaining file name characters will be displayed with an abbreviation symbol (...).

- 2 Click on the [OK] button.

The selected preferences are deleted.

To cancel deleting, click on the [Cancel] button.

To set up default display

- 1 Click on the [Default Setting] button.

The confirmation dialog box appears.

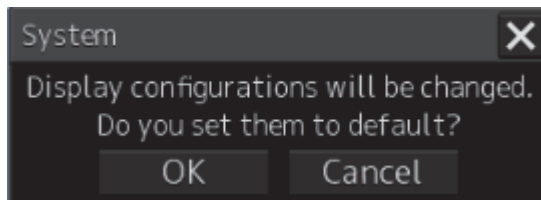

- 2 Click on the [OK] button.

The display configurations are changed to the default values.

To cancel changing, click on the [Cancel] button.

Items of preferences and default display configurations

The items of preferences and default display configurations are shown in the tables below.

Task "Route monitoring"

| Item saved | Preferences save target | | Factory setting value, value and action when Set Default button is pressed |
|-----------------------------|---|---|--|
| | Location | Item | |
| Display category | Chart Information Area | Display category | Standard Display |
| Range | Chart Information Area | Either selection scale or selection range | Range 3 NM |
| Orientation | ECDIS screen - Chart Information Area | <ul style="list-style-type: none"> • Motion mode • Bearing mode | True motion North-up TM reset value |
| position sensor | Common screen - Own Ship Information or Maintenance screen - Sensor Selection | Position source | Continuation |
| Past track | View - Options - Own Track | Past Track display On/Off Plot Color Track Period Time Label display On/Off Time Label Interval Past Position display On/Off Past Position Interval | Past Track display On/Off: On Plot Color: White (Black) *1 Track Period: 12h Time Label display On/Off: On Time Label Interval: 30min Past Position display On/Off: Off Past Position Interval: 0.5min |
| Look-ahead time | Alert - Look-ahead | Area(Rectangle) function On/Off Rectangle Length value Rectangle Length unit Rectangle Width value Area(Sector) function On/Off Sector Width value | Area(Rectangle) function On/Off: On Rectangle Length value: 6min Rectangle Length unit: min Rectangle Width value: 65.6m Area(Sector) function On/Off: On Sector Width value: 45.0° |
| Specail Condition Area | Alert — Specail Condition Area | Priority | Priority: Caution |
| Repetition of UNACK Warning | Alert — CAM | Repetition of UNACK Warning | Time Limit: 60s |
| Area Boundary | View - Options - Chart Common | Area boundary | Plain |

| Item saved | Preferences save target | | Factory setting value, value and action when Set Default button is pressed |
|-------------------|---|---|---|
| | Location | Item | |
| Depth | View - Options - Chart Common | <ul style="list-style-type: none"> • Shallow Contour • Safety Depth • Safety Contour *2 • Deep Contour • For shades • Shallow Pattern Shallow Water Dangers | <ul style="list-style-type: none"> • Shallow Contour: 5 • Safety Depth: Continuation • Safety Contour: Continuation • Deep Contour: 30 • For shades: Off • Shallow Pattern: Off Shallow Water Dangers: On |
| Chart Symbol | View - Options - Chart Common | <ul style="list-style-type: none"> • Chart Symbol • Full Light Line • Consider Scale Minimum | <ul style="list-style-type: none"> • Chart Symbol: Paper Chart • Full Light Line: Off • Consider Scale Minimum: Off |
| Redraw | Setting – Chart | <ul style="list-style-type: none"> • Border Range | <ul style="list-style-type: none"> • Border Range:80 |
| Display of charts | View - Options - Chart Display (ECDIS) | <p>View1</p> <ul style="list-style-type: none"> • Chart Type • Text Size • Group Layer • Layer (Each item) <p>• Text (Each item)</p> <p>View2</p> <ul style="list-style-type: none"> • Text Size • Group Layer • Layer (Each item) <p>Text (Each item)</p> | <p>View1</p> <ul style="list-style-type: none"> • Remain • Text Size: 5 • Group Layer: On • Layer: [S]unknown is ON. Objects below are all OFF: [A]Accuracy [A]Contour label [A]Highlight date dependent [A]Highlight info [A]Highlight document [-]Update Review [A]Nautical publication information • Text: National Language is remain, Important text is On, another objects are Off <p>View2</p> <p>Each item: same setting as View 1</p> |

| Item saved | Preferences save target | | Factory setting value, value and action when Set Default button is pressed |
|-----------------------------|--|--|--|
| | Location | Item | |
| Unit | View —Options—Unit | <ul style="list-style-type: none"> • Current Speed • Wind Speed • Depth | <ul style="list-style-type: none"> • Current Speed: Kn • Wind Speed: Kn • Depth: m |
| Own Ship | View —Options—Own Ship | <ul style="list-style-type: none"> • Sea stabilized vector • Type • Time | <ul style="list-style-type: none"> • Sea stabilized vector: On • Type: Simplified Symbol • Time: 6min |
| Sub Information Area | View —Options—Control | <ul style="list-style-type: none"> • Show Sub Information Window | <ul style="list-style-type: none"> • Show Sub Information Window: Off |
| AIO / T&P | View —Options—AIO / T&P | <ul style="list-style-type: none"> • All AIO Object • All T&P Object | <ul style="list-style-type: none"> • All AIO Object: Off • All T&P Object: Off |
| Chart | Chart —Date Dependent View | <ul style="list-style-type: none"> • Enable Date Dependent View | <ul style="list-style-type: none"> • Enable Date Dependent View: Off |
| Dangerous objects highlight | View —Options—Graphical Indication | <ul style="list-style-type: none"> • Graphical Indication for the Charted Feature object | <ul style="list-style-type: none"> • Graphical Indication for the Charted Feature object:On |
| | | <ul style="list-style-type: none"> • Crossing Safety Contour | <ul style="list-style-type: none"> • Crossing Safety Contour:On |
| | | <ul style="list-style-type: none"> • Navigational Hazards | <ul style="list-style-type: none"> • Navigational Hazards:On |
| | | <ul style="list-style-type: none"> • Prohibited Areas and Areas with Special Conditions | <ul style="list-style-type: none"> • Prohibited Areas and Areas with Special Conditions:On |
| Target past position | View —Options—Own Track | <ul style="list-style-type: none"> • Other shipping routes | <ul style="list-style-type: none"> • Other shipping routes: Off |
| Settings for Route Edit | Settings—Route | <ul style="list-style-type: none"> • XTD(PORT) • XTD(STBD) • Max Latitude | <ul style="list-style-type: none"> • XTD(PORT): Remain • XTD(STBD): Remain • Max Latitude: 85° |
| Brightness | Settings—General—Color and Broghtness—Brightness | <ul style="list-style-type: none"> • Display | <ul style="list-style-type: none"> • Day1/2/3: 67 • Dusk: 60 • Night: 11 |
| Chart Auto Acception | Settings—Chart | <ul style="list-style-type: none"> • AUTO Accepting S-57 Updated Chart | <ul style="list-style-type: none"> • Off |
| Vector(T) length input box | ECDIS—Bottom bar | <ul style="list-style-type: none"> • Vector(T) | <ul style="list-style-type: none"> • 6min |
| Cursor | ECDIS—Cursor Readout | <ul style="list-style-type: none"> • Distance unit | <ul style="list-style-type: none"> • Distance unit: NM |
| MOB | ECDIS —Right Toolbar —MOB | <ul style="list-style-type: none"> • Distance unit | <ul style="list-style-type: none"> • Distance unit: NM |

| Item saved | Preferences save target | | Factory setting value, value and action when Set Default button is pressed |
|---------------|--|---|--|
| | Location | Item | |
| NAVTEX filter | Settings—NAVTEX— Display Filtering for NAVTEX Messages | <ul style="list-style-type: none"> • Station—Display Filtering • Station ID • Month/Year • Message—Display Filtering • Message ID Filtering Depend on Position | <ul style="list-style-type: none"> • Station—Display Filtering: Off • Station ID:Remain • Month/Year:All On • Message—Display Filtering: Off • Message ID: Remain Filtering Depend on Position: Off |

*1 White/Black interchanges under the following conditions.
In Day1/Day2 (or Day), Black, in Day3/Dusk/Night, White

*2 When the preferences is loaded and the value of the Safety Contour that is less than the MIN Safety Contour, the value of the MIN Safety Contour is used as the Safety Contour.
Also, the value of the Safety Contour saved for the preferences is not overwrite.
For details about how to set the Own ship's parameters, refer to "17.3.4 Setting own ship's parameters".

Task "Collision avoidance"

| Item saved | Preferences save target | | Factory setting value, value and action when Set Default button is pressed |
|---------------------------------------|------------------------------------|--|--|
| | Location | Item | |
| Automatic radar target acquisition | Alert - New Target Alarm | <ul style="list-style-type: none"> • AZ1 function On/Off • AZ1 Start Angle value • AZ1 End Angle value • AZ1 Start Distance value • AZ1 End Distance value • AZ2 function On/Off • AZ2 Start Angle value • AZ2 End Angle value • AZ2 Start Distance value • AZ2 End Distance value | <ul style="list-style-type: none"> • AZ1 function On/Off: Off • AZ1 Start Angle value: 315.0° • AZ1 End Angle value: 045.0° • AZ1 Start Distance value: 3.00NM • AZ1 End Distance value: 3.50NM • AZ2 function On/Off: Off • AZ2 Start Angle value: 135.0° • AZ2 End Angle value: 225.0° • AZ2 Start Distance value: 3.00NM • AZ2 End Distance value: 3.50NM |
| Graphical AIS reported target display | View - Options - Target | <ul style="list-style-type: none"> • AIS Symbol display On/Off • Sleeping Class A, Class B | <ul style="list-style-type: none"> • AIS Symbol display On/Off: On • Sleeping Class A, Class B: Off |
| Radar and AIS Target fusion | Settings - TT/AIS - Association | <ul style="list-style-type: none"> • Association function On/Off • TT/AIS Priority | <ul style="list-style-type: none"> • Association function On/Off: On • TT/AIS Priority: AIS |
| AIS Filter | Settings—TT/AIS Common—Filter | <ul style="list-style-type: none"> • Sector Filter • Ring Filter • Ring Filter—Distance | <ul style="list-style-type: none"> • Off • On • 6.00NM |

Another default settings (excepts preference) are below.

| Default Setting Item | Default Setting target | | Factory setting value, value and action when Set Default button is pressed |
|-------------------------|--------------------------------|---|---|
| | Location | Item | |
| Radar image Overlay | ECDIS – Bottom bar | • Radar Echo Image | Radar echo image: Off |
| AIS function button | ECDIS – Bottom bar | • AIS display On/Off | • AIS display: Off |
| TT1/TT2 function button | ECDIS – Bottom bar | • TT1/TT2 display On/Off | • TT1/TT2 display: On |
| Multi View | View – Multiview | • Multi view window other than Single View window | • Multi view window other than Single View window: • Single View |
| Edit User Chart | User Chart Editor | • Edit dialog | • Edit dialog: Exit |
| Edit Manual Update | Manual Update Editor | • Edit dialog | • Edit dialog: Exit |
| Route planning | Route planning dialog | • Edit dialog | • Edit dialog: Exit |
| Route monitoring | Route monitoring dialog | • Route monitoring start • Route monitoring dialog • Voyage Information | • Re-Load latest Route File • Route monitoring dialog: Close • Voyage Information: Move to bottom-right |
| Cursor Readout | Cursor Readout | • Cursor Readout | • Move to bottom-right • Open |
| MOB | MOB | • Cursor Readout | • Move to bottom-right |
| Display of charts | View – Options – Chart Display | • Chart Load | • AUTO |
| Chart Maintenance | Chart Maintenance | • Chart Maintenance dialog | • Chart Maintenance dialog: Exit |
| Selftest | Maintenance – Diagnosis | • Diagnosis dialog | • Diagnosis dialog: Exit |
| CONNING block | Common Information Window | • CONNING block overlay | • CONNING block overlay: Exit |
| Chart 1 | ECDIS display | • Chart drawing (Chart 1 chart) | • Chart drawing (Chart 1 chart): Exit |

16.19 Setting up Screen Capture

Select [Screen Capture] in the classification pane.

Set up the various settings of the screen captures in the setting dialog of the edit pane.

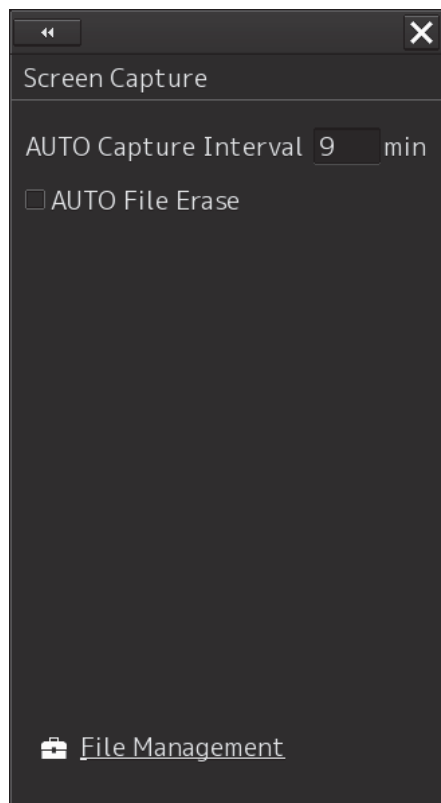

| Setting Item | Description of Setting | Setting Value |
|-----------------------|--|--|
| AUTO Capture Interval | Set up the interval at which the Screen Capture dialog box is automatically saved. If this is set to 0, the Screen Capture dialog box will not automatically be saved. | 0 to 999 min |
| AUTO File Erase | Specify whether or not to delete the screen shot file automatically. | To enable: Select. To disable: Clear. |

| Shortcut | Settings Dialog Box |
|-----------------|------------------------------|
| File Management | [File Management] dialog box |

アスベストは使用しておりません
Not use the asbestos

For further information, contact:



Since 1915

Japan Radio Co., Ltd.

URL Head office : <http://www.jrc.co.jp/eng/>

Marine Service Department

1-7-32 Tatsumi, Koto-ku, Tokyo 135-0053, Japan

e-mail : tmsc@jrc.co.jp

One-call : +81-50-3786-9201

ISO 9001, ISO 14001 Certified